

# DESIGNER

DYNAMIC

## Design Validation Inside Solid Edge

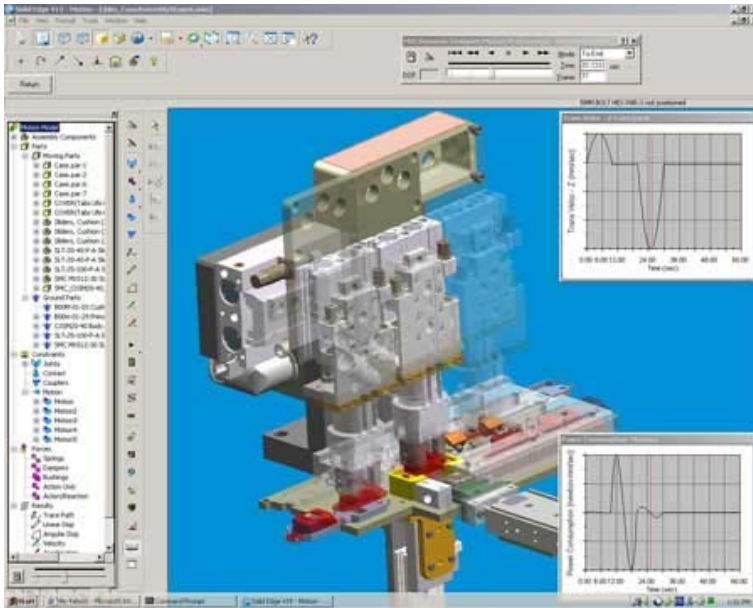

### Generating Design Confidence

Solid Edge allows you to easily create 3D solid models that help you understand the *form* and the *fit* of your design. Once complete, product assembly is easy and frustrating part interferences are now virtually a thing of the past. So everything is perfect, right? Well, not quite. In most situations, you need documented proof that your design will not only work, but withstand a variety of intended (and sometimes unintended) operating conditions. To validate your design, you can perform physical evaluations, either by testing prototypes in a lab, or by field testing the assembled product. No matter which method you choose, each requires several costly and time consuming design changes before you arrive at a design that has both your complete confidence and documented operational proof. There must be a faster, more efficient way.

### Evaluate More Product Designs, Faster

What if you could generate the product confidence you *want* and the operational proof you *require* inside Solid Edge *during* the design process? Before you ever create a physical part or perform a physical test, you could see the effects of each design change and the impact they have on the design's behavior. You would be able to evaluate more design options, faster and at a lower overall cost. To help make "getting it right the first time" more than just a slogan, you need a tool that will help you investigate the *function* of your design at the same time you evaluate form and fit. This is exactly what Dynamic Designer can help you do.

## Motion Simulation Highlights

- **Virtual Design Validation** – Dynamic Designer allows you to calculate “Testing” type results from your existing Solid Edge assembly. Data such as displacements, velocities, accelerations and reaction forces are determined without the time and cost of physical production
- **Easy start up** - Single window integration with Solid Edge means you do not need to transfer geometry to an unfamiliar environment or learn a new user interface.
- **A Product for any budget** - Three product choices: Simply Motion (which already comes with Solid Edge), Motion, and Motion Professional, allows you to choose the level of product that fits your needs today and the ability to expand as your needs change
- **Engineering Versatility** - With a complete set of motion specific objects, Dynamic Designer allows you to solve a broad class of engineering problems. From simple mechanisms with only a few parts to the most complicated assemblies containing gears, cams, latches, and sophisticated contacts and friction can quickly and easily be addressed
- **Effective communication** – Animations of your design's motion, coupled with it's related engineering data, is a powerful way to communicate design functionality across displaced product teams
- **Motion...A Pre-requisite for FEA** - Motion Simulation allows you to generate accurate bearing loads to be used as inputs for Finite Element Analysis
- **Industry proven reliability** - Powered by the MSC.ADAMS™ solver, Dynamic Designer provides you with reliable, accurate, and efficient dynamic motion calculations

## Embedded = Easy to Use

Tailored for the designer or design engineer, Dynamic Designer is completely embedded inside the Solid Edge environment. Being embedded means that start-up or “learning curve” time is very short because the need to learn a new product interface or spend time transferring Inventor geometry to some outside environment is eliminated. By using Dynamic Designer, the process of verifying the function of your design becomes an extension of your existing product design process instead of crossing over into your manufacturing process.

## Motion Simulation: A Simple Process

The process for conducting a motion study inside Solid Edge involves four basic steps:

- Creating the Motion Model
- Adding/Controlling Motion
- Running the Simulation
- Reviewing Results

### **Creating a Motion Model**

Once an assembly is complete, mechanical joints are easily created, either by automatically converting them from your existing assembly constraints using Dynamic Designer’s *Automatic Constraint Mapping*, or by using the unique *Intellimotion builder* which walks you through the step-by-step model building process.

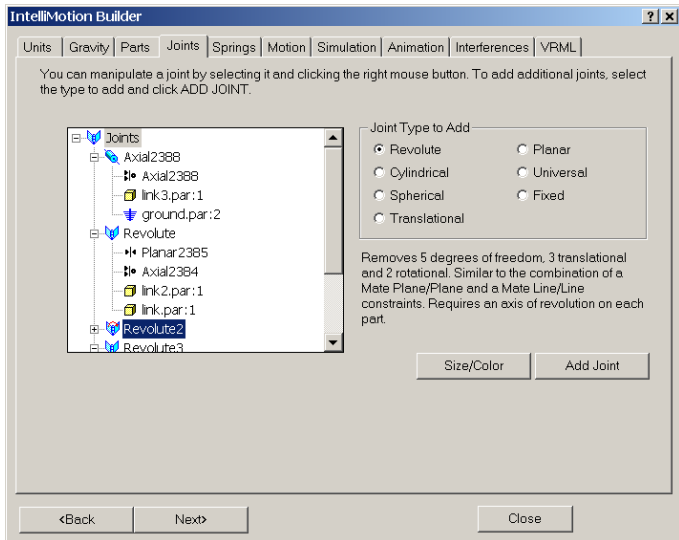

### **Adding and Controlling Motion**

Mechanisms can be controlled in many ways. To make your simulation closely reflect real world functionality, Dynamic Designer allows you to add various motion characteristics to your model. Dynamic Designer supports motors, actuators, gravity, realistic contact between bodies, springs, friction, damping and other generated forces as needed.

## **Simulation**

Running a simulation is as simple as specifying how long you want the process to run and then clicking the calculator icon to compute your motion results.

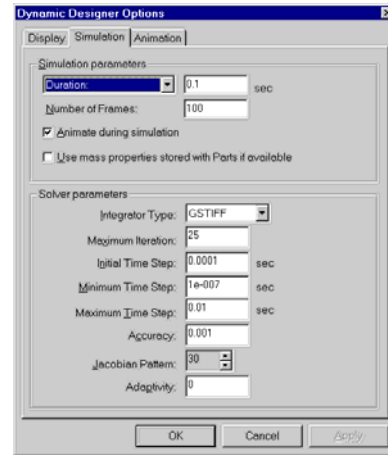

Run Simulation

## **Results**

Dynamic Designer calculates several types of results that you can use to verify the operation of your design. Moving interference animations, AVI and VRML files give you the visual feedback you need to understand if your design will work properly. However, what truly sets Dynamic Designer apart from a general animation package is the ability to provide engineering data associated with the movement of the assembly. Result vectors and plots of displacement, velocity, acceleration and forces, give you the numerical information you need to fully understand the performance of your design. As you make design changes, you can compare the data to verify design improvement.

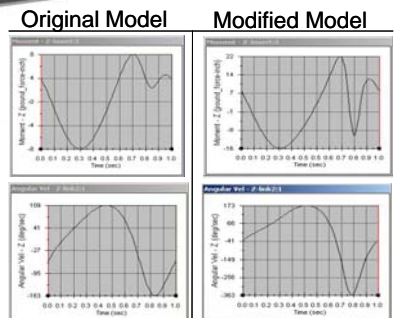
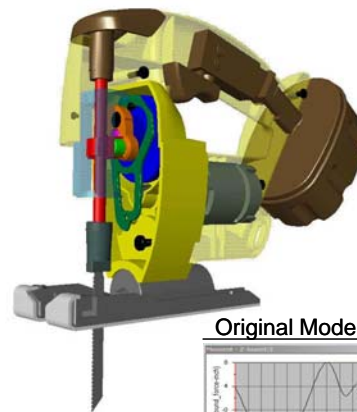

## Motion Simulation – A Prerequisite to FEA

Better inputs = Better outputs. For finite element analysis, accurate inputs are a key factor impacting the quality of the overall finite element results. With Dynamic Designer you are provided with the visual and numerical understanding of how a mechanism will perform, as well as the ability to calculate the forces associated with a mechanism's operation. Loads produced by Dynamic Designer provide more accurate input for use in FE studies thereby improving the overall confidence in finite element analysis.

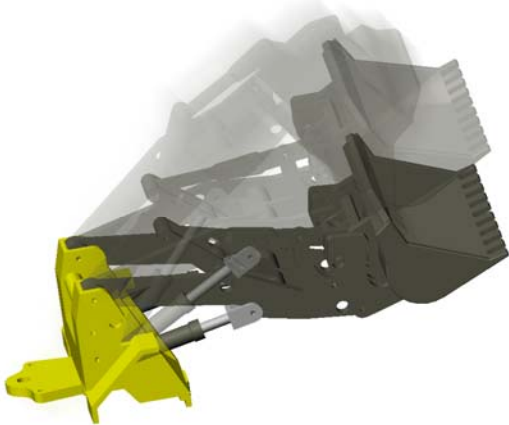

Easily calculate the effects of reaction forces from your mechanism's motion so you can obtain accurate stress results from FEA applications. Dynamic Designer Motion Professional provides you with the most complete simulation environment for modeling and understanding, real world engineering problems in the Solid Edge environment.

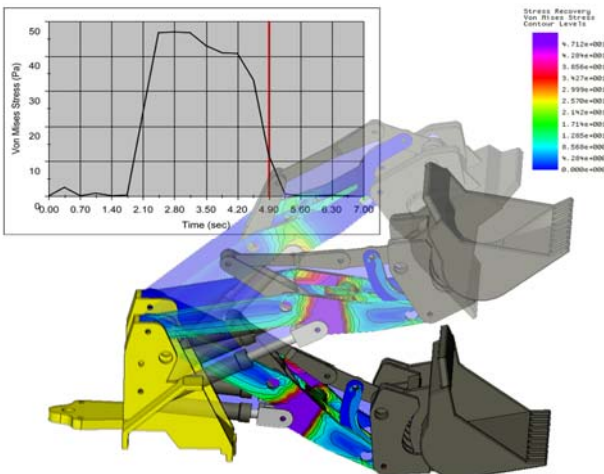

The steps involved in the motion simulation process become an extension of the product development process

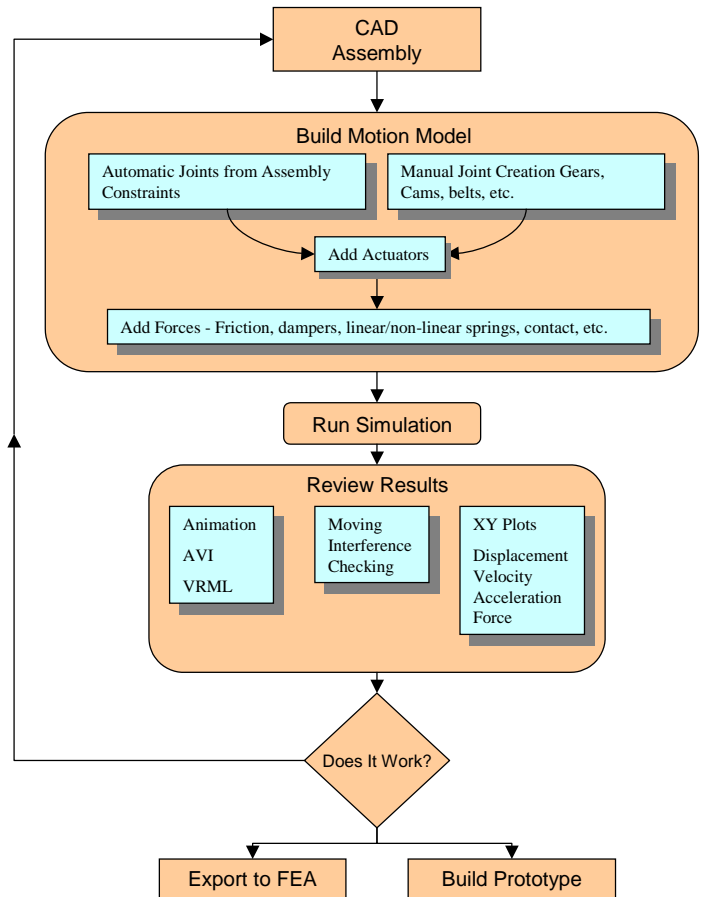

## Dynamic Designer Applications

- Size Motors and Actuators
- Determine how contact and collision effect the operation of a design
- Understand mechanism power consumption
- Determine bearing loads critical to accurate FEA
- Detect part interference throughout range of motion
- Simulate lock and latch operations
- Layout linkages and see how they work
- Design, visualize and investigate gear drive motion
- Create and simulate cam driven mechanisms
- Understand how friction effects operation
- Optimize springs and dampers in a mechanism
- Understand and reduce system vibrations

Try Dynamic Designer Free!  
 Download a 15 Day Evaluation at  
[www.design-simulation.com](http://www.design-simulation.com)

# Dynamic Designer at a glance



Feature	Simply Motion	Motion	Motion Professional
<b>Geometry</b>			
Associative to Motion Model	•	•	•
Automatic mass properties	•	•	•
<b>Joints</b>			
Joints generated from assembly	•	•	•
Revolute, one rotational DOF	•	•	•
Cylindrical, one rotational, one	•	•	•
Spherical, three rotational DOFs	•	•	•
Universal, two rotational DOFs	•	•	•
Translational, one translational DOF	•	•	•
Planar, two translational, one rota-	•	•	•
Fixed, restrains all DOFs	•	•	•
Screw, Rotary to linear	•	•	•
Inline		•	•
Inplane		•	•
Orientation		•	•
Parallel Axis		•	•
Perpendicular		•	•
Supports Friction			•
Joint Couplers		•	•
<b>Contact</b>			
Point on Curve constraint		•	•
Curve to Curve constraint		•	•
Curve to Curve 2D		•	•
General 3D surface		•	•
Contact Containers		•	•
<b>Motion Generators</b>			
Add motion to joints	•	•	•
Add motion to a part		•	•
<b>Forces</b>			
Isotropic Bushings			•
Orthotropic Bushings			•
Linear and torsion springs	•	•	•
Linear and torsion dampers			•
Action-only force and moment			•
Action/reaction force and moment			•
Point to point impact force			•
Animated/Rendered 3D Springs		•	•
<b>Motion and Forcing Functions</b>			
Constant	•	•	•
Harmonic	•	•	•
Step	•	•	•
Read in Data Points	•	•	•
MSC.ADAMS Functions			•
<b>Simulation</b>			
Kinematic	•	•	•
Dynamic	•	•	•
Dynamic Dragging	•	•	•
<b>Results</b>			
Animation	•	•	•
Moving interference checking	•	•	•
Find first point of interference	•	•	•
Animation to AVI	•	•	•
Animation to VRML	•	•	•
<b>Calculated Results</b>			
Linear displacement		•	•
Angular displacement		•	•
Velocity		•	•
Acceleration		•	•
Reaction forces and moments			•
Animated Results Vectors for Veloc-		•	•
Animated Results Forces Vectors			•
Internal results plotting		•	•
Export data to CSV and Excel		•	•
Display multiple plots		•	•
Minimum distance calculation	•	•	•
<b>Interfaces</b>			
Universal FEA Export file			•
MSC.ADAMS			•
Dynamic Designer Automation API			•
Network (Floating) license		•	•

## Compare Capabilities

Not sure which Dynamic Designer product best suits your needs? Review the table to the right to compare the various product capabilities.

## Learn About Motion Simulation

To learn more about motion simulation, or how Dynamic Designer may help your product design process, contact your Inventor dealer, visit the web site at [www.design-simulation.com](http://www.design-simulation.com) or contact a DST representative at 734.678.9026.

## Try it Free

To help you understand the positive impact that motion simulation can have on your product design process, make sure you download a free trial copy of Dynamic Designer by visiting



Design, visualize, and investigate gear-drive motion

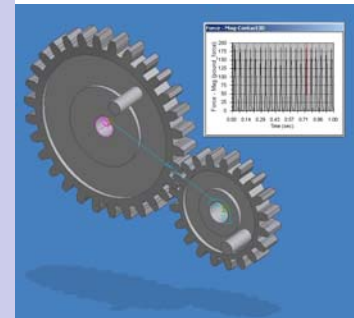

Investigate how friction effects system motion

WWW.DESIGN-SIMULATION.COM

Design Simulation Technologies, Inc.  
43311 Joy Road, #237 Canton, MI 48187 USA  
Tel: +1-734-446-6935 Fax: +1-734-446-6938  
[info@design-simulation.com](mailto:info@design-simulation.com)

Try it Free! - [www.design-technologies.com](http://www.design-technologies.com)