

# STEP APPLICATION HANDBOOK

## ISO 10303

### VERSION 3

30 June 2006

*The overall objective of STEP is to provide a mechanism that describes a complete and unambiguous product definition throughout the life cycle of a product, independent of any computer system. This Handbook is a reference document available to the development and user community at large. It provides information on the use of STEP to exchange and archive product data as well as the ISO standardization process.*

PREPARED BY:



5300 INTERNATIONAL BOULEVARD.  
NORTH CHARLESTON, SC 29418

©Copyright 2006 by SCRA

Authorization to photocopy this document for general dissemination in the original form, that is, without alteration, changes, modifications, or revisions to its contents, is permitted. All other rights reserved by SCRA.

## Foreword

The development and implementation of Standard for the Exchange of Product model data (STEP) is dynamic and on-going. "STEP" is actually a series of standards, developed by experts worldwide, under the auspices of ISO 10303, Technical Committee (TC) 184, Sub-Committee (SC) 4. A handbook such as the following represents a "snap shot" of the information as it exists at this point in time.

This handbook, which updates the previous versions of the STEP Application Handbook (See APPENDIX A - Documents), concentrates on identifying the application domains being covered by STEP development, identifying commercially available tools for using STEP, and providing guidance on using the STEP technology that is currently available. It updates those STEP Application Protocols (AP's) that have achieved (or "very soon" will achieve) International Standard (IS) status, those AP's that are currently active (or about to be activated), those AP's that are currently implemented and have commercially available translators, and those AP's that have been or are currently being piloted, prototyped, or proved-out.

This handbook is intended as an updated collection of information on the current state of STEP and its current usability. It is intended to provide information of value to engineering users with a need to exchange product data with customers and/or suppliers.

An attempt has been made to distinguish between what is "real" now and what is theoretically possible in the future and to identify some of the current obstacles to achieving the ultimate goal of STEP. (i.e., to provide a complete, unambiguous, neutral computer-interpretable standard for representing product data throughout the lifecycle of the product)

### SPONSOR

The sponsor and funding agency for this Version 3 update of the STEP Application Handbook is the National Automotive Center, U.S. Army Tank-Automotive Research, Development and Engineering Center. SCRA authorized the update under TACOM Contract No. DAAEO7-03-C-LO89. This Handbook is available for free download on three websites: SCRA/ISG (<http://isg-scra.org/>), U.S. Product Data Association (<https://www.uspro.org/>), and SC4 On-Line Information Service (<http://www.tc184-sc4.org/>).

## **Acknowledgements**

Much information has been extracted from the many STEP related Web Sites. An attempt has been made to identify the source of most of the information, but in many instances overlapping information came from multiple sources. The information in the tables is a compilation of information from many sources. Numerous web sites are listed in the body of the handbook and in the Appendix B along with the documents Appendix A. Many of the references were the sources of much of this information; some of them are simply listed for further reading beyond the intent of this document.

Particularly helpful were the PDES, Inc. Public Web Site, the SC4 Web Site , the Theorem Solutions Web Site, the UK Council for Electronic Business (UKCEB) Web Site, the Naval Surface Warfare Center, Carderock Division and the U.S. Product Data Association Sites.

## **Abstract/Executive Summary**

### Purpose:

Organizations can not do e-commerce if the technical drawings are “in the mail”. Digital technical data standards are a cornerstone of e-business. If we are going to do “commerce at light speed”, the use of neutral digital technical data standards is one of the requirements. The STandard for the Exchange of Product model data (STEP) is an International Organization for Standardization (ISO) product model data exchange standard (identified as ISO 10303) that is designed to meet this need.

This handbook is intended as a collection of information on the current state of STEP and it’s current usability. "STEP" is actually a series of standards, developed by experts worldwide, under the auspices of ISO 10303/TC184/SC4. It is intended to provide information of value to engineering users with a need to exchange product data with customers and/or suppliers.

The handbook concentrates on identifying the application domains being covered by STEP development, identifying commercially available tools for using STEP, providing guidance on using the STEP technology that is currently available, and providing sources of additional information.

### Content:

The handbook presents a brief introduction to STEP along with an indication of how the ISO Standardization Process works relative to STEP. The reader is made aware of the current status of STEP development with emphasis on those parts of STEP that have achieved International Standard (IS) status and those parts that will soon reach that status. The scope of each STEP Application Protocol (AP) is presented to indicate what is and what isn't addressed in the AP's. This information is presented so that the engineering user is able to see the depth of coverage of the AP's and to identify those STEP AP's and their associated conformance classes that best will meet the user's product data exchange (PDE) requirements.

A table is provided showing commercially available PDE translators from the major CAD/CAM vendors. This table includes STEP translators as well as direct translators and translators that use other PDE formats.

At this point in time, commercial implementation of STEP is still pretty much limited to several conformance classes of AP203 - Configuration Controlled Design and two conformance classes of AP214 - Core Data for Automotive Mechanical Design Processes which are roughly equivalent to AP203. Reference is made to those major companies who have put this current STEP capability into production.

Despite the limited coverage of STEP AP's in the commercial marketplace, there are (and have been) numerous pilot, prototype and proof-of-concept implementations of the many STEP Application Protocols as they have been evolving through the stages of ISO standardization. Many of these pilot projects are cited in the handbook to emphasize the successful demonstration of the power and robustness of the evolving STEP standards.

An attempt has been made to distinguish between what is “real” now and what is theoretically possible (& achievable) in the future and to identify some of the current obstacles to achieving the ultimate goal of STEP. (i.e., to provide a complete, unambiguous, neutral computer-interpretable standard for representing product data throughout the lifecycle of the product.)

Some guidance is provided for the engineering user in using the currently available STEP capability. Many obstacles have been overcome and many lessons have been learned in bringing this "first phase" of STEP implementation into production. Some hints, guidelines and checklists are provided and referenced to assist in using the currently available STEP technology.

Summary:

The STEP-related product that is commercially available to the engineering user community is essentially AP203 and its "look alike" AP214 cc 1&2 (i.e., geometry (wireframe, surfaces & solids) with some configuration management data). What is available is really very good --- good enough to be in production at Boeing, Lockheed Martin, General Motors, General Electric, Pratt & Whitney, Rolls Royce, Electric Boat, Northrop Grumman and other large companies and government facilities. But STEP presents a much more powerful and robust technology beyond that currently implemented and this is being demonstrated in numerous Research & Development environments.

STEP is still evolving and is now at a point in its evolution when a significant number of Application Protocols have achieved International Standard status. There are now 22 STEP Application Protocols that are International Standards and others that are steadily moving toward that status. STEP is and will be more than AP203. The user community needs to start looking more closely at the AP's and their associated conformance classes (cc's) to determine what components/parts of STEP best meet their requirements. The user further needs to begin referring to STEP by AP and cc. In order to realize the "full" power of STEP, the user community will have to drive vendor implementation of the AP conformance classes that meet their business objectives. In order for this to happen, strong business cases are going to have to be developed in order to get the CAD/CAM/CAE Vendors on board.

# Table of Contents

<b>1 INTRODUCTION</b> .....	<b>10</b>
<b>2 BACKGROUND</b> .....	<b>11</b>
2.1 ISO 10303 (STEP) OVERVIEW .....	11
2.2 EXISTING/ACTIVE STEP APPLICATION PROTOCOLS .....	13
2.3 INTERNATIONAL HARMONIZED STAGE CODES .....	15
2.3.1 <i>Examples of the principal abbreviations used in the technical program</i> .....	16
2.4 COMMENTS ON STEP AP'S, AIC'S, AM'S AND RPG'S .....	17
2.4.1 <i>Application Interpreted Construct</i> .....	17
2.4.2 <i>Application Module</i> .....	18
2.5 STEP AND XML, STEPML, IMPLEMENTATION METHODS .....	29
2.5.1 <i>Parts 21, 25 &amp; 28</i> .....	30
2.6 SCOPES AND CONFORMANCE CLASSES OF APPLICATION PROTOCOLS (AP) WITH IS STATUS .....	34
2.6.1 AP201 .....	35
2.6.2 AP202 .....	36
2.6.3 AP203 .....	38
2.6.4 AP204 .....	41
2.6.5 AP207 .....	43
2.6.6 AP209 .....	45
2.6.7 AP210 .....	47
2.6.8 AP212 .....	54
2.6.9 AP214 .....	56
2.6.10 AP215 .....	61
2.6.11 AP216 .....	63
2.6.12 AP218 .....	64
2.6.13 AP224 .....	67
2.6.14 AP225 .....	68
2.6.15 AP227 .....	71
2.6.16 AP232 .....	76
2.6.17 AP239 .....	79
2.6.18 AP240 .....	82
2.7 SCOPES OF AP'S THAT ARE "SOON TO BE" INTERNATIONAL STANDARDS: .....	84
2.7.1 AP219 .....	84
2.7.2 AP221 .....	85
2.7.3 AP236 .....	89
2.7.4 AP238 .....	89
2.8 SCOPES OF AP'S THAT ARE "IN PROCESS" .....	92
2.8.1 AP223 .....	92
2.8.2 AP229 .....	94
2.8.3 AP233 .....	95
2.8.4 AP235 .....	97
2.9 STEP APPLICATION SUITES .....	98
2.9.1 <i>Manufacturing Suite</i> .....	99
2.9.2 <i>Shipbuilding Suite</i> .....	113
2.9.3 <i>Eletromechanical Suite</i> .....	117
2.9.4 <i>Process Plant Suite</i> .....	121
2.9.5 <i>Systems Engineering Suite</i> .....	122
2.9.6 <i>Engineering Analysis Core Model</i> .....	125
2.9.7 <i>Product Life Cycle Support (PLCS)</i> .....	127
2.10 OVERVIEW .....	127
2.11 DATA EXCHANGE SETS (DEX) .....	127
2.12 THE CONTENTS OF A DEX .....	127
2.13 CURRENT SET OF DEXS .....	128

2.14 BACKGROUND TO PLCS INC .....	128
2.15 PLCS OASIS TECHNICAL SUBCOMMITTEE .....	128
2.16 SPONSORS .....	128
2.16.1 <i>funSTEP</i> .....	129
<b>3 OTHER PRODUCT DATA EXCHANGE SPECIFICATIONS &amp; STANDARD .....</b>	<b>131</b>
<b>4 COMMERCIAL PRODUCTS AND SERVICES .....</b>	<b>133</b>
4.1 CAD/CAM/CAE VENDOR STEP CAPABILITIES .....	133
4.2 DIRECT TRANSLATORS, SERVICES, AND TOOLS .....	143
4.2.1 <i>Direct Translators</i> .....	143
4.2.2 <i>Translation Services</i> .....	143
4.2.3 <i>Solid Modelers</i> .....	144
4.2.4 <i>STEP Tool Vendors</i> .....	144
<b>5 PILOTS &amp; PROTOTYPES .....</b>	<b>145</b>
<b>6 PRODUCTION IMPLEMENTATIONS OF STEP .....</b>	<b>151</b>
6.1.1 <i>DFX Tool Overview</i> .....	153
6.1.2 <i>Production Deployment at Rockwell Collins, Inc. (RCI)</i> .....	154
<b>7 GUIDANCE ON USING STEP .....</b>	<b>155</b>
<b>8 STEP TRANSLATOR IMPLEMENTORS FORUM .....</b>	<b>158</b>
<b>9 SUMMARY .....</b>	<b>159</b>
<b>10 APPENDICES .....</b>	<b>161</b>
10.1 APPENDIX A - DOCUMENTS .....	161
10.2 APPENDIX B – WEB SITES .....	163
10.3 APPENDIX C – STEP ON A PAGE .....	165
10.4 APPENDIX D – SCOPES FOR ISO 14649 PARTS .....	173

## Figures

Figure 1— Contrasting the AP architectures .....	19
Figure 2 — Example of a STEP Part 21 file .....	31
Figure 3 — APs using Machining features .....	100
Figure 4 — Example of complete circular path with V profile .....	101
Figure 5 — Hole bottom types .....	102
Figure 6 — Machining feature example .....	103
Figure 7 — A STEP Manufacturing Suite .....	105
Figure 8 — AP224 .....	106
Figure 9 — AP240 .....	108
Figure 10 — AP238 .....	109
Figure 11 — AP223 Casting Features .....	111
Figure 12 — AP219 .....	112
Figure 13 — System Project Management .....	123
Figure 14 — Conceptual Data Model for System Specification & Design .....	124
Figure 15 — Product Life Cycle Support .....	129
Figure 16 — System architecture .....	149

Figure 17 — Prototype AP210 3-D Package Modeler .....	151
Figure 18 — Rule Result Browsing Interface.....	153
Figure 19 — DFX Process Flow.....	154

## Tables

Table 1 — List of Acronyms .....	iii
Table 2 — Proprietary Names of Vendors and Products.....	viii
Table 3 — STEP Application Protocols .....	13
Table 4 — ISO Stage Codes .....	15
Table 5 — ISO Stage Abbreviations .....	16
Table 6 — Application Interpreted Construct .....	18
Table 7 — Application Modules.....	20
Table 8 — AP203 modules.....	40
Table 9 — AP239 modules.....	81
Table 10 — AP221 Modules .....	87
Table 11 — CAD Vendors with STEP Capabilities.....	134
Table 12 — Vendors with other STEP Capabilities .....	140



**Table 1 — List of Acronyms**

<b>Acronyms</b>	<b>Definition</b>
<b>2D</b>	Two Dimensional
<b>3D</b>	Three Dimensional
<b>ABS</b>	American Bureau of Shipping
<b>ACORN</b>	Advanced Control Network
<b>AEA</b>	Aerospace Engine Alliance - AP203/PDM Schema
<b>AEC</b>	Architecture, Engineering, Construction
<b>AES</b>	Atlantec Enterprise Solutions
<b>AFNOR</b>	Association Française de NORmalisation (French Standards Organization)
<b>AIAG</b>	Automotive Industries Action Group
<b>ANAD</b>	ANniston Army Depot
<b>ANSI</b>	American National Standards Institute
<b>ARDEC</b>	Armament Research, Development and Engineering Center
<b>ASME</b>	American Society of Mechanical Engineers
<b>ATI</b>	Advanced Technology Institute
<b>ATP</b>	Advanced Technology Program (NIST)
<b>AWS</b>	Advanced Weapon System (AP203/AP202)
<b>B-Rep</b>	Boundary Representation
<b>Brite EuRam</b>	A research program on raw materials and advanced materials
<b>BSI</b>	British Standards Institute
<b>CAD</b>	Computer Aided Design
<b>CAE</b>	Computer Aided Engineering
<b>CALS</b>	Computer Aided Logistics Support Computer-Aided Acquisition & Logistics Support Continuous Acquisition and Life-cycle Support Commerce At Light Speed
<b>CALYPSO</b>	Computational Fluid Dynamics in the Ship Design Process
<b>CAM</b>	Computer Aided Manufacturing
<b>CAMP</b>	Cleveland Advanced Manufacturing Partnership
<b>CAPP</b>	Computer Aided Process Planning
<b>CAx</b>	Generic name for CAD/CAM/CAE
<b>CCITT</b>	Consultative Committee International for Telegraphy & Telephony (ISO)
<b>CEB</b>	Containment Early Binding
<b>CEC</b>	Center for Electronic Commerce (at ERIM)
<b>CIM</b>	Computer Integrated Manufacturing
<b>CIMSTEEL</b>	Computer Integrated Manufacture for constructional STEELwork - AP230
<b>CLDATA</b>	Cutter Location Data
<b>CM</b>	Configuration Management
<b>CMM</b>	Coordinate Measuring Machine
<b>CNC</b>	Computerized Numerical Control
<b>COTS</b>	Commercial Off-The-Shelf
<b>CSG</b>	Constructive Solid Geometry
<b>DARPA</b>	Defense Advanced Research Program Agency
<b>DDE</b>	Data Definition Exchange
<b>DIN</b>	Deutsches Institut für Normung (German Standards Organization)
<b>DL</b>	Data List(AP232)

<b>Acronyms</b>	<b>Definition</b>	
<b>DLA</b>	Defense Logistics Agency	
<b>DoD</b>	Department of Defense	
<b>DXF</b>	Data eXchange Format (Public Domain from Autodesk)	
<b>DTD</b>	Document Type Definition	
<b>DWG</b>	DraWinG format (Public Domain from Autodesk)	
<b>ECRC</b>	Electronic Commerce Resource Center	
<b>EDIF</b>	Electronic Design Interchange Format (ANSI/EIA)	
<b>EDIMAR</b>	Electronic Data Interchange for the European Maritime Industry	
<b>EDM</b>	Electrical Discharge Machining	
<b>EIA</b>	Electronic Industries Association	
<b>EMSA</b>	European Marine STEP Association	
<b>ERIM</b>	Environmental Research Institute of Michigan	
<b>EPISTLE</b>	European Process Industries STEP Technical Liaison Executive (AP221)	
<b>ESPRIT</b>	European Commission - Specific RTD Programme in the field of Information Technologies	
<b>ESTEP</b>	Evolving STEP	
<b>FEA</b>	Finite Element Analysis	
<b>FEM</b>	Finite Element Modeling	
<b>FunSTEP</b>	Furniture STEP	
<b>GALIA</b>	Groupement pour l'Amelioration des Liaisons dans l'Industrie Automoblie (French)	
<b>GDLS</b>	General Dynamics Land Systems	
<b>GM</b>	General Motors	
<b>GOSET</b>	Operational Group for the Standard for Exchange and Transfer (French)	
<b>GSCAD</b>	Global Shipworks CAD (an Intergraph CAD System)	
<b>IAV</b>	Interim Armored Vehicle	
<b>IDL</b>	Indentured Data List (AP232)	
<b>IEC</b>	International Electrotechnical Commission	
<b>IEEE</b>	Institute of Electrical and Electronics Engineers	
<b>IGES</b>	Initial Graphics Exchange Specification (ANSI/ASME)	
<b>IL</b>	Index List (AP232)	
<b>IMS</b>	Integrated Manufacturing Systems	
<b>INCOSE</b>	International Council On System Engineering	
<b>IPC</b>	Institute for interconnecting and Packaging electronic Circuits (ANSI)	
<b>IPO</b>	IGES/PDES Organization	
<b>ISAP</b>	International STEP Automotive Project	
<b>ISDP</b>	Integrated Ship Design & Production (an Intergraph Suite of Products)	
<b>ISE</b>	Integrated Shipbuilding Environment	
<b>ISEC</b>	Integrated Shipbuilding Environment Consortium	
<b>ISO</b>	International Organisation for Standardisation	
	AWI	Approved Work Item
	CD	Committee Draft
	DIS	Draft International Standard
	FDIS	Final Draft International Standard
	IS	International Standard
	JWG	Joint Working Group
	NWI	New Work Item
	PWI	Preliminary Work Item

<b>Acronyms</b>		<b>Definition</b>
	SC	Sub Committee
	TC	Technical Committee
	WG	Working Group
<b>ITI</b>		International TechneGroup, Inc.
<b>JAMA</b>		Japanese Automotive Manufacturers Association
<b>JECALS</b>		Japan EC/CALS
<b>JEDMICS</b>		Joint Engineering Data Management Information & Control System
<b>JMSA</b>		Japan Marine Standards Association
<b>JSTEP</b>		Japan STEP promotion center
<b>KCS</b>		Kockums Computer Systems
<b>KRISO</b>		Korean Research Institute of Ships and Ocean engineering
<b>KS-STEP</b>		Korean Ship – STEP
<b>KPSI</b>		Kvaerner Philadelphia Shipbuilding, Inc.
<b>LM-TAS</b>		Lockheed Martin - Tactical Aircraft Systems
<b>MariSTEP</b>		MariTech STandard for Product Model Exchange
<b>MATINF</b>		MATerial INformation
<b>MOF</b>		Meta-Object Facility
<b>MoD</b>		Ministry of Defence
<b>MOSys</b>		Models for Operational reliability, integrity, and availability analysis of ship machinery Systems
<b>MOU</b>		Memorandum of Understanding
<b>NAC</b>		National Automotive Council
<b>NASA</b>		National Aeronautics and Space Administration
<b>NASSCO</b>		<u>N</u> ational <u>S</u> teel and <u>S</u> hipbuilding <u>C</u> ompany
<b>NAVSEA</b>		NAVal SEA systems command
<b>NC</b>		Numerical Control
<b>NIST</b>		National Institute of Standards and Technology
<b>NSRP</b>		National Shipbuilding Research Program
<b>N-STEP</b>		<u>N</u> AC-STEP Enabled <u>P</u> roduction of components
<b>NURBS</b>		Non-Uniform Rational B-Splines
<b>NWI</b>		New Work Item
<b>ODM</b>		On Demand Manufacturing
<b>OL</b>		Other List(AP232)
<b>OMG</b>		Object Management Group
<b>OSEB</b>		Object Serialization Early Binding
<b>PAS-C</b>		PDES Application protocol Suite for Composites
<b>PDE</b>		Product Data Exchange
<b>PDES</b>		Product Data Exchange using STEP
<b>PDES, Inc.</b>		United States/United Kingdom Consortium for Accelerating the Development and Implementation of STEP
<b>PDM</b>		Product Data Management
<b>PDS</b>		Product Data Set
<b>PdXi</b>		Process data eXchange Institute (AP231)
<b>PIEBASE</b>		Process Industry Executive for achieving Business Advantage using Standards for data Exchange (AP221, AP227, AP231)
<b>PIPPIN</b>		Pilot Implementation of Process Plant Lifecycle Data Exchange Conforming to STEP - AP221

<b>Acronyms</b>		<b>Definition</b>
<b>PISTEP</b>		Process Industries STEP - AP221 & AP227
<b>PL</b>		Parts List(AP232)
<b>PLCS</b>		Product Life Cycle Support
<b>PLSSPD</b>		Parts Library and STEP for Shipbuilding Product Data
<b>PM</b>		Product Management
<b>POSC</b>		Petrotechnical Open Software Corporation
<b>POSC/Caesar</b>		Petrotechnical Open Software Corporation & Caesar Systems, Ltd
<b>PreAMP</b>		Pre-Competative Advanced Manufacturing Program
<b>ProSTEP</b>		The Centre for STEP in Germany
<b>R&amp;D</b>		Research and Development
<b>RAMP</b>		Rapid Acquisition of Manufactured Parts
	DCVE	Data Conversion & Verification Environment
	GAPP	Generative Assembly Process Planning
	PCA	Printed Circuit Assembly
	PCB	Printed Circuit Board
	STEPPlan	STEP Process Planner
	STEPTrans	STEP Translator
	STEPValidator	STEP Validator
<b>RPG</b>		Recommended Practice Guide
<b>SASIG</b>		STEP Automotive Special Interest Group (AIAG, GALIA, VDA, JAMA)
<b>SC</b>		Sub-Committee
<b>SE</b>		System Engineering
<b>SEASPRITE</b>		Software architectures for ship product data integration and exchange
<b>SEDRES</b>		System Engineering Representation and Exchange Standardization
<b>SCRA</b>		South Carolina Research Authority
<b>SEDS</b>		SC4 Enhancement and Discrepancy System
<b>SET</b>		Standard d'Exchange et de Transfert (French) (AFNOR)
<b>SGML</b>		Standard Generalized Mark-up Language
<b>SIS</b>		Stereolithography Interface Specification (Public Domain from 3D Systems, Inc.)
<b>SMS</b>		STEP Manufacturing Suite
<b>SOAP</b>		STEP On A Page Simple Object Access Protocol
<b>SOLIS</b>		SC4 On-Line Information System
<b>SPI-NL</b>		Standard for Plant Information in the NetherLands
<b>STAMP</b>		Supply-chain Technologies for Affordable Missile Products - AP232/STEP PDM Schema
<b>STL</b>		Stereolithography
<b>STEP</b>		<u>S</u> Tandard for the <u>E</u> xchange of <u>P</u> roduct model data (ISO)
	AAM	Application Activity Model
	AIC	Application Interpreted Construct
	AIM	Application Interpreted Model
	AM	Application Module
	AO	Application Object
	AP	Application Protocol
	AR	Application Resource
	ARM	Application Resource Model
	ATS	Abstract Test Suite

<b>Acronyms</b>	<b>Definition</b>
CC	Conformance Class
IR	Integrated Resource
SDAI	Standard Data Access Interface
UoF	Unit of Functionality
<b>STEPwise</b>	STEP web integrated supplier exchange pilot
<b>STIR</b>	STEP TDP Interoperability Readiness pilot
<b>TACOM</b>	Tank automotive and Armament COMmand
<b>TAG</b>	Technical Advisory Group
<b>TARDEC</b>	U.S. Army Tank-Automotive Research, Development and Engineering Center
<b>TC</b>	Technical Committee
<b>TDP</b>	Technical Data Package
<b>TIGER</b>	Team Integrated-Electronic Response
<b>TS</b>	Technical Specification
<b>UML</b>	Unified Modeling Language
<b>USPro</b>	U. S. Product data association
<b>UK</b>	United Kingdom
<b>UKCEB</b>	UK Council for Electronic Business
<b>UKRAMP</b>	United Kingdom RAMP
<b>VAST</b>	Validating Advanced Supply-chain Technology
<b>VDA-IS</b>	Verband der Automobilindustrie - German Standard to exchange 2D CAD Geometry & dimensions (DIN)
<b>VDA-FS</b>	Verband der Automobilindustrie - German Standard to exchange Surface Data (DIN)
<b>VHDL</b>	Very High Speed Integrated Circuit (VHSIC) Hardware Description Language (ANSI/IEEE)
<b>W3C</b>	World Wide Web Consortium
<b>XMI</b>	XML Metadata Interchange
<b>XML</b>	eXtensible Markup Language

**Table 2 — Proprietary Names of Vendors and Products**

<b>Product/Vendor</b>	<b>Description</b>
<b>ACIS</b>	Geometric Modeling Kernel supporting 3D surfaces and BREP solids
<b>AutoCAD</b>	A CAD system developed and marketed by Autodesk
<b>Autodesk</b>	A CAD/CAM system developer and vendor - Develops and markets AutoCAD and Mechanical Desktop
<b>Bentley</b>	A Company that develops and markets CAD/CAM Software
<b>Board Station</b>	A CAE system for Printed Circuit Board (PCB) layout design developed and marketed by Mentorgraphics
<b>Bravo</b>	A CAD system developed by Applicon (now part of UGSolutions)
<b>CADDS 4X/CADDS5</b>	CAD systems developed by Computervision
<b>Cadence</b>	An Electrical/Electronic CAE System Vendor
<b>CADKEY</b>	A CAD system developed and marketed by CADKEY Corporation
<b>Camand Mutax</b>	A CAM system (formerly CAMAX) developed and marketed by SDRC
<b>CATIA</b>	A CAD system developed and marketed by Dassault Systemes & IBM
<b>Computervision</b>	A company, now, within Parametric Technology Corporation
<b>Dassault Systemes</b>	A French CAD/CAM Company that develops and markets CATIA and SolidWorks
<b>Eagle</b>	A PC based ECAD System
<b>ECCO</b>	An EXPRESS Compiler developed and marketed by PDTEC
<b>EDM</b>	An EXPRESS Compiler developed and marketed by EPM
<b>EPM</b>	A Norwegian Product Data Modeling Software Company
<b>EXPRESS Data Manager</b>	A Suite of tools for application development and integration developed and marketed by EPM
<b>EXPRESS Engine</b>	Express Compiler developed by NIST & NASA (Formerly EXPRESSO)
<b>FBMach</b>	A feature-based machining system developed by Honeywell Federal Manufacturing and Technologies (formerly Allied Signal)
<b>FeatureCAM</b>	A CAM System developed and marketed by Delcam USA
<b>FEDEX</b>	An (earlier) Express Compiler developed at NIST
<b>FORAN</b>	A CAD System for Ship Structural Design developed and marketed by SENER
<b>FREEDOM</b>	A 3D ECAD System developed and marketed by Zukan-Redac
<b>GibbsCAM</b>	A CAM System developed and marketed by Gibbs and Associates
<b>ICAD</b>	A knowledge-based engine marketed by KTI
<b>I-DEAS</b>	A CAD system developed and marketed by SDRC
<b>InterData Access (IDA)</b>	A company, now, within Spatial Technology, Inc. - Provides data analysis tools and services
<b>Intergraph</b>	A company that develops and markets CAD/CAM systems
<b>IronCAD</b>	A CAD System developed and marketed by ICAD
<b>ISDP/GSCAD</b>	A Shipbuilding CAD/CAM System developed and marketed by Intergraph
<b>ITI</b>	International TechneGroupe, Inc. - A Product Data Interoperability Tool developer and vendor
<b>Kockcums Computer Systems (KCS)</b>	A European company that develops and markets CAD/CAM Systems (e.g., Tribon)
<b>KTI</b>	Knowledge Technologies International
<b>LOCAM</b>	A CAM system developed and marketed by LSC Group, Ltd
<b>LKSoft</b>	A German Company that develops and markets CAD/CAM/CAE Software Tools
<b>MasterCAM</b>	A CAM System developed and marketed by CNC Software, Inc.
<b>Mechanical Desktop</b>	A CAD/CAM system developed and marketed by Autodesk

<b>Product/Vendor</b>	<b>Description</b>
<b>Mentorgraphics</b>	An Electrical/Electronic CAE System Vendor
<b>Parasolid</b>	Geometric Modeling Kernel supporting 3D surfaces and BREP solids
<b>PDGS</b>	Product Design Graphics System - A CAD System developed by Ford Motor Corporation
<b>PD Tec</b>	A German Product Data Modeling Software Company
<b>PLM</b>	A Product Line of EDS/UGSolutions
<b>Pro/ENGINEER (Pro/E)</b>	A CAD System developed and marketed by PTC
<b>PTC</b>	Parametric Technology Corporation
<b>SDRC</b>	Structural Dynamics Research Corporation
<b>SENER Ingenieria Sistemas, S.A.</b>	A European Company that develops and markets CAD/CAM systems
<b>SIMSMART</b>	A process engineering simulation tool. Also the name of the Canadian company that develops and markets the tool.
<b>Solid Edge</b>	A PC-based CAD system marketed by Unigraphics Solutions
<b>SolidWorks</b>	A PC-based CAD System marketed by Dassault Systemes (Developed by SolidWorks Corporation, now a subsidiary of Dassault)
<b>SmartCAM</b>	A CAM system developed and marketed by SDRC
<b>Spatial Technology, Inc.</b>	Develops and markets ACIS and ACIS based tools
<b>STEP Tools, Inc.</b>	Provides STEP related tools, translators, and services
<b>SurfCAM</b>	A CAM system developed and marketed by SDRC
<b>Theorem Solutions</b>	A Product Data Exchange Software Tool Company in the UK
<b>Tribon</b>	A CAD System for Ship Structural Design developed and marketed by Kockums Computer Systems (KCS)
<b>Unigraphics</b>	a CAD system developed and marketed by UGSolutions
<b>Unigraphics Solutions (UGSolutions)</b>	Develops and markets Unigraphics, Solid Edge, Bravo, and Parasolid
<b>Zuken Redac</b>	An Electrical/Electronic CAE System Vendor

# 1 Introduction

The Standard for the Exchange of Product model data (STEP - ISO 10303) provides a neutral computer-interpretable representation of product data throughout the life cycle of a product, independent of any particular system. STEP is actually a suite of international standards built around an integrated architecture of domain specific application protocols (AP) and generic integrated resources. The AP's break STEP into manageable and comprehensible "chunks" that can be more readily implemented.

Almost everyone involved with product design and/or manufacture, whether it is mechanical, electrical/electronic, or electromechanical, agrees on the importance of being able to exchange product data effectively among contractors/customers and subcontractors/suppliers who often use different CAD/CAM/CAE systems. Manufacturing is frequently outsourced. Accurate, complete product data is essential for the production and procurement of quality products. The issue of "standards" usually comes up in discussions about data exchange.

In this handbook, we will present a brief introduction to STEP along with an indication of how the ISO Standardization Process works relative to STEP. The current status of STEP development will be presented with emphasis on those parts of STEP that have achieved International Standard (IS) status and those parts that will soon reach that status. The scopes of these STEP Application Protocols (AP's) are presented to indicate what is and isn't addressed in the AP's. This information is presented so that the engineering user is able to see the depth of coverage of the AP's and to identify those STEP AP's and their associated conformance classes that best will meet the user's product data exchange (PDE) requirements.

The handbook is intended as a collection of information on the current state of STEP and it's current usability. It is intended to provide information of value to engineering users with a need to exchange product data with customers and/or suppliers.

It identifies the application domains being covered by STEP development and the tools that are commercially available for using STEP. It provides some guidance on using the STEP technology that is currently available and cites sources of additional information.



## 2 Background

### 2.1 ISO 10303 (STEP) Overview

(from "STEP, A Key Tool in the Global Market", UK Council for Electronic Business (UKCEB))

"STEP, Standard for the Exchange of Product Model Data, provides a representation of product information along with the necessary mechanisms and definitions to enable product data to be exchanged. The exchange is among different computer systems and environments associated with the complete product lifecycle including design, manufacture, utilisation, maintenance, and disposal. The information generated about a product during these processes is used for many purposes. This use may involve many computer systems, including some that may be located in different organisations. In order to support such uses, organisations must be able to represent their product information in a common computer-interpretable form that is required to remain complete and consistent when exchanged among different computer systems.

STEP is organised as a series of parts, each published separately. These parts fall into one of the following series: description methods, integrated resources, application protocols, abstract test suites, implementation methods, and conformance testing. STEP uses a formal specification language, EXPRESS, to specify the product information to be represented. The use of a formal language enables precision and consistency of representation and facilitates development of implementations. STEP uses application protocols (APs) to specify the representation of product information for one or more applications. It is expected that several hundred APs may be developed to support the many industrial applications that STEP is expected to serve.

An addition to the STEP standard that certainly will enhance its implementability and acceptance is the constraint that abstract test suites and conformance testing must be built into the standard.

The overall objective of STEP is to provide a mechanism that is capable of describing product data throughout the life cycle of a product, independent from any particular system. The nature of this description makes it suitable not only for neutral file exchange, but also as a basis for implementing and sharing product databases and archiving. The ultimate goal is an integrated product information database that is accessible and useful to all the resources necessary to support a product over its lifecycle."

For more information on STEP, the reader is referred to some of the following introductory texts on STEP:

1. Introducing STEP - The Foundation for Product Data Exchange in the Aerospace and Defence Sectors, National Research Council Canada, C2-447/1999, Susan Gilles (ed), 1999.
2. STEP-The Grand Experience, NIST, Sharon J. Kemmerer (ed.), July 1999
3. STEP:Towards Open Systems-STEP Fundamentals and Business Benefits, Dr. Kais Al-Timimi & John MacKrell, CIMdata, September, 1996.

Several Websites to visit for Introductory/Background Information on STEP are the following:

1. Team SCRA - RAMP Product Data --- [http://ramp.isg-scra.org/pdt\\_summary.html](http://ramp.isg-scra.org/pdt_summary.html)
2. PDES Inc. Public Website --- <http://pdesinc.aticorp.org/>
3. PDES, Inc. STEP Overview --- [http://pdesinc.aticorp.org/step\\_overview.html](http://pdesinc.aticorp.org/step_overview.html)
4. NIST SC4 Website (Updated 2001-11-28): --- <http://www.nist.gov/sc5/soap/> STEP On A Page

5. UK Council for Electronic Business (UKCEB) Website --- <http://www.ukceb.org/> "STEP-A Key Tool in the Global Market" (Overview) --- Nice History of STEP
6. ProSTEP --- <http://www.prostep.org/en/services/> (In German)
7. Canadian Handbook: Introducing STEP --- [http://imti-itfi.nrc-cnrc.gc.ca/publns\\_f.html](http://imti-itfi.nrc-cnrc.gc.ca/publns_f.html)

A very useful compact summary of the STEP development process with a periodic status update was developed by Jim Nell (@ NIST). Jim is the chairman of ISO TC184/SC5, but was a long time participant in the working groups of ISO TC184/SC4 (the "home" of STEP). Jim conceived the concept of "STEP On A Page" (SOAP). On the front and back of a single "piece of paper", he was able to capture a description of all of the STEP documents and a summary of their development status which he continues to maintain/update on a periodic basis. SOAP appears below. SOAP can be found @ <http://www.nist.gov/sc5/soap/> (See APPENDIX C – STEP On A Page).

PDES, Inc. also created a set of easy to understand graphics that describe the STEP Application Protocols which can be referred to as "User Friendly AP's on a Page". They can be found at the PDES, Inc. Public Web Site @ [http://pdesinc.aticorp.org/aps\\_modules.html](http://pdesinc.aticorp.org/aps_modules.html)

Over the years, the International STEP community has worked very closely within the ISO TC184/SC4 working groups with international meetings occurring 3 or 4 times a year. Within most of the countries, national STEP Centers have been established. Often, as important issues would arise or affirmation of commitments was felt to be appropriate, Memoranda of Understanding (MOU's) would be signed and issued as "Press Releases". Several of the more important MOU's were the MOU's signed (in the mid 1990's) by the international aerospace companies and automotive companies committing to the support of STEP development and implementation. Some of the more recent MOU's were: (see <http://pdesinc.aticorp.org/> & its archives)

- the 1997 MOU on the harmonized STEP PDM Schema (viz., for AP's 203, 210, 212, 214, & 232) signed by ProSTEP, PDES, Inc., and JSTEP,
- the 1998 MOU on the use of the STEP PDM Schema for the EuroFighter signed by BAe (UK), DASA (Germany), CASA (Spain), and Alenia (Italy),
- the 1999 MOU on Modular Development and Implementation sign by PDES, Inc., ProSTEP, GOSET, and JSTEP, and
- the 1999 MOU on Conformance Testing and Certification signed by PDES, Inc., GOSET, JSTEP, and C-STEP.
- the 1999 Memorandum of Understanding (MOU) between NAFEMS and PDES, Inc.,
- the 1999 MOU between PDES, Inc. and ProSTEP to define a Joint Work Plan for developing, testing, and implementing STEP capability.
- the 1999 agreement between PDES, Inc. and ProSTEP on version 1.1 of the Unified PDM Schema.
- the 1999 terms of reference for International STEP Centers (ISC) signed by PDES, Inc., ProSTEP, GOSET, JSTEP, AUSDEC, SWEDSTEP, and UNINOVA.

## 2.2 Existing/Active STEP Application Protocols

The following list includes STEP Application Protocols that are active.

**Table 3 — STEP Application Protocols**

<b>AP</b>	<b>Publishing date</b>	<b>Ballot stage</b>	<b>Title</b>
AP201	1994	IS	Explicit draughting
AP202	1997	IS	Associative draughting
AP203	1994	IS	Configuration controlled 3D designs of mechanical parts and assemblies
	1998	TC	
	2000	TC	
	2004	TS	
AP204	2002	IS	Mechanical design using boundary representation
AP207	1999	IS	Sheet metal die planning and design
	2001	TC	
AP209	2001	IS	Composite and metallic structural analysis & related design
AP210	2001	IS	Electronic assembly, interconnection and exchange
AP210 2 <sup>ND</sup>		DIS	
AP212	2001	IS	Electrotechnical design and installation
Ap214	2001	IS	Core data for automotive mechanical design processes
AP214 2 <sup>ND</sup>	2004	IS	
AP215	2003	IS	Ship arrangement
AP216	2004	IS	Ship moulded forms
AP218	2004	IS	Ship structures
AP219	2006	DIS	Manage dimensional inspection of solid parts or assemblies
AP221	2006	DIS	Functional data and their schematic representation for process plants
AP223	2006	CD	Exchange of design and manufacturing product information for cast parts
AP224	1999	IS	Mechanical product definition for process planning using machining features
AP224 2 <sup>ND</sup>	2001	IS	
AP224 3 <sup>RD</sup>	2006	IS	
AP225	1999	IS	Building elements using explicit shape representation
AP227	2001	IS	Plant spatial configuration
AP227 2 <sup>ND</sup>	2005	IS	
AP229	2006	NWI	Design and manufacturing product information for forged parts
AP232	2002	IS	Technical data packaging core information and exchange
AP233	2005	AWI	Systems engineering data representation
AP235	2005	CD	Materials information for the design and verification of products
AP236	2005	DIS	Furniture product data and project data

<b>AP</b>	<b>Publishing date</b>	<b>Ballot stage</b>	<b>Title</b>
AP238	2006	DIS	Application interpreted model for computerized numeric controllers
AP239	2005	IS	Product Life Cycle Support
AP240	2005	IS	Numerical control process plans for machined parts

**Where**

<b>PWI</b>	<b>Preliminary Work Item</b>	<b>TC</b>	<b>Technical Corrigendum</b>
<b>NWI</b>	<b>New Work Item</b>	<b>TS</b>	<b>Technical Specification</b>
<b>AWI</b>	<b>Approved Work Item</b>		
<b>WD</b>	<b>Working Draft</b>		
<b>CD</b>	<b>Committee Draft</b>		
<b>DIS</b>	<b>Draft International Standard</b>		
<b>IS</b>	<b>International Standard</b>		

See the PDES, Inc. public web site: [http://pdesinc.aticorp.org/whatsnew/all\\_aps.html](http://pdesinc.aticorp.org/whatsnew/all_aps.html) for "user friendly" graphics describing most of the STEP AP's individually "on a page".

PDES, Inc., along with other STEP organizations worldwide, has put forth an initiative to develop STEP Application Modules (AM's) that are domain, or even complete AP, building blocks. The initial set of AM's (1001-1009) have been published as ISO Technical Specifications (TS) in 2001. This effort is aimed at significantly speeding up the ISO standardization process. The AM initiative has widespread support, particularly from the user community. The next set of 64 AM's started the four (4) month CD/TS ballot cycle on 2001-10-17. These are the Product Data Management (PDM) Application Modules, and are being balloted as eight (8) packages of AM's.

AP203 (Edition 2) will be developed using AM's and is expected to be balloted in 2006 as a Technical Specification. It will include the PDM AM's (replacing the current Configuration Management (CM) conformance classes (cc1a & 1b)), colors and layers, validation properties, and the construction history and dimensions and tolerance modules which are under development and will be balloted as AM's in 2002. The Engineering Analysis Core Model (EACM) and AP233 (Systems Engineering) have also committed to a modular approach.

The following table identifies the stages in the ISO Standardization Process. The process of reaching international consensus on a standard can be and often is very arduous. STEP Application Protocol development, from the initial proposal for a new project (the Preliminary Work Item) to the publication of the International Standard, often has taken five (5) or more years to complete.

## 2.3 International Harmonized Stage Codes

**Table 4 — ISO Stage Codes**

STAGE	SUBSTAGE						
	00	20	60	90	Decision	99	
	Registration	Start of Main Action	Completion of Main Action	92 Repeat of Earlier Phase	93 Repeat Current Phase	98 Abandon	99 Proceed
<b>00 Preliminary Stage</b>	00.00 Proposal for new project received	00.20 Proposal for new project under review	00.60 Review summary circulated			00.98 Proposal for new project abandoned	00.99 Approval to ballot proposal for new project
<b>10 Proposal Stage</b>	10.00 Proposal for new project registered	10.20 New Project ballot initiated <i>4 months</i>	10.60 Voting summary circulated	10.92 Proposal returned to submitter for further definition		10.98 New project rejected	10.99 New project approved
<b>20 Preparatory Stage</b>	20.00 New project registered in TC/SC work program	20.20 Working Draft (WD) study initiated	20.60 Comments summary circulated			20.98 Project deleted	20.99 WD approved for registration as CD
<b>30 Committee Stage</b>	30.00 Committee Draft (CD) registered	30.20 CD study/ballot initiated <i>4 months-1<sup>st</sup></i> <i>3 months-2<sup>nd</sup>+</i>	30.60 Comments/ voting summary circulated	30.92 CD referred back to working group		30.98 Project deleted	30.99 CD approved for registration as DIS
<b>40 Enquiry Stage</b>	40.00 DIS registered	40.20 DIS ballot initiated <i>5 months</i>	40.60 Voting summary dispatched	40.92 Full report circulated: DIS referred back to TC or SC	40.93 Full report circulated: decision for new DIS ballot	40.98 Project deleted	40.99 Full report circulated: DIS approved for registration as FDIS
<b>50 Approval Stage</b>	50.00 FDIS registered for formal approval	50.20 FDIS ballot initiated: <i>2 months</i> . Proof sent to secretariat	50.60 Voting summary dispatched. Proof returned by secretariat	50.92 FDIS referred back to TC or SC		50.98 Project deleted	50.99 FDIS approved for publication
<b>60 Publication Stage</b>	60.00 International Standard under publication		60.60 International Standard published				
<b>90 Review Stage</b>		90.20 International Standard under periodical review	90.60 Review summary dispatched	90.92 International Standard to be revised	90.93 International Standard confirmed		90.99 Withdrawal of International Standard proposed by TC or SC
<b>95 Withdrawal Stage</b>		95.20 Withdrawal ballot initiated	95.60 Voting summary dispatched	95.92 Decision not to withdraw International Standard			95.99 Withdrawal of International Standard

### 2.3.1 Examples of the principal abbreviations used in the technical program

The following table gives examples of the principal abbreviations used in the ISO technical program, together with an indication of the corresponding project stage.

**Table 5 — ISO Stage Abbreviations**

Stage	Abbreviation	Description	
<b>20</b> <b>Preparatory stage</b>	20.00	AWI AWI Amd AWI TR or TS	Approved Work Item, no working draft yet available. Approved proposal for an Amendment Approved proposal for a Technical Report or a Technical Specification
	20.20	WD WD Amd WD TR or TS	Working Draft Working draft of an Amendment Working draft of a Technical Report or a Technical Specification
<b>30</b> <b>Committee stage</b>		CD CD Amd CD Cor CD TR or TS	Committee Draft Committee draft of an Amendment Committee draft of a Technical Corrigendum Committee draft of a Technical Report or a Technical Specification
		DTR <i>PDAm</i>	Draft Technical Report <i>Proposed draft amendment</i>
<b>40</b> <b>Enquiry stage</b>		DIS DAmd <i>FCD</i> <i>FPDISP</i>	Draft International Standard Draft Amendment <i>Final Committee draft</i> <i>Final proposed Draft International Standardized Profile</i>
<b>50</b> <b>Approval stage</b>		FDIS FDAm	Final Draft International Standard Final draft amendment
		PRF PRF Amd PRF TR or TS PRF Suppl	Proof of a new International Standard Proof of an Amendment Proof of a Technical Report or a Technical Specification Proof of a Supplement
<b>60</b> <b>Publication stage</b>		ISO ISO/TR or TS Amd Cor	International Standard Technical Report or Technical Specification Amendment Technical Corrigendum

#### NOTES RELATING TO THE ABOVE TABLE

- The abbreviations in italics apply only to the projects of ISO/IEC JTC 1.
- The abbreviations **AWI** (approved work item) and **PRF** (proof) do not appear in the *ISO/IEC Directives, Part 1: Procedures for the technical work, 1995*, but have been added here to reflect the current options. AWI is only used for stage 20.00 (new project registered in TC/SC work program) and PRF is applied in cases where projects are passing through the approval stage (50) without being subject to a FDIS ballot.

## **2.4 Comments on STEP AP's, AIC's, AM's and RPG's**

STEP development is reaching a point at which numerous STEP Standards are reaching closure and stability. There are now Twenty Two (22) Application Protocols that have achieved IS status. It would seem that this is an opportune point in time for CAD/CAM Vendors to expand their implementation coverage.

There are conformance classes (cc) associated with each AP. Conformance classes are subsets of an AP that can be implemented "meaningfully" within that application domain without having to implement all aspects of the AP. Implementation of selected conformance classes can be seen in those AP's that have been commercially implemented to date (viz., AP's 203 and 214).

As an engineering user, it will be important to know what conformance classes of an AP have been implemented. It is not enough to indicate that a Vendor has a STEP or an APxxx translator. The engineering user will need to know what conformance classes of APxxx have been implemented and to understand the coverage of those conformance classes. As examples: AP203 has 12 conformance classes (1a,b through 6a,b). Very few Vendors who claim to have an AP203 translator have implemented cc 5; most have implemented cc's 2a, 4a & 6a (i.e., with a "minimal" (but acceptable, by consensus) subset of Configuration Management data (viz., cc1a)). Vendors who claim to have an AP214 translator have only implemented cc1 and/or cc2 that are essentially identical to AP203 geometry/topology with a somewhat different set of configuration management data. Note that AP214 has 20 conformance classes; these 20 conformance classes cover essentially the entire spectrum of automotive design. It is misleading, at this point, for Vendors to claim that they have implemented AP214 without qualifying that statement with the conformance classes that have been implemented. There are currently no commercially available AP214 translators that address other than the AP203 "look alike" conformance classes (i.e., AP214 cc's 1 & 2). It should be noted that some of the Vendors now have prototype implementations of the PDM conformance classes (cc 6 & 7) of AP214. Extensive effort has been expended in harmonizing the PDM Schema with those STEP AP's addressing PDM data such as AP's 203, 209, 214, and 232.

In the following sections, the scope is given for each of the AP's that have been published as ISO 10303 standards, those that are considered "soon to be IS", and those that are still in the process of being developed. The conformance classes associated with each of the AP's that have achieved IS status are also provided, as well as many of those that are still in development. The intention here is to provide the engineering user with a view of the robustness of the STEP AP's and the potential usefulness of implementations of the associated conformance classes. As will be noted later, in the final analysis, it will be the engineering user who will drive the Vendor implementations of STEP AP conformance classes.

### **2.4.1 Application Interpreted Construct**

A concept that was created within the STEP development process was that of the Application Interpreted Construct (AIC) which could be referenced by multiple AP's and, thereby, reduce the number of pages in AP documents and assure consistency among the AP's referencing the AIC's.

Almost all of the current STEP AIC's (i.e., 501 - 515, 517, 519, 520) have achieved International Standard (IS) status. AIC518 is currently at Draft International Standard (DIS) status, and AIC516 was cancelled. AIC521 is new and its five (5) month DIS Ballot began In December 2001.

The AIC's are reiterated below for reference

**Table 6 — Application Interpreted Construct**

<b>Application Interpreted Construct</b>	<b>Description</b>
10303-501:2000	Edge-based wireframe
10303-502:2000	Shell-based wireframe
10303-503:2000	Geometrically Bounded 2D wireframe
10303-504:2000	Draughting annotation
10303-505:2000	Drawing structure and administration
10303-506:2000	Draughting elements
10303-507:2001	Geometrically bounded surface
10303-508:2001	Non-manifold surface
10303-509:2001	Manifold surface
10303-510:2000	Geometrically bounded wireframe
10303-511:2001	Topologically bounded surface
10303-512:1999	Faceted boundary representation
10303-513:2000	Elementary boundary representation
10303-514:1999	Advanced boundary representation
10303-515:2000	Constructive solid geometry
10303-517:2000	Mechanical design geometric presentation
10303-518/DIS	Mechanical design shaded presentation
10303-519:2000	Geometric tolerances
10303-520:1999	Associative draughting elements
10303-521:2003	Manifold subsurface
10303-522:2006	Machining features
10303-523:2004	Curve swept solid

## 2.4.2 Application Module

Application modules are the key component of the modularization of the initial ISO 10303 architecture. The modular approach extends the application interpreted construct (AIC) concept of the initial ISO 10303 architecture through inclusion of the relevant portions of the AP's application reference model. The basis of the approach is understanding and harmonizing the requirements, both new and those documented in existing APs, grouping the requirements into reusable modules, documenting the modules, and using the modules in the development of an application protocol.

An AM contains much of the technical content that, in the initial ISO 10303 architecture, was documented in an AP. The role of an AP document in the new architecture is to provide a business context for the industrial use and implementation of the application modules that are the data specification of the AP.

There are three types of application modules: foundation modules (level 1), implementation modules (level 2), and AP modules. Foundation modules provide lower level reusable structures that are not likely to be implemented alone, but are highly shareable and reusable. Implementation modules define a capability that can be implemented and against which conformance classes may be defined. Each AP references a single root module that is an AP module. An AP module is an implementation module, and the contents of an AP module are the same as other implementation modules, the only documentation difference is in their name and title. The AP module from one AP may be used by another AP. Detailed



descriptions of the different application modules are provided in *Guidelines for the content of application modules*.

The development of the ISO 10303 modular architecture was driven by the following requirements:

- to reduce the high cost of developing an application protocol;
- to ensure the ability to implement a combination of subsets of multiple APs or to extend existing APs to meet a business need;
- to ensure the ability to reuse application software developed to support one AP in the development of an implementation of another AP with the same, or similar, requirements;
- to avoid the duplication and repeated documentation of the same requirements in different application protocols leading to potentially different solutions for the same requirements; and
- to ensure the ability to reuse data generated by an implementation of one or more APs by an implementation of one or more different APs.

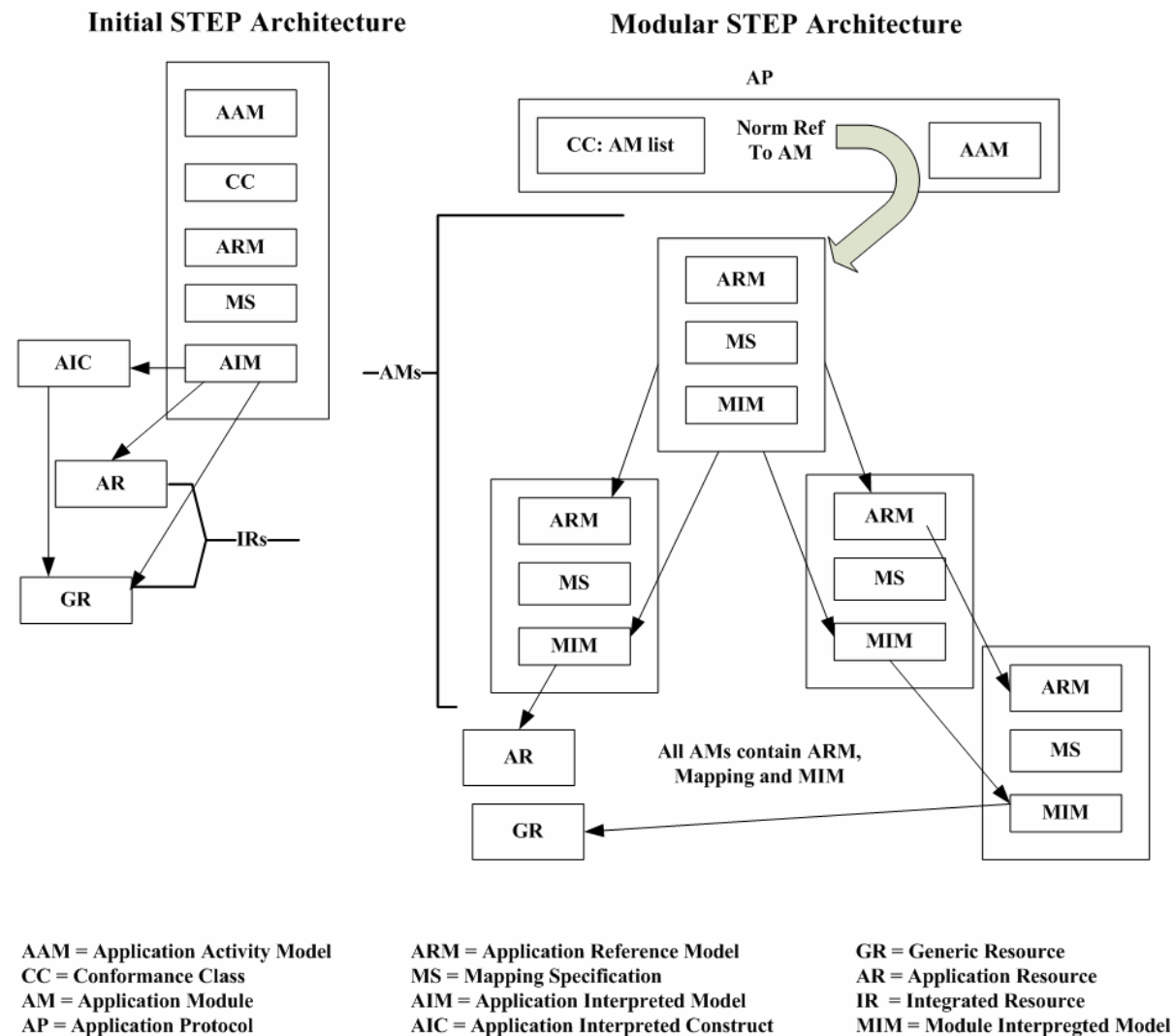

**Figure 1— Contrasting the AP architectures**

The expected audience for this document includes developers of ISO 10303 application modules and application protocols as well as users of application protocols who are interested in a more in-depth understanding of the origins of the structure of application protocols.

Figure 1 contrasts the architecture of an application protocol that uses application modules with the initial application protocol architecture. (See APPENDIX C – STEP On A Page).

The currently planned Module Suites include:

**Table 7 — Application Modules**

<b>Application Module</b>	<b>Description</b>
ISO/TS 1001	Appearance assignment
ISO/TS 1002	Colour
ISO/TS 1003	Curve appearance
ISO/TS 1004	Elemental shape
ISO/TS 1005	Elemental topological shape
ISO/TS 1006	Foundation representation
ISO/TS 1007	General surface appearance
ISO/TS 1008	Layer assignment
ISO/TS 1009	Shape appearance and layers
ISO/TS 1010	Date time
ISO/TS 1011	Person organization
ISO/TS 1012	Approval
ISO/TS 1013	Person organization assignment
ISO/TS 1014	Date time assignment
ISO/TS 1015	Security classification
ISO/TS 1016	Product categorization
ISO/TS 1017	Product identification
ISO/TS 1018	Product version
ISO/TS 1019	Product view definition
ISO/TS 1020	Product version relationship
ISO/TS 1021	Identification assignment
ISO/TS 1022	Part and version identification
ISO/TS 1023	Part view definition
ISO/TS 1024	Product relationship
ISO/TS 1025	Alias identification
ISO/TS 1026	Assembly structure
ISO/TS 1027	Contextual shape positioning
ISO/TS 1030	Property assignment
ISO/TS 1032	Shape property assignment
ISO/TS 1033	External model
ISO/TS 1034	Product view definition properties
ISO/TS 1036	Independent property
ISO/TS 1038	Independent property representation
ISO/TS 1039	Geometric validation property representation
ISO/TS 1040	Process property assignment
ISO/TS 1041	Product view definition relationship
ISO/TS 1042	Work request

<b>Application Module</b>	<b>Description</b>
ISO/TS 1043	Work order
ISO/TS 1044	Certification
ISO/TS 1046	Product replacement
ISO/TS 1047	Activity
ISO/TS 1049	Activity method
ISO/TS 1050	Dimension tolerance
ISO/TS 1051	Geometric tolerance
ISO/TS 1052	Default tolerance
ISO/TS 1054	Value with unit
ISO/TS 1055	Part definition relationship
ISO/TS 1056	Configuration item
ISO/TS 1057	Effectivity
ISO/TS 1058	Configuration effectivity
ISO/TS 1059	Effectivity application
ISO/TS 1060	Product concept identification
ISO/TS 1061	Project
ISO/TS 1062	Contract
ISO/TS 1063	Product occurrence
ISO/TS 1064	Event
ISO/TS 1065	Time Interval
ISO/TS 1068	Constructive solid geometry 3d
ISO/TS 1070	Class
ISO/TS 1071	Class of activity
ISO/TS 1074	Property condition
ISO/TS 1077	Class of product
ISO/TS 1080	Property space
ISO/TS 1085	Property identification
ISO/TS 1091	Maths space
ISO/TS 1092	Maths value
ISO/TS 1099	Independent property definition
ISO/TS 1101	Product property feature definition
ISO/TS 1102	Assembly feature definition
ISO/TS 1103	Product class
ISO/TS 1104	Specified product
ISO/TS 1105	Multi linguism
ISO/TS 1106	Extended measure representation
ISO/TS 1108	Specification based configuration
ISO/TS 1109	Alternative solution
ISO/TS 1110	Surface conditions
ISO/TS 1111	Classification with attributes
ISO/TS 1112	Specification control
ISO/TS 1113	Group
ISO/TS 1114	Classification assignment
ISO/TS 1115	Part collection
ISO/TS 1116	Pdm material aspects
ISO/TS 1118	Measure representation
ISO/TS 1121	Document and version identification

<b>Application Module</b>	<b>Description</b>
ISO/TS 1122	Document assignment
ISO/TS 1123	Document definition
ISO/TS 1124	Document structure
ISO/TS 1126	Document properties
ISO/TS 1127	File identification
ISO/TS 1128	External item identification assignment
ISO/TS 1129	External properties
ISO/TS 1130	Derived shape element
ISO/TS 1131	Construction geometry
ISO/TS 1132	Associative text
ISO/TS 1133	Single part representation
ISO/TS 1134	Product structure
ISO/TS 1136	Text appearance
ISO/TS 1140	Requirement identification and version
ISO/TS 1141	Requirement view definition
ISO/TS 1142	Requirement view definition relationship
ISO/TS 1143	Building component
ISO/TS 1144	Building item
ISO/TS 1145	Building structure
ISO/TS 1146	Location in building
ISO/TS 1147	Manufacturing configuration effectively
ISO/TS 1151	Functional data
ISO/TS 1156	Product structure and classification
ISO/TS 1157	Class of product structure
ISO/TS 1158	Class of composition of product
ISO/TS 1159	Class of connection of product
ISO/TS 1160	Class of containment of product
ISO/TS 1161	Class of involvement of product in connection
ISO/TS 1162	Class of product library
ISO/TS 1163	Individual product structure
ISO/TS 1164	Product as individual
ISO/TS 1165	Involvement of individual product in connection
ISO/TS 1166	Composition of individual product
ISO/TS 1167	Connection of individual product
ISO/TS 1168	Containment of individual product
ISO/TS 1169	Activity structure and classification
ISO/TS 1170	Class of activity structure
ISO/TS 1171	Class of composition of activity
ISO/TS 1172	Class of connection of activity
ISO/TS 1173	Class of involvement in activity
ISO/TS 1174	Class of activity library
ISO/TS 1175	Individual activity structure
ISO/TS 1176	Individual activity
ISO/TS 1177	Composition of individual activity
ISO/TS 1178	Connection of individual activity
ISO/TS 1179	Individual involvement in activity
ISO/TS 1188	Class of person

<b>Application Module</b>	<b>Description</b>
ISO/TS 1198	Property and property assignment
ISO/TS 1199	Possession of property
ISO/TS 1203	Schematic and symbolization
ISO/TS 1204	Schematic drawing
ISO/TS 1205	Schematic element
ISO/TS 1206	Draughting annotation
ISO/TS 1207	Drawing structure and administration
ISO/TS 1208	Schematic element library
ISO/TS 1209	Symbolization by schematic element
ISO/TS 1210	Set theory
ISO/TS 1211	Cardinality of relationship
ISO/TS 1212	Classification
ISO/TS 1213	Reference data library
ISO/TS 1214	System breakdown
ISO/TS 1215	Physical breakdown
ISO/TS 1216	Functional breakdown
ISO/TS 1217	Zonal breakdown
ISO/TS 1218	Hybrid breakdown
ISO/TS 1228	Representation with uncertainty
ISO/TS 1233	Requirement assignment
ISO/TS 1240	Organization type
ISO/TS 1241	Information rights
ISO/TS 1242	Position in organization
ISO/TS 1243	Experience
ISO/TS 1244	Qualifications
ISO/TS 1245	Type of person
ISO/TS 1246	Attribute classification
ISO/TS 1248	Product breakdown
ISO/TS 1249	Activity method assignment
ISO/TS 1250	Attachment slot
ISO/TS 1251	Interface
ISO/TS 1252	Probability
ISO/TS 1253	Condition
ISO/TS 1254	Condition evaluation
ISO/TS 1255	State definition
ISO/TS 1256	State observed
ISO/TS 1257	Condition characterized
ISO/TS 1258	Observation
ISO/TS 1259	Activity as realized
ISO/TS 1260	Scheme
ISO/TS 1261	Activity method implementation
ISO/TS 1262	Task specification
ISO/TS 1263	Justification
ISO/TS 1265	Envelope
ISO/TS 1266	Resource management
ISO/TS 1267	Required resource
ISO/TS 1268	Resource item

<b>Application Module</b>	<b>Description</b>
ISO/TS 1269	Resource as realized
ISO/TS 1270	Message
ISO/TS 1271	State characterized
ISO/TS 1272	Activity characterized
ISO/TS 1273	Resource property assignment
ISO/TS 1274	Probability distribution
ISO/TS 1275	External class
ISO/TS 1276	Location
ISO/TS 1277	Location assignment
ISO/TS 1278	Product group
ISO/TS 1280	Required resource characterized
ISO/TS 1281	Resource item characterized
ISO/TS 1282	Resource management characterized
ISO/TS 1283	Resource as realized characterized
ISO/TS 1285	Work request characterized
ISO/TS 1286	Work order characterized
ISO/TS 1287	AP239 activity recording
ISO/TS 1288	Management resource information
ISO/TS 1289	AP239 management resource information
ISO/TS 1290	Document management
ISO/TS 1291	Plib class reference
ISO/TS 1292	AP239 product definition information
ISO/TS 1293	AP239 Part definition information
ISO/TS 1294	Interface lifecycle
ISO/TS 1295	AP239 properties
ISO/TS 1296	Condition evaluation characterized
ISO/TS 1297	AP239 document management
ISO/TS 1298	Activity method characterized
ISO/TS 1300	Work output
ISO/TS 1301	Work output characterized
ISO/TS 1304	AP239 product status recording
ISO/TS 1306	AP239 task specification resourced
ISO/TS 1307	AP239 work definition
ISO/TS 1340	Name assignment
ISO/TS 1341	Generic expression
ISO/TS 1342	Expression
ISO/TS 1343	Product placement
ISO/TS 1344	Numerical interface
ISO/TS 1345	Item definition structure
ISO/TS 1346	Numeric function
ISO/TS 1347	Wireframe 2d
ISO/TS 1348	Requirement management
ISO/TS 1349	Incomplete data reference mechanism
ISO/TS 1350	Inertia characteristics
ISO/TS 1351	Catalog data information
ISO/TS 1352	Catalog data information and shape representation
ISO/TS 1353	Parameterized catalog data information

<b>Application Module</b>	<b>Description</b>
ISO/TS 1354	Furniture interior decoration
ISO/TS 1355	Parameterized catalog data and shape representation
ISO/TS 1357	Selected item
ISO/TS 1358	Location assignment characterized
ISO/TS 1364	Event assignment
ISO/TS 1365	Time interval assignment
ISO/TS 1366	Encoded text representation
ISO/TS 1501	Edge based wireframe
ISO/TS 1502	Shell based wireframe
ISO/TS 1507	Geometrically bounded surface
ISO/TS 1509	Manifold surface
ISO/TS 1510	Geometrically bounded wireframe
ISO/TS 1511	Topologically bounded surface
ISO/TS 1512	Faceted boundary representation
ISO/TS 1514	Advanced boundary representation
ISO/TS 1601	Altered package
ISO/TS 1602	Altered Part
ISO/TS 1603	Analytical model
ISO/TS 1604	AP210 assembly functional interface requirements
ISO/TS 1605	AP210 assembly functional requirements
ISO/TS 1606	AP210 assembly physical design
ISO/TS 1607	AP210 assembly physical interface requirements
ISO/TS 1608	AP210 assembly physical requirements
ISO/TS 1609	AP210 assembly requirement allocation
ISO/TS 1610	AP210 assembly technology constraints
ISO/TS 1611	AP210 connection zone based model extraction
ISO/TS 1612	AP210 device functional and physical characterization
ISO/TS 1613	Physical unit non planar design view
ISO/TS 1614	AP210 functional decomposition
ISO/TS 1615	AP210 functional requirement allocation
ISO/TS 1616	AP210 functional specification
ISO/TS 1617	AP210 interconnect design
ISO/TS 1618	AP210 interconnect design for microwave
ISO/TS 1619	AP210 interconnect functional requirements
ISO/TS 1620	AP210 interconnect physical requirements
ISO/TS 1621	AP210 interconnect requirement allocation
ISO/TS 1622	AP210 interconnect technology constraints
ISO/TS 1623	AP210 laminate assembly design
ISO/TS 1624	AP210 package functional and physical characterization
ISO/TS 1625	AP210 packaged Part white box model
ISO/TS 1626	AP210 physical unit physical characterization
ISO/TS 1627	AP210 printed part functional and physical characterization
ISO/TS 1628	AP210 product data management
ISO/TS 1630	AP210 product rule
ISO/TS 1631	Area 2d
ISO/TS 1632	Assembly 2d shape
ISO/TS 1634	Assembly component placement requirements

<b>Application Module</b>	<b>Description</b>
ISO/TS 1635	Assembly functional interface requirement
ISO/TS 1636	Assembly module design
ISO/TS 1637	Assembly module macro definition
ISO/TS 1638	Assembly module with cable component 2d
ISO/TS 1639	Assembly module with cable component 3d
ISO/TS 1640	Assembly module with macro component
ISO/TS 1641	Assembly module with subassembly
ISO/TS 1642	Assembly module usage view
ISO/TS 1643	Assembly module with interconnect component
ISO/TS 1644	Assembly module with cable component
ISO/TS 1645	Assembly module with packaged connector component
ISO/TS 1646	Assembly shape
ISO/TS 1647	Assembly physical interface requirement
ISO/TS 1648	Assembly physical requirement allocation
ISO/TS 1649	Assembly technology
ISO/TS 1650	Bare die
ISO/TS 1651	Basic curve
ISO/TS 1652	Basic geometry
ISO/TS 1653	Cable
ISO/TS 1654	Characteristic
ISO/TS 1655	Chemical substance
ISO/TS 1656	Component grouping
ISO/TS 1657	Component feature
ISO/TS 1658	Connectivity allocation to physical network
ISO/TS 1659	Curve swept solid
ISO/TS 1660	Datum difference based mode
ISO/TS 1661	Design management
ISO/TS 1662	Design specific assignment to assembly usage view
ISO/TS 1663	Design specific assignment to interconnect usage view
ISO/TS 1664	Device marking
ISO/TS 1665	Electrical network definition
ISO/TS 1666	Extended geometric tolerance
ISO/TS 1667	Extended elemental geometric shape
ISO/TS 1668	Fabrication joint
ISO/TS 1669	Fabrication requirement
ISO/TS 1670	Fabrication technology
ISO/TS 1671	Feature and connection zone
ISO/TS 1672	Fill area style
ISO/TS 1673	Edge shape feature
ISO/TS 1674	Functional assignment to Part
ISO/TS 1675	Functional decomposition to assembly design
ISO/TS 1676	Functional decomposition to design
ISO/TS 1677	Functional decomposition to interconnect design
ISO/TS 1678	Functional decomposition with nodal representation to packaged mapping
ISO/TS 1679	Functional specification
ISO/TS 1680	Functional unit requirement allocation
ISO/TS 1681	Generic material aspects



<b>Application Module</b>	<b>Description</b>
ISO/TS 1682	Interconnect 2d shape
ISO/TS 1683	Interconnect 3d shape
ISO/TS 1684	Interconnect module connection routing
ISO/TS 1685	Interconnect module to assembly module relationship
ISO/TS 1686	Interconnect module usage view
ISO/TS 1687	Interconnect module with macros
ISO/TS 1688	Interconnect non planar shape
ISO/TS 1689	Interconnect physical requirement allocation
ISO/TS 1690	Interconnect placement requirements
ISO/TS 1691	Interface component
ISO/TS 1692	Land
ISO/TS 1693	Layered 2d shape
ISO/TS 1694	Layered 3d shape
ISO/TS 1695	Layered interconnect module 2d design
ISO/TS 1696	Layered interconnect module 3d design
ISO/TS 1697	Layered interconnect module 3d shape
ISO/TS 1698	Layered interconnect module design
ISO/TS 1699	Layered interconnect module design with design intent modifications
ISO/TS 1700	Layered interconnect module with printed component design
ISO/TS 1701	Layout macro definition
ISO/TS 1702	Manifold subsurface
ISO/TS 1703	Model parameter
ISO/TS 1704	Network functional design view
ISO/TS 1705	Network functional usage view
ISO/TS 1706	Non feature shape element
ISO/TS 1707	Package
ISO/TS 1708	Packaged connector model
ISO/TS 1709	Packaged Part white box model
ISO/TS 1710	Packaged part black box model
ISO/TS 1711	Part external reference
ISO/TS 1712	Part feature function
ISO/TS 1713	Part feature grouping
ISO/TS 1714	Part feature location
ISO/TS 1715	Part occurrence
ISO/TS 1716	Part template 2d shape
ISO/TS 1717	Part template 3d shape
ISO/TS 1718	Part template extension
ISO/TS 1719	Part template non planar shape
ISO/TS 1720	Part template shape with parameters
ISO/TS 1721	Physical component feature
ISO/TS 1722	Physical layout template
ISO/TS 1723	Physical node requirement to implementing component allocation
ISO/TS 1724	Physical unit 2d design view
ISO/TS 1725	Physical unit 3d design view
ISO/TS 1726	Physical unit 2d shape
ISO/TS 1727	Physical unit 3d shape
ISO/TS 1728	Physical unit design view

<b>Application Module</b>	<b>Description</b>
ISO/TS 1729	Physical unit interconnect definition
ISO/TS 1730	Physical unit shape with parameters
ISO/TS 1731	Application module:Constructive solid geometry 2d
ISO/TS 1732	Physical unit usage view
ISO/TS 1733	Planned characteristic
ISO/TS 1734	Pre defined datum symbol
ISO/TS 1735	Pre defined datum 2d symbol
ISO/TS 1736	Pre defined datum 3d symbol
ISO/TS 1737	Printed physical layout template
ISO/TS 1738	Product identification extension
ISO/TS 1739	Product rule
ISO/TS 1740	Requirement decomposition
ISO/TS 1741	Sequential laminate assembly design
ISO/TS 1742	Shape composition
ISO/TS 1743	Shape parameters
ISO/TS 1744	Shield
ISO/TS 1745	Signal
ISO/TS 1746	Software
ISO/TS 1747	Specification document
ISO/TS 1748	Stratum non planar shape
ISO/TS 1749	Styled curve
ISO/TS 1750	Text representation
ISO/TS 1751	Test requirement allocation
ISO/TS 1752	Thermal network definition
ISO/TS 1753	Value with unit extension
ISO/TS 1754	Via component
ISO/TS 1755	Physical connectivity definition
ISO/TS 1756	Conductivity material aspects
ISO/TS 1757	Test select product
ISO/TS 1758	Promissory usage in product concept
ISO/TS 1759	Ap210 datum difference based model definition
ISO/TS 1760	Pre defined product data management specialisations

For more information on the concept and architecture of STEP Application Module Development, visit the following web site: <http://stepmod.sourceforge.net/>

Selective pilot/prototype testing of modular extensions of AP203 with modules is being done in the Joint PDES, Inc./ProSTEP CAX - Implementors Forum (CAX-IF).

Recommended Practices Guides (RPGs) exist for these modules and several others and can be found on the PDES, Inc. public web site.

## **"PDES, Inc. Developed Recommended Practices Documents:**

[http://pdesinc.aticorp.org/recommended\\_practices.html](http://pdesinc.aticorp.org/recommended_practices.html)

AP203 Recommended Practices  
AP209 Recommended Practices  
AP210 Concept of Operations  
AP232 Recommended Practices

## **PDES, Inc. and ProSTEP Developed Recommended Practices Documents:**

PDM Schema Usage Guide  
3-D Associative Text Recommended Practices  
Recommended Practices for Dimensions and Dimensional Tolerances  
Recommended Practices for Form Features: Round Hole, Thread and Compound Features  
Recommended Practices for Colors and Layers  
Recommended Practices for Model Viewing  
Recommended Practices for Geometric Validation Properties"

Other Recommended Practices Guides (RPG's) are in preparation, including AP226 and AP227.

## **2.5 STEP and XML, STEPml, Implementation Methods**

Many businesses are turning to XML-based business-to-consumer (e.g. e-retailing) and business-to-business (e.g. e-marketplace) solutions to reduce transaction costs, open new markets and better serve their customers. These solutions require basic information about products. Missing from these solutions is the business information concerning the design, manufacture and support of these goods. This information, referred to as product data, has a life that starts when the product is first conceived and runs through product development, manufacture, delivery, support and retirement. Solutions in these areas are the domain of STEPml.

Applications must understand content and concepts of business domains to create what Berners-Lee, director of the W3C (the consortium developing XML and related standards), calls a 'semantic' Web. In a recent IEEE Computer article (December 1999 issue) Berners-Lee is quoted as saying, 'vendors and users must develop standard ways of using the technology [web - inserted], so applications will be interoperable'.

STEPml is a library of XML specifications -- Document Type Definitions (DTDs) and/or XML Schemas -- for product data. STEPml's content is based on information models from STEP, the international product data representation and exchange standard (ISO 10303).

This STEPml specification addresses the requirements to identify and classify or categorize products, components, assemblies (ignoring their structure) and/or parts. Identification and classification are concepts assigned to a product by a particular organization. This specification describes the core identification capability upon which additional capabilities, such as product structure, are based.

### **Scope statement**

The following are within the scope of the STEPml specification:

- identifying products using a string value that is unique within the organization that assigned the value for a type of product;
- representing the name of a product;

- representing an optional description of a product;
- representing the categorization of the product;
- the specification of a data structure to identify an organization;
- the specification of a data structure to identify a person;
- the specification of a data structure to relate a person to an organization;
- the specification of a data structure to represent an address;
- an organization may have a related address;
- a person in an organization may have a related address;
- all identified people must be related to organizations;
- the assignment of an organization to product data;
- the assignment of a person in an organization to product data;
- specifying a data structure to record the names of categories for products;
- specifying a data structure to optionally record the description or definition of a product category;
- specifying a data structure to relate product categories in a hierarchical manner;
- optionally recording what organisation or person in organisation defines a category for a product.

The following are outside the scope of this specification:

- representing product version information;
- representing product structure (e.g. assembly or BOM) information;
- representing change management information related to a product.

These additional capabilities are or will be addressed in other STEPml specifications.

For more information on the concept and architecture of STEPml, visit the following web site: <http://www.stepml.org/index.html> .

## 2.5.1 Parts 21, 25 & 28

### Part 21

**STEP-File** is the most widely used data exchange form of STEP. Due to its ASCII structure it is easy to read with typically one instance per line. The format of a STEP-File is defined in ISO 10303-21 **Clear Text Encoding of the Exchange Structure**. ISO 10303-21 defines the encoding mechanism on how to represent data according to a given EXPRESS schema, but not the EXPRESS schema itself. STEP-File are also called **p21-File** and **STEP Physical File**. The file extensions **.stp** and **.step** indicate that the file contain data conforming to STEP Application Protocols.

### Part 28

Part 28 provides a representation of data according to the syntax of Extensible Markup Language (XML) defined using ISO 10303-11 (the EXPRESS language) and/or for EXPRESS schemas. The mappings are specified from the EXPRESS language to the syntax of the representation. Any EXPRESS schema or schemas and the data they describe can be represented. (Note: the original Part 28 was subsequently split into two parts --- a revised Part 28 and a Part 25. They are both being developed as Technical Specifications (TS).)

```

ISO-10303-21;
HEADER;
FILE_DESCRIPTION(
/* description */ ('A minimal AP214 example with a single part'),
/* implementation_level */ ('2;1'));
FILE_NAME(
/* name */ ('demo',
/* time_stamp */ ('2003-12-27T11:57:53',
/* author */ ('Lothar Klein'),
/* organization */ ('LKSoft'),
/* preprocessor_version */ (' '),
/* originating_system */ ('IDA-STEP',
/* authorization */ (' '));
FILE_SCHEMA (('AUTOMOTIVE_DESIGN { 1 0 10303 214 2 1 1}'))
ENDSEC;
DATA;
#10=ORGANIZATION('O0001','LKSoft','company');
#11=PRODUCT_DEFINITION_CONTEXT('part definition',#12,'manufacturing');
#12=APPLICATION_CONTEXT('mechanical design');
#13=APPLICATION_PROTOCOL_DEFINITION('automotive_design',2003,#12);
#14=PRODUCT_DEFINITION('0',$,#15,#11);
#15=PRODUCT_DEFINITION_FORMATION('1',$,#16);
#16=PRODUCT('A0001','Test Part 1','',(#18));
#17=PRODUCT_RELATED_PRODUCT_CATEGORY('part',$,(#16));
#18=PRODUCT_CONTEXT('',#12,'');
#19=APPLIED_ORGANIZATION_ASSIGNMENT(#10,#20,(#16));
#20=ORGANIZATION_ROLE('id owner');
ENDSEC;
END-ISO-10303-21;

```

## Figure 2 — Example of a STEP Part 21 file

Scope. "This part of ISO 10303 specifies use of the Extensible Markup Language (XML) to represent schemas specified using the EXPRESS data specification language, ISO 10303-11, and data that is governed by EXPRESS schemas. The following are within the scope of this part of ISO 10303:

- specification of XML markup declarations that enable EXPRESS schemas to be represented using XML
- specification of a single XML markup declaration set that is independent of the EXPRESS schema and formally describes the XML representation of data governed by any schema [NOTE 1: XML markup declarations specified using this method are referred to as late bound, in that they may be used without change to represent data governed by any EXPRESS schema. This part of ISO 10303 allows for a number of choices in representing the data]
- for an arbitrary EXPRESS schema, specification of an XML markup declaration set that corresponds to the schema and formally describes the XML representation of data

governed by that schema [NOTE 2: XML markup declarations specified using these methods are referred to as early bound, in that they are specific to a given EXPRESS schema.]

- specification of the mapping between XML markup declarations corresponding to a specific schema and the XML markup declarations independent of any schema
- specification of the form of XML documents containing EXPRESS schemas and data governed by EXPRESS schemas
- specification of the representation of EXPRESS primitive data type values as element content and as XML attribute values.

Summary of bindings in Part 28, an ISO project standardizing mappings from EXPRESS to XML:

- EXPRESS DTD for schema exchange: Maps *all* of EXPRESS *syntax* into XML
- EXPRESS/UML/XMI for schema exchange: Maps a subset of EXPRESS concepts to OMG UML Meta-model Class Diagram concepts for OMG XMI use; requires Part 28, OMG XMI specification and OMG UML
- Late Binding DTD for data exchange: Maps EXPRESS simple, defined and entity type instances into XML document; is an SGML 'architecture DTD' for ETEB
- EXPRESS-Typed Early Binding (ETEB): Maps as much of EXPRESS typing into DTD as possible; is architecturally related to Late Binding
- Object Serialization Early Binding: Maps EXPRESS into XML that is parallel to programming language constructs; EXPRESS not visible in the DTD; mapped to Late Binding via XSLT
- Containment Early Binding (maybe): Maps a subset of EXPRESS to simple XML using containment; human readability is considered; Making 'STEP' (*i.e.*, APs) simple is considered; see the OSEB diagrams as CEB fits into the architecture in the same manner.

## Part 25

Part 25 provides a mapping of EXPRESS into the physical meta-model of UML enabling OMG XMI.

### ISO/TS 10303-28 Implementation methods: XML representation for EXPRESS driven data

This part of ISO 10303 specifies means by which data and schemas specified using the EXPRESS language (ISO 10303-11) can be encoded using XML. XML provides a basic syntax that can be used in many different ways to encode information. In this part of ISO 10303, the following uses of XML are specified:

- a) A late bound XML architectural element declaration set that enables any EXPRESS schema to be encoded;
- b) An extension to the late bound element declaration set to enable data corresponding to any EXPRESS schema to be encoded as XML;
- c) An early bound declaration set that uses the late bound set as its basis;
- d) The use of SGML architectures to enable further XML forms to be defined that are compatible with the late bound declaration set;

- e) A mapping from the EXPRESS language to the XML Meta-data Interchange format;
- f) An object based XML binding that is specialised to meet requirements for inter-process communication.

The use of architectures allows for different early bindings to be defined that are compatible with each other and can be processed using the architectural elements.

#### Scope

This part of ISO 10303 specifies use of the Extensible Markup Language (XML) to enable the transfer of schemas specified using the EXPRESS data specification language (ISO 10303-11) and data that is governed by EXPRESS schemas.

The following are within the scope of this part of ISO 10303.

- Specification of XML element declarations that enable any EXPRESS schema to be encoded using XML.
- Specification of XML element declarations that enable data that is governed by any EXPRESS schema to be encoded as XML. (NOTE: XML element declarations specified using this method are referred to as late bound, in that they are independent of any EXPRESS schema. This specification allows for a number of choices for encoding the data.)
- Methods for the specification of XML element declarations that enable data that is governed by a specific EXPRESS schema to be encoded as XML, where the mapping from the EXPRESS language and XML is independent of the characteristics of any specific EXPRESS schema. (NOTE: XML element declarations specified using these methods are referred to as early bound, in that they are specific to a given schema.)
- Methods for the specification of the correspondence between XML element declarations that enable encoding of data governed by a specific schema (early bound) and XML element declarations that enable encoding of data governed by any schema (late bound).
- Specification of a mapping from EXPRESS to the XML Metadata Interchange (XMI) Document Type Definition.

The following are **outside** the scope of this part of ISO 10303.

- Methods for the specification of XML declarations that enable data that is governed by a specific EXPRESS schema to be encoded as XML, where the mapping from the EXPRESS language and XML is dependent on the characteristics of the specific EXPRESS schema.
- Specification of mappings from XML element declarations to an EXPRESS schema. (NOTE: Given a set of XML element declarations and one or more corresponding data sets, it is feasible to create an EXPRESS schema that describes the data. However, this requires an understanding of the meaning and use of the data that may not be captured by the XML element declarations.)
- Methods for recreation of an EXPRESS schema from an XML encoding of that schema;
- Methods for recreation of an EXPRESS schema from XML element declarations that have been derived from the schema.

#### **ISO/TS10303-25 Implementation methods: EXPRESS to OMG XMI binding**

“The Object Management Group (OMG) has standardized the XML Metadata Interchange specification (XMI) that integrates the OMG Unified Modeling Language (UML) , the OMG Meta-Object Facility (MOF) and the World Wide Web Consortium (W3C) Extensible Markup Language (XML) standards. XMI is a mechanism for the interchange of metadata between UML-based modeling tools and MOF-based metadata repositories. OMG has also standardized an XMI compliant interchange format for the UML thus specifying a lexical representation of UML models based on a standardized metamodel of the

UML. That lexical representation includes, among other things, the ability to interchange data type information, class information (or entities), groupings of classes providing namespaces for the classes (or schemas), associations between classes and inheritance between classes (or subtypes).”

This part of ISO 10303 specifies a mapping of EXPRESS constructs into the UML Interchange Metamodel for XMI use.

The following are **within** the scope of this part of ISO 10303:

Mappings for EXPRESS constructs that appear in UML Static Structure Diagrams;

The following are **outside** the scope of this part of ISO 10303:

- Mappings of EXPRESS constructs into UML for purposes other than XMI use;
- Mappings for EXPRESS expressions into any representation in XMI;
- Mappings from UML into EXPRESS.

Implementations of this part of ISO 10303 shall support one or more of the following mechanisms for interchange based on the mappings specified in this part of ISO 10303:

- the XMI 1.1 based UML 1.4 DTD;
- the XMI 1.0 based UML 1.3 DTD;
- the XMI 1.1 based UML 1.3 DTD;
- any later XMI or XMI-related specification defining a representation of UML 1.4 (or UML 1.4 equivalent UML 1.3) for UML model interchange.

Not all EXPRESS constructs are mapped as UML does not support everything that EXPRESS supports. EXPRESS schemas, being data specifications, are mapped into concepts in UML that appear in UML Static Structure Diagrams.

In the following three (3) sections, the scope is given for each of the AP's that have been published as ISO 10303 standards, those that are considered "soon to be IS", and those that are still in the process of being developed. The conformance classes associated with each of the AP's that have achieved IS status are also provided, as well as many of those that are still in development. The intention here is to provide the engineering user with a view of the robustness of the STEP AP's and the potential usefulness of implementations of the associated conformance classes. It is the engineering user who must drive commercial (or internal) implementations of STEP AP conformance classes.

For more information on the concept and architecture of STEP/EXPRESS and XML, visit the following web site: <http://xml.coverpages.org/stepExpressXML.html> .

## **2.6 Scopes and Conformance Classes of Application Protocols (AP) with IS Status**

These scope descriptions are taken from the SC4 Project Management Database that was last updated on SC4ONLINE (<http://www.tc184-sc4.org/>) on Mach 21, 2006. The conformance class descriptions are taken from Clause 6 of the International Standard (IS), Draft International Standard (DIS), or Committee Draft (CD) document as appropriate for the current stage of the AP. The AP's which have achieved IS status are listed first.



It should be noted that a conformance class of an ISO 10303 Application Protocol specifies a meaningful part of the AP, **all** of which must be supported by an implementation. Conformance to a particular conformance class requires that all AIM entities, types, and associated constraints defined as part of that class be supported. Conformance to a particular conformance class requires conformance to each conformance class included in that class. Conformance to a particular conformance class requires that all Application Resource Model (ARM) constraints for the Units of Functionality (UoF's) implemented by this class be supported. (Clause 6 of the Standard spells out the details of each conformance class.)

This section is intended to give the engineering user insight into the coverage of the specific AP to assist in determining what an implementation of some or all of the conformance classes of this AP can provide to this user. If more detail is needed, the reader is referred to Clause 6 of the Standard itself.

## **2.6.1 AP201**

### **Explicit Draughting (ISO 10303-201:1994)**

"This part of ISO 10303 is applicable to the inter-organization exchange of computer-interpretable drawing information and product definition data.

#### **2.6.1.1 Scope**

The following are **within** the scope of this part of ISO 10303:

- The representation of drawings for the purpose of exchange, especially for mechanical engineering, architectural engineering, and construction applications;
- The representation of the real size of a product depicted in a drawing to enable use by applications where true geometric equivalence is required;
- (The representation of the shape of the product is required to support not only visual equivalence of exchanged drawings but also where true geometric equivalence is required by the receiving system. Such uses include the calculations of distances or areas and the generation of numerical control tool paths.)
- The representation of a drawing that depicts any phase of the design;
- The representation of individual drawing revisions;
- The representation of the two-dimensional draughting shape model depicting the product shape and the Transformations used for the generation of the drawing views;
- The presentation of non-shape product definition data depicted in a drawing by two-dimensional annotations;
- The hierarchical structure of drawings, drawing sheets, and views of the draughting shape model;
- The mechanisms for the grouping of the elements depicted on a drawing;
- The administrative data used for the purpose of drawing management;
- The administrative data identifying the product versions being documented by the drawing.

#### **2.6.1.2 Outside scope**

The following are **outside** the scope of this part of ISO 10303:

- The representation of the shape of a product using three-dimensional geometry;
- The representation of the shape of a product that is not depicted in a drawing;
- The representation of drawings that are not related to a product;
- The exchange of drawing history;
- The definition of annotation in three-dimensional coordinate systems;

- The presentation of dimensions and annotation that are associated to viewed geometry and annotation;
- A computer-interpretable bill of material structure except as conveyed by annotation on the drawing;
- Strict enforcement of draughting standards;
- Drawings containing non-displayable attribute data other than that required as administrative data (e.g., density, mass, or moment of inertia);
- The automatic generation of drawings including views, dimensions, and annotation.
- The exchange of data used exclusively for the creation of paper or hardcopy versions of the drawing (e.g., pen designations, plot scale, or plot color specifications)."

### **2.6.1.3 Conformance Classes**

AP201 is a single Conformance Class - Explicit Draughting.

## **2.6.2 AP202**

### **Associative Draughting (ISO 10303-202:1996)**

"This part of ISO 10303 provides for the inter-organization exchange of computer-interpretable drawing information and associated product definition data.

#### **2.6.2.1 Scope**

The following are **within** the scope of this part of ISO 10303:

- The structures for representing drawings for the purpose of exchange, suitable for mechanical engineering and Architecture, Engineering, Construction (AEC) applications;
- The structures for representing a drawing that depicts any phase of the life cycle of a product;
- The structures for representing individual drawing revisions;
- The structures for representing the two-dimensional or three-dimensional product shape;
- The structures for representing the transformations of the shape model used for the generation of the drawing views;
- The hierarchical structure of drawings, drawing sheets, and views of the draughting shape model;
- The presentation of non-shape product definition data depicted in a drawing by two-dimensional annotation or planar annotation defined in a three-dimensional coordinate space;
- Mechanisms for the grouping of the elements depicted on a drawing;
- The administrative data used for the purpose of drawing management;
- The administrative data identifying the product versions being documented by the drawing;
- The structures for representing associations between dimensions or draughting callouts and their respective target product shape geometry or annotation;
- The structures for representing associations between the boundaries of a fill area and the product shape geometry or annotation from which they are derived;
- Seven classes of draughting shape models used to represent product shape which include advanced boundary representation, faceted boundary representation, elementary boundary representation, manifold surfaces with topology, surface or wireframe geometry without topology, wireframe geometry with topology, and elementary curve sets;
- The presentation of dimensions and annotation that may be, but need not be, associated with viewed geometry or annotation.

### 2.6.2.2 Outside scope

The following are **outside** the scope of this part of ISO 10303:

- A draughting shape model that is not depicted in a drawing nor used as a constituent of another draughting shape model;
- The structures for representing drawings that are not related to a product;
- The structures for defining the relationship between multiple drawings;

**Note** - Drawings could be related to document the assembly structure of a part or define the history between multiple versions of the same drawing.

- Non-planar annotation defined in a three-dimensional coordinate space;
- A bill of material presented on the drawing by annotation where the information is interpretable to a computer as a bill of materials;
- Enforcement of conventions and rules found in draughting standards;
- This part of ISO 10303 supports the use of draughting standards but does not redefine them.
- The exchange of non-displayable attribute data other than that required as administrative data (e.g., density, mass, or moment inertia);
- The automatic generation of drawings including views, dimensions, and annotations;
- The exchange of data used exclusively for the creation of paper or hard copy versions of the drawing (e.g., pen designations, plot scale, or plot colour specifications);
- The presentation of the shape of a product in a two-dimensional view using light sources and shading;
- The association between geometric tolerances and related geometric elements;

**Note** - A geometric tolerance as described above is a combination of geometric characteristics symbols, tolerance values, and datum references, where applicable, to express the permissible variation from the theoretically exact size, profile, orientation, or location of a feature or datum target. Each of the three possible components, geometric characteristic symbols, tolerance values, and datum references are computer-identifiable but not computer-interpretable and, therefore, cannot be associated to geometric elements.

- The association between computer-recognizable limit dimensions and shape geometry or annotation."

### 2.6.2.3 Conformance Classes

AP202 has 10 Conformance Classes, the conformance classes are characterized as follows:

- cc 1: Administration, annotation, data organization (layers, groups), and drawing structure presentation (colors, fonts) without shape
- cc 2: cc 1 and elementary 2D geometrically bounded wireframe
- cc 3: cc 1 and all 2D geometrically bounded wireframe
- cc 4: cc 1 and 2D topological wireframe
- cc 5: cc 1 and 3D geometrically bounded wireframe and/or surfaces
- cc 6: cc 1 and 3D topological wireframe
- cc 7: cc 1 and faceted B-Rep
- cc 8: cc 1 and elementary B-Rep
- cc 9: cc 1 and advanced B-Rep
- cc 10: cc 1 and manifold surface models with topology

### 2.6.3 AP203

## Configuration Controlled 3D Designs of Mechanical Parts and Assemblies (ISO 10303-203:1994)

### 2.6.3.1 Scope

" The following are **within** the scope of this part of ISO 10303:

- Products that are mechanical parts and assemblies;
- Product definition data and configuration control data pertaining to the design phase of a product's development;
- The change of a design and data related to the documentation of the change process;
- Five types of shape representations of a part that include wireframe and surface without topology, wireframe geometry with topology, manifold surfaces with topology, faceted boundary representation, and boundary representation;
- Alternate representation of the data by different disciplines during the design phase of a product's life cycle;
- Identification of government, industry, company or other specifications for design, process, surface finish, and materials which are specified by a designer as being applicable to the design of the product;
- The identification of government, industry, company, or other standard parts for the purpose of their inclusion in a product's design;
- Data that are necessary for the tracking of a design's release;
- Data that are necessary to track the approval of a design; a design aspect, or a configuration control aspect of a product;
- Data that identify the supplier of either the product or the design and, where required by an organization, qualification information for the supplier;
- If a part is being designed under a contract, the identification of , and reference to, that contract under which a design is developed;
- The identification of the security classification of a single part or a part when it is a component in an assembly;
- Data that is used in, or results from, the analysis or test of a design which is used as evidence for consideration of a change to a design.

### 2.6.3.2 Outside scope

The following are **outside** the scope of part of ISO 10303:

- Data that is used in, or results from, the analysis or test of a design that is not used as evidence for consideration of a change to a design;
- Data that results in changes to the design during the initial design evolution prior to its release;
- Product definition data and configuration control data pertaining to any life cycle phase of a product's development other than design;
- The business data for the management of a design project;
- Alternate representations of the data by different disciplines outside of the design phase (e.g., manufacturing);
- The use of constructive solid geometry for the representation of objects;
- Data that pertains to the visual presentation of any of the shape or configuration control data."

### **2.6.3.3 Conformance Classes**

AP203 (Edition 1) has 12 Conformance Classes, the conformance classes are characterized as follows:

- cc 1a, b: Configuration controlled-design information without shape (cc 1a is a specified "product identification" subset of cc 1b)
- cc 2a, b: cc 1a, b and 3D geometrically bounded wireframe and/or surface models
- cc 3a, b: cc 1a, b and 3D wireframe models with topology
- cc 4a, b: cc 1a, b and manifold surface models with topology
- cc 5a, b: cc 1a, b and faceted B-Rep
- cc 6a, b: cc 1a, b and advanced B-Rep

### **2.6.3.4 AP203 – second edition**

#### **Configuration Controlled 3D Designs of Mechanical Parts and Assemblies (ISO/TS 10303-203:2004)**

Edition 2 - Will be Modularized – Colours & Layers, Validation Properties, Construction History, Validation Properties, Dimensions and Tolerances will be added to the scope, and the Configuration Management data (cc 1a & cc 1b) will be replaced by the PDM Schema/Modules.

#### **2.6.3.4.1 Scope**

This part of ISO 10303 specifies the application module Configuration control 3d design ed2. The following are within the scope of this part of ISO 10303:

products that are mechanical parts and assemblies;

product definition data and configuration control data pertaining to the design phase of a product's development;

representation of an instance of a part in an assembly through its usage in a sub-assembly;

six groups of shape representations of a part that includes advanced boundary representation, faceted boundary representation, manifold surfaces with topology, geometrically bounded surface and wireframe geometry, wireframe with topology, and constructive solid geometry in three-dimensions;

geometric validation properties to allow the translation of geometric shape representations (advanced boundary representation and faceted boundary representation solids) to be checked for quality;

geometric presentation of geometric shape representations by the application of colours, layers and groups;

geometric and dimensional tolerances applied to geometric shape representations;

textual annotation and notes applied to geometric shape representations.

#### **2.6.3.4.2 Outside scope**

The following are outside the scope of this part of ISO 10303:

business data for management of a design project;

data that results in change to the design during the initial design evolution prior to release;

product definition data and configuration control data pertaining to any life cycle phase other than design.

### 2.6.3.4.3 Modules

**Table 8 — AP203 modules**

Application module	Application module	Application module
ISO/TS 10303-1001:2001	ISO/TS 10303-1064:2003	ISO/TS 10303-1019:2003
ISO/TS 10303-1017:2003	ISO/TS 10303-1364:2003	ISO/TS 10303-1034:2003
ISO/TS 10303-1047:2003	ISO/TS 10303-1128:2003	ISO/TS 10303-1041:2003
ISO/TS 10303-1049:2003	ISO/TS 10303-1033:2003	ISO/TS 10303-1061:2003
ISO/TS 10303-1514:2003	ISO/TS 10303-1512:2003	ISO/TS 10303-1030:2003
ISO/TS 10303-1025:2003	ISO/TS 10303-1127:2003	ISO/CD TS 10303-1228
ISO/CD-TS 10303-1001	ISO/TS 10303-1006:2003	ISO/TS 10303-1015:2003
ISO/TS 10303-1012:2003	ISO/CD TS 10303-1051	ISO/CD TS 10303-1009
ISO/CD-TS 10303-1132	ISO/TS 10303-1039:2003	ISO/TS 10303-1032:2003,
ISO/TS 10303-1044:2003	ISO/TS 10303-1507:2003	ISO/TS 10303-1502:2003
ISO/TS 10303-1114:2003	ISO/TS 10303-1510:2003	ISO/TS 10303-1065:2003
ISO/TS 10303-1058:2003	ISO/TS 10303-1021:2003	ISO/CD TS 10303-1365
ISO/TS 10303-1056:2003	ISO/CD TS 10303-1349	ISO/TS 10303-054:2003
ISO/CDTS 10303-1131	ISO/TS 10303-1036:2003	ISO/TS 10303-1043:2003
ISO/TS 10303-1068:2003	ISO/TS 10303-1038:2003	ISO/TS 10303-1042:2003
ISO/TS 10303-1062:2003	ISO/CD TS 10303-1288	
ISO/TS 10303-1003:2001	ISO/TS 10303-1509:2003	
ISO/TS 10303-1014:2003	ISO/TS 10303-1105:2003	
ISO/CD TS 10303-1052	ISO/TS 10303-1022:2003	
ISO/CD TS 10303-1130	ISO/TS 10303-1055:2003	
ISO/CD TS 10303-1050	ISO/TS 10303-1023:2003	
ISO/TS 10303-1121:2003	ISO/TS 10303-1011:2003	
ISO/TS 10303-1122:2003	ISO/TS 10303-1013:2003	
ISO/TS 10303-1123:2003	ISO/TS 10303-1040:2003	
ISO/CD TS 10303-1290	ISO/TS 10303-1016:2003	
ISO/TS 10303-1124:2003	ISO/TS 10303-1060:2003	
ISO/TS 10303-1501:2003	ISO/TS 10303-1046:2003	
ISO/TS 10303-1059:2003	ISO/CD TS 10303-1134	
ISO/TS 10303-1057:2003	ISO/TS 10303-1018:2003	
ISO/TS 10303-1004:2003	ISO/TS 10303-1020:2003	

### 2.6.3.4.4 Conformance Classes

This part of ISO 10303 provides for only one option that may be supported by an implementation:  
cc1: configuration control of 3D design of mechanical parts and assemblies.

This option shall be supported by a single class of conformance that consists of all the ARM elements defined in the AP module (ISO 10303-403).

Conformance to a particular class requires that all ARM elements defined as part of that class be supported.

The conformance class, **configuration control of 3D design of mechanical parts and assemblies** has been declared against the module: Configuration control 3d design ed2 (ISO 10303-403).

**NOTE** - Conformance to configuration control of 3D design of mechanical parts and assemblies requires that all ARM and MIM elements defined in the AP module, (ISO 10303-403), be supported.

The scope of the **configuration control of 3D design of mechanical parts and assemblies** conformance class is:

configuration control information;  
document management;  
effectivity;  
product identification data;  
product data management information;  
product structure;  
presentation;  
shape representations;  
product data management information;  
configuration information;  
effectivity;  
product structure;  
configuration control information;  
geometric dimensions and tolerances;  
advanced B-rep;  
constructive solid geometry;  
assembly information;  
product structure information.

## **2.6.4 AP204**

### **Mechanical design using boundary representation (ISO 10303-204:2002)**

This document describes an application reference environment for the generation and exchange of volume based design data in the Computer Aided Mechanical design process, together with appropriate data models and a physical file implementation form. The information model supports all geometric and topological aspects of a complete description of the shape and size of an object.

It was originally developed for applications in mechanical engineering design using the CAD modelling technique boundary representation (B-rep) solid modelling and may be appropriate for other application areas using this technique.

#### **2.6.4.1 Scope**

The following are within the scope of this Part of ISO 10303:

- Three types of B-rep model that are used to represent shape:
  - a) faceted B-rep model;
  - b) B-rep model with elementary surfaces;
  - c) B-rep model with sculptured surfaces;
- curve and surface geometry;
- curves defined in parameter space (pcurves);
- manifold topology;

- product identification information;
- the association of simple presentation attributes such as line-style, line-width, colour with a B-rep model or with geometric or topological elements;
- preservation of user-defined names of objects;
- units and measures associated with geometric elements;
- assemblies of parts and sub-assemblies.

#### **2.6.4.2 Outside scope**

The following are outside the scope of this Part of ISO 10303:

- Other types of shape representation:
  - a) wireframe models;
  - b) surface models;
  - c) geometrically trimmed curves and surfaces;
  - d) constructive solid geometry models;
  - e) compound B-rep models.
- Geometric and topological data:
  - a) 2D geometry;
  - b) self-intersecting geometry;
  - c) non-manifold topology.
- Dimensioning;
- Tolerances;
- Manufacturing information;
- Advanced presentation features, such as multiple views, character fonts, symbols;
- Material information;
- Meshing information;
- Analysis models, such as finite element analysis.

#### **2.6.4.3 Conformance Classes**

This Part of ISO 10303 provides for a number of options that may be supported by an implementation. These options have been grouped into the following conformance classes.

Class 1: B-rep level 1: The definition of a mechanical engineering product model where the shape is represented by one or more faceted brep models.

Class 2: B-rep level 2: The definition of a mechanical engineering product model where the shape is represented by one or more elementary brep models.

Class 3: B-rep level 3: The definition of a mechanical engineering product model where the shape is represented by one or more advanced brep models.

Support for a particular conformance class requires support for all the options specified in that class.

NOTE 1 - ISO 10303-1204 defines the abstract test suite and test purposes to be used in the assessment of conformance.



General requirements for all classes are:

- a) The information requirements and relationships of the ARM shall be preserved in the implementation. This includes support for all valid combinations of entities and their attributes. No 'substitution' of entities shall be permitted. Consequently all construct assertions from clause 4 shall be maintained.
- b) All AIM entities, types, and their associated constraints shall be supported. Treatment of options and default values shall conform to the AIM.
- c) All AIM entities, types, and their associated constraints shall be read and processed by a postprocessor.

## **2.6.5 AP207**

### **Sheet Metal Die Planning and Design (ISO 10303-207:1999)**

"This part of ISO 10303 specifies the use of the integrated resources necessary for the scope and information requirements for exchange of information between contractors and suppliers to enable the eventual manufacture of sheet metal dies used in the production process of sheet metal parts.

#### **2.6.5.1 Scope**

The following are **within** the scope of this part of ISO 10303:

- Types of product supported: (This list describes the types of product for which data is in scope. The products themselves are not in scope, because they are not data.)
  - a) Sheet metal part design data (Sheet metal part designs may be for sheet metal parts intended for the exterior of a product, those intended for the interior of a product, those intended to be in view on the final product, or those intended to support loads or maintain structure of a product. Sheet metal part designs may also be for sheet metal parts that are products in themselves.);
  - b) Sheet metal die design data, including die face design and die structure design, for an individual die against which sheet metal is formed by processes that do not involve a mating die;
  - c) Sheet metal die set design data, including die face design and die structure design, for die sets used in a stamping press machine to manufacture sheet metal parts;
  - d) Sheet metal part manufacture description data.
- Types of product data supported:
  - a) Design data for materials, sheet metal in-process parts, sheet metal parts, die components, individual dies, and dies sets;
  - b) Process data for sheet metal part manufacture;
  - c) Change and schedule data for design of product definition data and manufacture description data;
  - d) Data ownership, generating system information, and exchange history surrounding product definition data and manufacture description data;
  - e) The identification of externally designed parts and purchased items;
  - f) Design constraints on dies;
  - g) Wireframe, surface, and solid geometry;
  - h) Data describing the relative position of materials and in-process sheet metal parts to the die or dies that will further form them;
  - i) Composition of materials, sheet metal parts, and die components;

- j) (10) Properties associated with materials or with collections of geometric representations, such as hardness, porosity, method of manufacture, and function.
- Stages in the product life cycle supported are data at any stage of completion that describes:
  - a) Materials;
  - b) Sheet metal in-process parts and sheet metal parts;
  - c) Die components, individual dies, and die sets;
  - d) Sheet metal part manufacture description data;
  - e) Change and schedule data for design of product definition data and manufacture description data.
- The supported exchange scenarios from contractor to supplier are as follows:
  - a) Requirements to enable the supplier to create a sheet metal part processing plan for the contractor, such as the sheet metal part design, available presses and plants, and plant and press constraints;
  - b) Requirements to enable the supplier to create a die design for the contractor, such as the sheet metal part design and the sheet metal part processing plan. This design may be for the die face, or for the die structure, or for both;
  - c) Exchanges wherein the contractor and supplier are divisions of the same company;
  - d) Exchanges wherein the contractor and supplier are different companies.
- The supported exchange scenarios from supplier to contractor are as follows:
  - a) As part process plan or any portion thereof;
  - b) A complete die design or any portion thereof;
  - c) A die face design or any portion thereof;
  - d) A die structure design or any portion thereof;
  - e) A change request;
  - f) Exchanges wherein the contractor and supplier are divisions of the same company;
  - g) Exchanges wherein the contractor and supplier are different companies.

### 2.6.5.2 Outside scope

The following are **outside** the scope of this part of ISO 10303:

- Parts that are not made of sheet metal or are not manufactured by a process involving the use of a die or dies;
- Sheet metal parts that are manufactured by explosive forming or forging;
- The design of devices used to stretch sheet metal over single convex dies, or the rubber bladder or sheet used in hydroforming or trap rubber forming to force sheet metal into a single concave die;
- Parametric or variational geometry models of sheet metal parts, dies, or die components;
- Engineering analysis data of any kind;
- Financial data of any kind;
- Manufacturing process data for sheet metal dies;
- Any exchange uses of data in order to:
  - a) enable the initial design of sheet metal parts;
  - b) enable the design of checking fixtures;
  - c) enable the manufacture of the die.
- Data related to production runs of sheet metal parts."

### 2.6.5.3 Conformance Classes

AP207 has 14 Conformance Classes, the conformance classes are characterized as follows:

- cc 1: Product management (PM) and identification information without shape
- cc 2: cc 1 and sheet metal part process plan data without shape
- cc 3: cc 1 and shapes represented by topologically bounded wireframe models
- cc 4: cc 1 and shapes represented by geometrically bounded wireframe and surface models
- cc 5: cc 1 and shapes represented by manifold surface models with topology
- cc 6: cc 1 and shapes represented by faceted B-Rep
- cc 7: cc 1 and shapes represented by advanced B-Rep
- cc 8: cc 1 and shapes represented by constructive solid geometry (CSG)
- cc 9: cc 2 and shapes represented by topologically bounded wireframe models
- cc 10: cc 2 and shapes represented by geometrically bounded wireframe and surface models
- cc 11: cc 2 and shapes represented by manifold surface models with topology
- cc 12: cc 2 and shapes represented by faceted B-Rep
- cc 13: cc 2 and shapes represented by advanced B-Rep
- cc 14: cc 2 and shapes represented by constructive solid geometry (CSG)

### 2.6.6 AP209

#### Composite and Metallic Structural Analysis and Related Design (ISO 10303-209:2001)

"This part of ISO 10303 specifies computer-interpretable composite and metallic structural product definition including their shape, their associated finite element analysis (FEA) model and analysis results, and material properties.

#### 2.6.6.1 Scope

The following are within the scope of this part of ISO 10303:

- the definition of composite structural parts;
- the definition of metallic structural parts;
- linear statics finite element analysis;
- the product definition and configuration control information pertaining to the design through analysis stages of a product's development;
- the information relating the part to the adjoining components in an assembly by either explicit or external reference;
- the 2D and 3D models depicting the product shape;
- the five types of geometric and topologic model representations which include:
  - a) wireframe and surface without topology;
  - b) wireframe geometry with topology;
  - c) manifold surfaces with topology;
  - d) faceted boundary representation; and
  - e) advanced boundary representation.
- the representations for design and analysis disciplines and the association of the design, idealized design and finite element node shape representations;
- the association of the constituents of composite and metallic parts with the constituent shape model;

- the depiction of composite laminate tables describing the material, stacking sequence, orientation, and constituents of the composite or a portion of the composite with a defined shape;
- the identification of material specifications from internal and external sources and their properties for a specific operating environment;
- the finite element analysis model, analysis controls, and analysis results information;
- the plane stress and simple plane strain types of linear static finite element structural analyses;
- the 2D vector graphical presentation of:
  - a) finite element model maps ;
  - b) analysis output information displays upon finite element model mesh;
  - c) line drawings which document the part aspects subjected to detail analyses
- the tabular presentation of the analysis assumptions, loadings, and critical locations in finite element and detail analyses performed for the assessment of the margin of safety;
- the administrative information necessary to track the approval and configuration control of the design and analysis of a product at a point in the life cycle when approval and configuration control are necessary;
- a change to a design and an analysis, including information to identify the change, at a point in the life cycle when tracking a change is necessary;
- the identification, when required, of the contract under which a design is developed and an analyses is performed;
- the identification of the security classification of a part.

#### **2.6.6.2 Outside scope**

The following are outside the scope of this part of ISO 10303:

- the business information for the management of a design and analysis project;
- the product definition and configuration control information pertaining to any information other than that necessary for design and analysis;
- alternate representation of the information by disciplines outside of design and analysis such as manufacturing;
- the use of constructive solid geometry for the representation of the shape of the product;
- the explicit representation of a bill-of-material;
- the other types of finite element analysis beyond linear statics, such as dynamic and non-linear statics;
- the explicit graphical presentations derivable from design or analysis product representations;
- specification of filament wound structures;
- the composite fabrication process information;

the product definition of initial or in-process part shapes.

#### **2.6.6.3 Conformance Classes**

AP209 has 10 Conformance Classes.

"...Support for a particular conformance class requires support of all the elements specified in that class.

Conformance to this part of ISO 10303 requires conformance to at least one of the primary conformance classes 7 through 10.

Classes 2 through 6 are the shape representation conformance classes that may be used for ISO 10303-209. One or more shape representation conformance classes may be selected by an implementation and combined with the primary conformance classes 7 through 10."

The conformance classes are characterized as follows:

- cc 1: Support for configuration control without shape information.
- cc 2: Support for Class 1 plus shapes represented by non-topological surface and wireframe.
- cc 3: Support for Class 1 plus shapes represented by wireframe with topology.
- cc 4: Support for Class 1 plus shapes represented by manifold surface with topology.
- cc 5: Support for Class 1 plus shapes represented by faceted boundary representation.
- cc 6: Support for Class 1 plus shapes represented by advanced boundary representation.
- cc 7: Support for material, part composite constituents, composite constituent representation, part laminate table, and zone composite constituents and their representation.
- cc 8: Support for Class 7 plus finite element analysis model and analysis report.
- cc 9: Support for Classes 7 and 8, plus finite element analysis control.
- cc 10: Support for Classes 7, 8 and 9, plus finite element analysis results.

## **2.6.7 AP210**

### **Electronic Assembly, Interconnect and Packaging Design (ISO 10303-210:2001)**

"ISO 10303-210 specifies the information requirements for the design of electrical printed circuit assemblies.

#### **2.6.7.1 Scope**

The following are **within** the scope of ISO 10303-210:

- The hierarchical description of the printed circuit assembly (PCA) that identifies the functional objects that are used in the PCA composition;
- The description of the functional objects that are combinations of one or more parts or functional objects;
- The configuration management of the functional objects that are being developed concurrently;
- The configuration management of analytical models that are being developed concurrently;
- The reference to analytic models that are used to define the behavior of a part or PCA or printed circuit board (PCB);
- The description of the connection among the functional objects, packaged parts, and the requirements for physical interconnection;
- The physical layout of the PCA, including a description of the placement of the parts and their interconnections;
- The description of the bare printed circuit board, including the conductive and non-conductive layers of the board;
- The functional and physical description of parts and components, both printed and packaged including material characteristics and composition;
- The description of the requirements and constraints on the design of the PCA that assure product performance, incorporate quality, and enhance manufacturing process capabilities;
- The configuration management of PCA descriptions;
- The description of PCAs and PCBs to implement various functional domains including, but not limited to, analog, digital, video, RF, and microwave;

- The configuration management of constituent parts that are PCAs and PCBs and are being concurrently developed;
- The allocation of requirements to functional objects, physical objects, and the physical implementation;
- The allocation of requirements from functional objects to their physical implementation;
- The configuration management of documents that contain requirements;
- The association of characteristics to functional objects, parts and components;
- The identification of actual parameters for parts and functional objects;
- The identification of planned parameters for functional objects, PCAs, and PCBs.

### 2.6.7.2 Outside scope

The following are **outside** the scope of ISO 10303-210:

- The presentation of the part and the PCA descriptions;
- The process plans for the fabrication of the PCB;
- The classification and categorization of data element types;
- The process plans for the assembly of the PCA;
- The definition and interpretation of external file formats for analytic models
- The management of the process used to design a PCA;
- The management of the manufacture of the parts used by a PCA;
- The administrative procurement and cost data used by an enterprise.

### 2.6.7.3 Conformance Classes

AP210 has 30 Conformance Classes, the conformance classes are characterized as follows:

- cc 1 - Device Functional and Physical Characterization
- cc 2 - Interconnect Technology Constraints
- cc 3 - Assembly Technology Constraints
- cc 4 - Assembly Functional Requirements
- cc 5 - Assembly Physical Requirements
- cc 6 - Interconnect Functional Requirements
- cc 7 - Interconnect Physical Requirements
- cc 8 - Assembly Physical Design
- cc 9 - Interconnect Design
- cc 10 - Interconnect Design (Microwave)
- cc 11 - Geometric Dimensioning and Tolerancing
- cc 12 - Product Rule
- cc 13 - Functional Decomposition
- cc 14 - Package Functional and Physical Characterization
- cc 15 - Geometrically Bounded Surface Model
- cc 16 - Wireframe Model with Topology
- cc 17 - Advanced Boundary Representation
- cc 18 - Constructive Solid Geometry
- cc 19 - Extruded Solid
- cc 20 - Geometrically Bounded 2d Wireframe Model
- cc 21 - Wireframe 2d Model with Topology
- cc 22 - Curve 2d

- cc 23 - Basic Curve 2d
- cc 24 - Laminate Assembly Design
- cc 25 - Connection Zone Based Model Extraction
- cc 26 - Functional Specification
- cc 27 - Physical Unit Physical Characterization
- cc 28 - Packaged Part White Box Model
- cc 29 - Printed Part Functional and Physical Characterization
- cc 30 - Open Shell Model

Conformance to this part of ISO 10303 requires conformance to one of the following:

- any combination of the conformance classes 1 through 7
- conformance class 8
- any combination of the conformance classes 9, 10, 24
- any combination of the conformance classes 24 through 29
- any combination of the conformance classes 13, 14

Conformance class 12 may be used for ISO 10303-210.

Conformance classes 15 through 23, and class 30, are shape representation conformance classes that may be used for ISO 10303-210.

Conformance to a particular conformance class requires that all AIM entities, types, and associated constraints defined as part of that class be supported.

Conformance to a particular conformance class requires conformance to each conformance class included in that class. All entities specified, either directly or indirectly, by required attributes of the required AIM entities shall be supported.

Conformance to a particular conformance class requires that all ARM constraints for UoFs implemented by this class be supported.

### **cc 1: Device Functional and Physical Characterization**

Device Data includes following information: device black box model, package data, functional data, environmental constraints, performance data, simulation models. Formal encapsulation of external data type definitions is made for parametric data and analysis models. Pin mapping is provided to ensure consistency between device views. Shape, material, technology, tolerance on shape and on parameters, units are included.

Shapes included may be categorized according to discipline (e.g. thermal analysis, vibration analysis), and analysis environment (e.g., design, assembly, end-user). Geometric Dimensioning and Tolerancing is included.

The functional data includes two distinct data sets: hierarchical functional decomposition into behavioural elements embedded in a network represented at each level by a nodal formulation; collection of device terminals (e.g., connector terminals, printed circuit board interface areas, jumper ends) that implement the functionality of a network node. Configuration management information and design management information is provided.

This data includes at least one geometric representation.

**cc 2: Interconnect Technology Constraints**

This Data includes all information provided to the design team by fabrication vendors from which may be derived default land and passage definitions, based on the desired yield for fabrication and assembly processes. Typical Data includes minimum annular ring, maximum passage aspect ratio, minimum deposition thickness, maximum terminal size supported for through hole technology class, and other critical material processing properties. Configuration management information and design management information is provided. This data includes at least one geometric representation.

**cc 3: Assembly Technology Constraints**

This Data includes all information provided to the design team by assembly vendors from which may be derived constraints on which packages may be selected, mounting arrangements to be specified, permitted mounting areas, clearances, etc. Typical bond shape for each unique assembly process is available. Extensive use of formal encapsulation of external data type definitions is made for parametric data. Configuration management information and design management information is provided. This data includes at least one geometric representation.

**cc 4: Assembly Functional Requirements**

This Data includes all information required to specify the behaviour of the assembly, including interface definition. Explicit structural definition is provided for the functional network, including representations of usage view and design view, representations of folded and elaborated network hierarchy. This includes gate allocation information. Explicit allocation of each functional network node to the implementing component is included. Extensive use of formal encapsulation is provided for signal definition, mathematical models, etc. This data includes information required to support embedded components in an interconnect product. Configuration management information and design management information is provided.

**cc 5: Assembly Physical Requirements**

This Data includes all information provided to the design team that may be represented by shape data, including customer requirements, and technology selected to implement those requirements. Explicit allowed volumetric shape, external connection locations are included. Component grouping, keepout, keepin, etc is included. This data includes information required to support embedded components in an interconnect product. Configuration management information and design management information is provided. Preferred parts and packages may be specified by inclusion in design library. This data includes at least one geometric representation.

**cc 6: Interconnect Functional Requirements**

This Data includes the device data from conformance class 1 (only the functional device information) specific to an interconnect product (e.g., pcb, substrate, flex board). The functional view of Devices which are fabricated as part of the interconnect product fabrication process ( e.g., printed inductors, printed connectors, printed capacitors) are included in the functional definition. Devices which are embedded are considered to be external to the interconnect product since they are not fabricated as part of the product and their shape does not directly contribute to the shape definition of the interconnect product. Configuration management information and design management information is provided.

**cc 7: Interconnect Physical Requirements**

This Data includes all information related to shape and position requirements. Trace, via and other passage spacing, keepin, keepout, etc. is included. Explicit allowed volumetric shape, required connection locations, material specifications, etc. are included. Those layout items whose placement is driven by thermal considerations or electromagnetic interference may be specified. Configuration management information and design management information is provided. This data includes at least one geometric representation.



**cc 8: Assembly Physical Design**

This data includes all data that defines the physical relationships between the components in the assembly. This data includes all the components that exist in the assembly, and specifies those that provide physical interfaces to the next level of assembly. Several types of assembly joint may be specified. Design re-use is explicitly supported with traceability. Complete traceability back to requirements is provided. This data identifies those components that do not meet design requirements. Appropriate elements of Geometric Dimensioning and Tolerancing are provided. This data includes both design view and usage view of the assembly. Configuration management information and design management information is provided. This data includes at least one geometric representation.

**cc 9: Interconnect Design**

This data provides functional and physical layout information sufficient to allow manufacture and test of an interconnect. Design re-use is explicitly supported with traceability. Complete traceability back to requirements is provided. Product connection requirements, shape requirements, product specifications, process specifications, material specifications including manufacturing view of stackup, Geometric Dimensioning and Tolerancing are provided. This data identifies those elements that do not meet design requirements. This data includes both design view and usage view of the interconnect product. Support for specification of signal prioritization is provided. Support for specifying the explicit network topology to be implemented is provided. Configuration management information and design management information is provided. This data includes at least one geometric representation.

**cc 10: Interconnect Design (Microwave)**

This data is similar to Class 9, with the exception that the metallization may be considered to be microstrip or stripline, with a specified shape element of the cross-section (i.e., point, edge, cutting plane) acting as the terminal (terminal pair, port) of the line or component. Use of formal external definitions is provided to link in models with the product definition data. Analytical model terminals may be distributed. This data identifies those elements that do not meet design requirements. This data includes both design view and usage view of the interconnect product. Support for specification of signal prioritization is provided. Support for specifying the explicit network topology to be implemented is provided. Configuration management information and design management information is provided. This data includes at least one geometric representation.

**cc 11: Geometric Dimensioning and Tolerancing**

This data includes the 14 geometric tolerances in ISO 1101. Angularity, circularity, circular run-out, concentricity, cylindricity, flatness, parallelism, perpendicularity, position, profile of any line, profile of any surface, straightness, symmetry, and total run-out. This data includes dimension, limits and fits. This data includes datum system definition. This data includes the tolerance zones in ISO 1101 and ASME Y14.5 (e.g., cylindrical, parallelepiped, projected, and conical). Configuration management information and design management information is provided.

**cc 12: Product Rule**

This data includes support for rule creation, management, assignment to product data or features, assignment to product or requirement parameters. Complete specification of this capability is deferred until the expression work integration is completed. Configuration management information and design management information is provided.

### **cc 13: Functional Decomposition**

This data includes specification of the folded and unfolded (elaborated) hierarchical product definition in the functional view. Support is provided for a usage view and a design view. The ability to exchange data defining a functional test bench and functional specification based on signals is included. Signal definition relies on external definition, but signal properties may be represented. Support is provided for both lumped element and distributed port properties. Analysis models may be included in the exchange structure with close integration accomplished by pin mapping. Configuration management information and design management information is provided.

### **cc 14: Package Functional and Physical Characterization**

Package Data includes following information: Case style, material identification, environmental constraints, performance data, simulation models. Formal encapsulation of external data type definitions is made for parametric data and analysis models. Terminal identification is provided to ensure consistency between device views. Package body material is included. Terminals may have core and surface materials. Shape, material, technology, tolerance on shape and on parameters, units are included. Shapes included may be categorized according to discipline (e.g, thermal analysis, vibration analysis), and analysis environment (e.g., assembly, end-user). Geometric Dimensioning and Tolerancing is included. Complex packages may be treated by the design owner as an interconnect product and publish the information in package as the customer view. Formal Reference information to a defining document is provided. Configuration management information and design management information is provided. This data includes at least one geometric representation.

### **cc 15: Geometrically Bounded Surface Model**

This class shall not be implemented by itself.

- The class requires the implementation of the following Units of Functionality:
- `geometrically_bounded_2d_wireframe`
- `non_topological_surface`

### **cc 16: Wireframe Model With Topology**

This class shall not be implemented by itself.

- The class requires the implementation of the following Units of Functionality:
- `wireframe_2d_model_with_topology`
- `wireframe_with_topology`

### **cc 17: Advanced Boundary Representation**

This class shall not be implemented by itself.

- The class requires the implementation of the following Units of Functionality:
- `advanced_boundary_representation`

### **cc 18: Constructive Solid Geometry**

This class shall not be implemented by itself.

- The class requires the implementation of the following Units of Functionality:
- `constructive_solid_geometry`

### **cc 19: Extruded Solid**

This class shall not be implemented by itself.

- The class requires the implementation of the following Units of Functionality:
- `solid_of_linear_extrusion`

**cc 20: Geometrically Bounded 2d Wireframe Model**

This class shall not be implemented by itself.

**cc 21: Wireframe 2d Model With Topology**

This class shall not be implemented by itself.

**cc 22: Curve 2d**

This class shall not be implemented by itself.

**cc 23: Basic Curve 2d**

Includes Only Lines, Circle and Arc Subtype of Conic. This class shall not be implemented by itself.

**cc 24: Laminate Assembly Design**

This data provides physical assembly information sufficient to allow communication of the arrangement of laminates in an interconnect product, and required interconnections among the materials assembled. Configuration management information and design management information is provided.

**cc 25: Connection Zone Based Model Extraction**

This data provides information sufficient to allow communication of the explicit geometric basis for connection points of analysis models. Configuration management information and design management information is provided.

**cc 26: Functional Specification**

This data provides information sufficient to allow communication of the behavioural specification of product functions. Formal encapsulation of external data type definitions is made for parametric data and signal characterization. Configuration management information and design management information is provided.

**cc 27: Physical Unit Physical Characterization**

Physical Unit Physical Characterization data includes following information: Material identification, environmental constraints, performance data, simulation models. Formal encapsulation of external data type definitions is made for parametric data and analysis models. Shape, material, technology, tolerance on shape and on parameters, units are included. Shapes included may be categorized according to discipline (e.g. thermal analysis, vibration analysis), and analysis environment (e.g., assembly, end-user). Geometric Dimensioning and Tolerancing is included. A Formal Reference capability to the defining document is provided. Configuration management information and design management information is provided. This data includes at least one geometric representation.

**cc 28: Packaged Part White Box Model**

Packaged Part White Box Model Data includes following information: device model, package data, functional data, environmental constraints, performance data, and simulation models. Assembly arrangement of devices included in the package to compose the packaged part is explicitly provided. Mapping of analysis model connection points to package terminals is provided. Formal encapsulation of external data type definitions is made for parametric data and analysis models. Pin mapping is provided to ensure consistency between device views. Shape, material, technology, tolerance on shape and on parameters, units are included. Shapes included may be categorized according to discipline (e.g. thermal analysis, vibration analysis), and analysis environment (e.g., design, assembly, end-user). Geometric Dimensioning and Tolerancing is included. The functional data includes two distinct data sets: hierarchical functional decomposition into behavioural elements embedded in a network represented at each level by a nodal formulation; collection of device terminals (e.g., connector terminals, printed circuit board interface areas, jumper ends) that implement the functionality of a network node. Configuration

management information and design management information is provided. This data includes at least one geometric representation.

#### **cc 29: Printed Part Functional and Physical Characterization**

Printed Part Data includes following information: device model, layout template data, functional data, environmental constraints, performance data, simulation models. Mapping of analysis model connection points to printed part terminals is provided. Formal encapsulation of external data type definitions is made for parametric data and analysis models. Pin mapping is provided to ensure consistency between device views. Shape, material, technology, tolerance on shape and on parameters, units are included. Shapes included may be categorized according to discipline (e.g. thermal analysis, vibration analysis), and analysis environment (e.g., design, assembly, end-user). Geometric Dimensioning and Tolerancing is included. The functional data includes two distinct data sets: hierarchical functional decomposition into behavioural elements embedded in a network represented at each level by a nodal formulation; collection of device terminals that implement the functionality of a network node. Configuration management information and design management information is provided. This data includes at least one geometric representation.

#### **cc 30: Open Shell Model**

This class shall not be implemented by itself.

- The class requires the implementation of the following AIM entities:
- manifold\_surface\_shape\_representation

### **2.6.8 AP212**

#### **Electrotechnical Design and Installation (ISO 10303-212:2001)**

This Part of ISO 10303 specifies information requirements for the exchange of design information of electrotechnical plants and industrial systems.

There is no restriction whether those systems are used to equip a building, a plant, or transportation systems like cars or ships. This covers equipment for power-transmission, power-distribution, and power-generation, electrical machinery, electric light and heat, control and automation systems.

This Application protocol includes the description of the data needed for design, installation and commissioning of electrotechnical plants, and for their representation in documents, as specified in IEC 1082: Preparation of documents used in electrotechnology. That includes the hierarchical structure of products and functions, their interrelations, their connectivity and their schematic representation.

#### **2.6.8.1 Scope**

The following are **within** the scope of this Part of ISO 10303.

- The data needed to describe an electrotechnical plant throughout the phases of design, installation and delivery although those data will be used throughout the life cycle of the product;
- Data needed to describe terminals and interfaces of electrotechnical products;
- Data needed to describe the functional decomposition of an electrotechnical product;
- Data needed to describe the cabling and harnesses of devices and equipment;
- Data needed to describe cable tracks and to give the required mounting instructions;
- Data needed for the reference designation of the design's building blocks;
- Data needed to specify the pieces of information exchanged between the various parts of the design;

- Objects to furnish the design with appropriate technical data;
- Data that are necessary for the tracking of a design's release;
- Data that are necessary to track the approval of a design or a design aspect.

### 2.6.8.2 Outside scope

The following are **outside** the scope of this Part of ISO 10303.

- Data describing design changes before the initial approval (e.g. design corrections from checking);
- The business data for the management of a design project (e.g. budget, schedule);
- Data needed for the simulation and testing of a design (e.g. test patterns, behavioural models);
- The mechanical design of electric/electronic products.

### 2.6.8.3 Conformance Classes

AP212 has 4 Conformance Classes, the conformance classes are characterized as follows:

#### cc 1: Configuration Controlled Design and Documentation

This conformance class supports the following areas:

- "classification and item designation;
- configuration controlled design
- documentation using two-dimensional schematic diagrams;
- product oriented connectivity;
- product structure;
- work flow related information.

**Note** - This conformance class describes the equipment used in an electrotechnical system and its documentation throughout all stages of the design of the system and its installation."

#### cc 2: Functional Aspects and Information Flow

This conformance class supports the following areas in addition to the content of CC1:

- "allocation of the functional aspects to the physical aspects of the design;
- functional aspects of the electrotechnical system;
- functional networks;
- information flow in the electrotechnical system.

**Note** - This conformance class describes the functional aspects of an electrotechnical system throughout all stages of the design of the system and its installation."

#### cc 3: Installation and Arrangement of Electrotechnical Equipment

This conformance class supports the following areas in addition to the content of CC1:

- "documentation using two-dimensional dimensioned drawings;
- information related to the arrangement and positioning of the equipment;
- installation of the system.

**Note** - This conformance class describes the spatial aspects of an electrotechnical system throughout all stages of the design of the system and its installation and its documentation."

#### **cc 4: Description of the Entire Electrotechnical System**

This conformance class supports the information content of cc 1 to cc 3.

**Note** - This conformance class provides information about all aspects of an electrotechnical systems throughout its design and installation.

### **2.6.9 AP214**

#### **Core Data for Automotive Mechanical Design Processes (ISO 10303-214:2001)**

"The AP Scope - the exchange of information between various applications which support the development process of a vehicle.

##### **2.6.9.1 Scope**

The following are **within** the scope of this part of ISO-10303:

- Products of automotive manufacturers and suppliers that include parts, assemblies of parts, tools, and assemblies of tools. The parts include the constituents of the car body, power train, chassis, and interior. (The tools include those specific to the product produced and used by various manufacturing technologies, such as shaping, transforming, separating, coating, or fitting; Typical technologies for primary shaping are molding or casting, for transforming are bending or stamping, for separating are milling or lathing, for coating are painting or surface coating, and for fitting are welding or riveting);
- Process plan information to manage the relationships among parts and the tools used to manufacture them and to manage the relationships between intermediate stages of parts or tools, referred to as in-process parts;
- Product definition data and configuration control data pertaining to the design phase of a product's development;
- Changes of a design, including tracking of the versions of a product and data related to the documentation of the change process;
- Management of alternate representations of parts and tools during the design phase;
- Identification of standard parts based on international, national, or industrial standards and library parts, based on company or project conventions.
- Release and approval data for various kinds of product data;
- Data that identify the supplier of a product and any related contract information;
- Any of eight types of representation of the shape of a part or tool:
  - a. 2D-wireframe representation;
  - b. 3D-wireframe representation;
  - c. geometrically bounded surface representation;
  - d. topologically bounded surface representation;
  - e. faceted-boundary representation;
  - f. boundary representation;
  - g. compound shape representation;
  - h. constructive solid geometry representation.
- Shape representation of parts or tools that is a mixture of the types of shape representation given above (hybrid model);
- Data that pertains to the presentation of the shape of the product;
- Representation of portions of the shape of a part or a tool by form features;
- Product documentation represented by explicit and associative draughting;
- References to product documentation represented in a form or format other than that specified by ISO 10303 (Other forms or formats may be physical clay models, digital data in other standard

formats such as NC-data according to ISO 6983, or text data according to ISO/IEC 8879 Standard Generalized Mark-up Language (SGML));

- The simulation data for the description of kinematic structures and configurations of discrete tasks;
- Kinematics simulation of a windshield wiper.
- Properties of parts or tools;
- Surface conditions;
- Tolerance data.

### **2.6.9.2 Outside scope**

The following are **outside** the scope of this part of ISO 10303:

- Product definition data pertaining to any life cycle phase of a product not related to design;
- Business or financial data for the management of a design project;
- A general parametric representation of the shape of the part or tool;
- Data describing the pneumatic, hydraulic, electric, or electronic functions of a product;
- Continuous kinematics simulations over time;
- Data describing the input or output of finite element analysis.

### **2.6.9.3 Conformance Classes**

AP214 has 20 Conformance Classes, the conformance classes are defined for the following application areas:

- conformance classes 1 to 5 for CAD/CAM;
- conformance classes 6 to 10 for product structure and configuration management;
- conformance classes 11 to 13 for process planning;
- conformance classes 14 and 15 for feature based design;
- conformance classes 16 and 17 for simulation and quality control;
- conformance classes 18 and 19 for configuration control of process planning with 3D digital mockup data exchange and sharing;
- conformance class 20 for complete data storage and retrieval.

The conformance classes are characterized as follows:

#### **cc 1: Component design with 3D shape representation**

This conformance class supports the following areas:

- component design of car body, power train, chassis, or interior parts;
- component design of tools.

This conformance class includes requirements that match those defined in the conformance classes 2, 4, 5, and 6 of ISO 10303--203, with the additional requirement for geometric presentation (P1), csg model (G7), and element structure (S2). In the area of configuration control information this conformance class requires product management data (S1), which is a subset of conformance class 1 of ISO 10303--203.

#### **cc 2: Assembly design with 3D shape representation**

This conformance class supports the following areas:

- conceptual design including assembly definitions;
- mountability examination;
- packaging layout.

This conformance class includes requirements that match those defined in the conformance classes 2, 4, 5, and 6 of ISO 10303--203, with the additional requirement for geometric presentation (P1), csg model (G7), element structure (S2), and external reference mechanism (E1). In the area of configuration control information this conformance class requires product management data (S1) and item definition structure (S3), which is a subset of conformance class 1 of ISO 10303-203.

### **cc 3: Component drawings with wireframe or surface shape representation**

This conformance class supports the following areas:

- component drawings or sketches for car body or some interior parts;
- component drawings or sketches for tools.

This conformance class includes requirements that match those defined in ISO 10303-201, with additional requirements for wireframe model 3d (G2) and connected surface model (G3).

### **cc 4: Assembly drawings with wireframe, surface or solid shape representation**

This conformance class is suitable for use in the following areas:

- component or assembly drawings for power train, chassis, or interior parts;
- component or assembly drawings for tools.

This conformance class includes requirements that match those defined in the conformance classes 3, 5, 7, 9, and 10 of ISO 10303--202, with the additional requirement for item definition structure (S3), external reference mechanism (E1), and csg model (G7).

This conformance class includes the requirements as defined for the conformance classes 2 and 3 of this part of ISO 10303.

### **cc 5: Styling data**

This conformance class is suitable for use in the following areas:

- digital mockup;
- styling.

### **cc 6: Product data management (PDM) without shape representation**

This conformance class is suitable for use in the following areas:

- product data management systems that manage CAD models as files;
- administrative data of parts, assemblies, documents, and models.

This conformance class includes requirements that match those defined in the conformance class 1 of ISO 10303--203.

### **cc 7: Product data management (PDM) with 3D shape representation**

This conformance class supports the following areas:

- administrative data of parts, assemblies, documents, and models;
- conceptual design including assembly definitions;
- mountability examination;
- packaging layout;
- data exchange between product data management systems linked to CAD/CAM systems.

This conformance class includes requirements that match those defined in the conformance classes 1, 2, 4, 5, and 6 of ISO 10303--203, with the additional requirement for geometric presentation (P1), csg model (G7), element structure (S2), and external reference mechanism (E1).

This conformance class includes the requirements as defined for the conformance classes 2 and 6 of this part of ISO 10303.



**cc 8: Configuration controlled design without shape representation**

This conformance class is suitable for use in the following areas:

- configuration control for power train, chassis, car body, or interior parts;
- configuration control for tools.

This conformance class includes the requirements as defined for the conformance class 6 of this part of ISO 10303, with the additional requirement for specification control (S7).

**cc 9: Configuration controlled design with 3D shape representation**

This conformance class supports the following areas:

- configuration control for power train, chassis, car body, or interior parts;
- configuration control for tools;
- administrative and configuration control data of parts, assemblies, documents, and models;
- product data management systems for control of a large number of product variants.

This conformance class includes requirements that match those defined in the conformance classes 1, 2, 4, 5, and 6 of ISO 10303--203, with the additional requirement for geometric presentation (P1), csg model (G7), element structure (S2), external reference mechanism (E1), and specification control (S7).

This conformance class includes the requirements as defined for the conformance classes 7 and 8 of this part of ISO 10303.

**cc 10: Configuration controlled design with shape representation and draughting data**

This conformance class supports the following areas:

- configuration control and assembly drawings for power train, chassis, car body, or interior parts;
- configuration control and assembly drawings for tools;
- administrative and configuration control data of parts, assemblies, documents, and models;
- product data management systems for control of a large number of product variants with links to CAD/CAM systems.

This conformance class includes the requirements as defined for the conformance classes 4 and 9 of this part of ISO 10303.

**cc 11: Process planning of components**

This conformance class supports process planning for components (piece parts) with shape and draughting data.

This conformance class includes the requirements as defined for the conformance class 1 of this part of ISO 10303, without the requirement for geometrically bounded surface model (G8), and the conformance class 3 of this part of ISO 10303, without the requirement for geometrically bounded surface model (G8), and the conformance class 3 of this part of ISO 10303.

**cc 12: Process planning of components with form feature and tolerance data**

This conformance class supports process planning data for components (piece parts) with shape, draughting, form feature, tolerance, and surface condition data.

This conformance class includes the requirements as defined for the conformance class 11 of this part of ISO 10303, with the additional requirement for user defined feature (FF1), pre defined feature (FF2), generative featured shape (FF3), surface condition (C1), dimension tolerance (T1), and geometric tolerance (T2).

**cc 13: Effectivity controlled process planning of assemblies**

This conformance class supports process planning with effectivity control for assemblies with shape, draughting, form feature, tolerance, and surface condition data.

This conformance class includes the requirements as defined for the conformance class 12 of this part of ISO 10303, with the additional requirement for item definition structure (S3) and effectivity (S4).

#### **cc 14: Feature based design**

This conformance class supports the following areas:

- feature based conceptual design for components and assemblies, including manufacturing information such as tolerance and surface condition data;
- feature based mountability examination.

This conformance class allows for identification of form features on the final shape of a component or of an assembly.

This conformance class includes requirements that match those defined in ISO 10303--224, with the additional requirement for geometric presentation (P1), wireframe model 3d (G2), connected surface model (G3), faceted b rep model (G4), csg model (G7), external reference mechanism (E1), and surface condition (C1).

This conformance class includes the requirements as defined for the conformance class 2 of this part of ISO 10303,

#### **cc 15: Feature based design with flexible feature placement**

This conformance class supports the following areas:

- feature based conceptual design for components and assemblies, supporting efficient design changes through flexible feature placement;
- feature based mountability examination.

This conformance class allows for an independent feature definition, e.g. in a feature library, and its usage through placement on the shape of a component or of an assembly.

This conformance class includes the requirements as defined for the conformance class 14 of this part of ISO 10303, with the additional requirement for generative featured shape (FF3).

#### **cc 16: Kinematic simulations for components and assemblies with 3D shape representation**

This conformance class supports the following areas:

- collision detection;
- support of kinematics modules of CAD systems.

This conformance class includes the requirements as defined for the conformance class 2 of this part of ISO 10303, without the requirement for geometrically bounded surface model (G8) and with the additional requirement for kinematics (K1) and item property (PR1).

#### **cc 17: Measured data**

This conformance class supports the following areas:

- exchange of scanned (measured) data from a measuring system to a CAD/CAM system;
- quality control.

**cc 18:** Configuration controlled process planning of components and assemblies with 3D shape representation and kinematic data

**cc 19:** Configuration controlled process planning of components and assemblies with 3D shape representation including form features and kinematic data

#### **cc 20: Data storage and retrieval systems**

This conformance class supports database implementations to store, retrieve, or archive all of the data specified in this part of ISO 10303. Data manipulation functionality as performed in application systems is not expected to be implemented within the scope of this conformance class.

This conformance class includes all requirements as defined for the conformance classes 1 to 19 of this part of ISO 10303.

#### **2.6.9.4 AP214 second edition**

The second edition of STEP AP214 was published in December 2003 by ISO. The document eliminates inconsistencies and minor errors detected during application of AP214. There was no change in scope or functionality compared with the first edition. As with the first edition, the standard is available in PDF and HTML format. A HTML version has also been created in which the changes are marked in color. Processing of the change requests and creation of the document was coordinated by the ProSTEP iViP “Maintenance” working group. The second edition, like all documents relating to standards, can be obtained from your relevant national standardization organization.

#### **2.6.9.5 AP214 third edition**

The main component of the next version is harmonization with the OMG specification PLM Services and the linking of the two standards. It was also decided that the HTML version will become the normative reference and that there will be no need for the PDF document in the future.

SC4 has launched activities dealing with the quality of product data. It is planned that an initial standard for the quality of 3D models be drawn up based on the SASIG Product Data Quality Guideline and thus on the VDA Recommendation 4955. Other product data quality standards will follow.

Electronic catalogs and reference libraries were further topics at the ISO meeting. SC4 is involved with the definition of the processes needed to maintain and publish related standards.

### **2.6.10 AP215**

#### **Ship arrangement (ISO 10303-215:2003)**

This part of ISO 10303 specifies the use of the integrated resources necessary for the scope and information requirements for the exchange of three-dimensional product definition data and its configuration status information for Naval and commercial ship arrangements. Configuration in this context pertains to data specific to revision tracking and change history of selected ship spatial entities within the Product model. The term exchange is used to narrow the scope to only those data that are transferred between enterprise systems. This is to distinguish it from a data model supporting distributed, multi-user database applications.

**NOTE** - The application activity model in annex F provides a graphical representation of the processes and information flows that are the basis for the definition of the scope of this part of ISO 10303.

#### **2.6.10.1 Scope**

The following are within the scope of this part of ISO 10303:

- data describing the general subdivision of a ship into spatially bounded regions;

- data identifying physical boundaries partitioning the ship into compartments suitable for the stowage of cargo, operation of machinery, and occupancy by crew and passengers;
- data identifying logical boundaries subdividing the ship into zones for the purpose of controlling access, designating design authority, or applying specific design requirements;
- data required for the definition of spatial boundaries based on references to moulded form regions or geometric surfaces;
- configuration management data for identification of versions of compartment designs and for management of changes to the design during the design life cycle phase;
- data identifying the intended functions of compartments and zones;
- data required for recording the volumetric capacities of cargo compartments at various combinations of vessel heel and vessel trim;
- data required for calculation of the magnitude and location of loads acting upon a ship's structural systems due to the weight of cargos contained in compartments;
- data required for the determination of adjacency of compartments;
- data identifying spaces related by common functional purpose, position within the ship, or connection by engineering systems;  
**EXAMPLE** - Port and starboard wing tank pairs are spaces related by position.
- data identifying dimensional aspects of spaces;
- data identifying the product structuring of engineering parts and structural parts contained within a space;
- data identifying the product structuring of compartments in an area the ship;
- data required for the definition of design requirements placed on a space by systems within the ship;
- data required for the identification of cargos, stores and consumables and allocation of those items to compartments and tanks for design analysis or on specific voyages during the operation of the ship;
- definition of loading conditions for analysis of the floating position of the ship under different cargo loading scenarios;
- data required for the analysis of stability of the ship after damage.  
**NOTE** - Annex L provides additional information pertaining to the industrial use of this part of ISO 10303.

### 2.6.10.2 Outside scope

The following are **outside** the scope of this part of ISO 10303:

- data defining the representation of moulded surfaces of structural or non-structural bulkheads;  
**NOTE** - Moulded forms are referenced by external instance references to 10303-216.
- data defining the representation of structural systems and parts.  
**NOTE** - Structural systems and parts are referenced by external instance references to 10303-218.

### 2.6.10.3 Conformance Classes

ISO/DIS 10303-215 has the following conformance classes:

- Class 1 is a conformance class to exchange early design data regarding ship arrangements;
- Class 2 is a conformance class to exchange detail design data regarding ship arrangements;
- Class 3 is a conformance class to exchange operational data regarding ship arrangements;
- Class 4 is a conformance class to exchange analysis data regarding ship arrangements.

Support for a particular conformance class requires support of all the options specified in that class. Conformance to a particular class requires that all of the AIM elements defined in Clause 6 as part of that class be supported.

## 2.6.11 AP216

### Ship moulded forms (ISO 10303-216:2004)

This part of ISO 10303 specifies the scope and information requirements for the exchange of ship moulded form definitions, geometric representations, and related hydrostatic properties.

**NOTE** - The application activity model in annex F provides a graphical representation of the processes and information flows which are the basis for the definition of the scope of this part of ISO 10303.

#### 2.6.11.1 Scope

The following are within the scope of this part of ISO 10303:

- definition of moulded form geometry related to commercial and naval ships;
- definition of moulded form geometry of the preliminary design, detailed design, and production stages of the life cycle of a ship;
- definition of moulded form geometry that describe the hull moulded form of the ship, including mono hullforms, multi-hullforms, the bulbous bow, transom stern, thruster tunnels, and additional appendages;  
**EXAMPLE** - Types of moulded form geometry are bilge keel, spray rails, shaft struts, and shaft bossings that are part of the final moulded form of the ship hull.
- definition of moulded form geometry that describe the moulded form of propellers and rudders;
- definition of moulded geometry that describe the moulded form of decks including camber and sheer;
- definition of moulded geometry of internal ship compartment boundaries and the moulded form geometry of ship structural and non-structural elements;  
**EXAMPLE** - Bulkheads, girders, and profiles are examples of moulded form geometry of ship structural elements.
- definition of general characteristics;  
**EXAMPLE** - Main dimensions, ship type, shipyard, ship owner, and classification data are examples of general characteristics.
- definition of design parameters for the ship hull, bulbous bow, propeller, rudder, and appendages that are necessary to describe the moulded form, and are required to calculate hydrostatic properties;
- definition of hydrostatic properties of the ship moulded form that depend on the draught of the ship;  
**EXAMPLE** - Displacement, centre of buoyancy, centre of flotation, metacentric height, and cross curves of stability are examples of hydrostatic properties.
- definition of global and local co-ordinate systems and spacing tables used in naval architecture for position purposes;
- shape definition of ship moulded forms that use one of the following specified types of geometric representation:
  - offset table representation;
  - wireframe representation;
  - surface representation.

- geometric representations containing geometric elements used in naval architecture;  
**EXAMPLE:** Waterlines and buttock lines are examples of geometric representations.
- version control and approval of moulded forms and related hydrostatics.

### 2.6.11.2 Outside scope

The following are **outside** the scope of this part of ISO 10303:

- product definition data related to hull plating defined on the moulded form;
- product definition data related to ship compartmentation and ship arrangements;  
**NOTE** - Reference ISO 10303-215
- product definition data related to ship structures and ship assemblies;  
**NOTE** - Reference ISO 10303-218
- product definition data related to ship machinery and ship superstructures;  
**NOTE** - Reference ISO 10303-226
- mechanical systems and material aspects of propellers, rudders and control surfaces;  
**NOTE** - Reference ISO 10303-226
- product definition data from the decommissioning stage of the ship life cycle;
- hydromechanic properties of the ship;  
**EXAMPLE** - Motion response and ship maneuvering are examples of hydromechanic properties.
- damage stability properties of ships;  
**NOTE** - Reference compartmentation damage stability properties of ISO 10303-215.
- ship longitudinal strength.

### 2.6.11.3 Conformance Classes

AP216 has the following conformance classes:

- Class 1 is a conformance class to exchange hydrostatic data;
- Class 2 is a conformance class to exchange moulded form geometry as an offset table;
- Class 3 is a conformance class to exchange moulded form geometry as a wireframe representation;
- Class 4 is a conformance class to exchange moulded form geometry as a surface representation;
- Class 5 is a conformance class to exchange moulded form geometry as a surface representation with hull applicability;

Conformance to a particular class requires that all of the AIM elements defined in Clause 6 as part of that class be supported.

## 2.6.12 AP218

### Ship structures (ISO10303-218:2004)

This part of ISO 10303 specifies the use of the integrated resources necessary for the scope and information requirements for the exchange of product definition data and its configuration and approval status information for ship structural systems. Configuration in this context pertains to data specific to revision tracking and change history of selected ship structural entities within the product model. Approval pertains to the company internal approval and the classification society approval. This Application Protocol supports the shipbuilding activities and applications associated with the design phase and the manufacturing phase.

### 2.6.12.1 Scope

The following are within the scope of this part of ISO 10303:

- product definition data pertaining to the ship's structure which includes hull structure, superstructure and all other internal structures of commercial and naval ships;
- product definition data pertaining to the ship's structure
- product definition data pertaining to the pre-design phase of the ship's structure;
- product definition data pertaining to the main design phase of the ship's structure;
- product definition data pertaining to the manufacturing phase of the ship's structure;
- product definition data pertaining to the product structuring of ships, including the structuring by system and by assemblies within the ship;
- product definition data identifying the ship's general characteristics which are relevant to the design of the ship's structure;  
**NOTE** - The general characteristics include ship's main dimensions, designations and principle characteristics, as well as the rules, regulations and standards applicable to the ship. It also includes lightships weight distribution and free-board characteristics for the purpose of design and design approvals.
- product definition data pertaining to the ship's global co-ordinate system, local co-ordinate systems and spacing grids, which are used for defining the geometry of the ship's structure;
- product definition data pertaining to the geometrical representation of the ship's structure parts and assemblies;
- product definition data pertaining to the hull plating and the stiffener profiles, and the definition of structural features, which comprise the ship's structure parts and assemblies, including functional descriptions;  
**EXAMPLES** - edge, corner and interior cut-outs are structural features.
- product definition data pertaining to the design of the welded connections and joints of ship's structure parts and assemblies, including edge preparations and weld type and size;
- product definition data pertaining to the specification of transverse cross-sections through the ship's structure for the purpose of approval of strength;
- product definition data pertaining to ship's design loads, including shear forces and bending moments acting on the ship's structure, for the purpose of determining the longitudinal strength of the ship;
- product definition data pertaining to the weights and centres of gravity of the ship's structure parts and assemblies;
- product definition data pertaining to the materials of ship's structure, required to manufacture the ship or a part of it;
- product definition data pertaining to the configuration management of the ship's structure, including approval, versioning and change administration;
- product definition data pertaining to external references, technical documentation and other supporting concepts which are necessary and pertinent to the design and manufacture of the ship's structure parts and assemblies.

### 2.6.12.2 Outside scope

The following are **outside** the scope of this part of ISO 10303:

- product definition data pertaining to the ship's structure at the operation and de-commissioning phases of the ship's life cycle;
- business data for the management of a ship development project, such as budgets, schedules and resource requirements;
- product definition data pertaining to the direct calculation of ship's structure in the design stage;

- product definition data pertaining to the coating of structural parts as well as the production tolerances;
- product definition data pertaining to the ship's subdivision;
- product definition data pertaining to the ship's distribution systems;  
**EXAMPLES** - The electrical, piping and HVAC systems
- product definition data pertaining to the ship's machinery and propulsion systems;
- product definition data pertaining to the ship's outfit and furnishing;
- product definition data pertaining to ship's hull structure parts which are manufactured by forging or casting.  
**EXAMPLES** - Stern frames, rudder horns and propeller shaft brackets

### 2.6.12.3 Conformance Classes

AP218 has the following conformance classes:

Each conformance class grouping has been further qualified by a specific geometry option, indicating that representations of the data that will be created with the given AIC geometry.

- Option A – Edge based wire frame representation
- Option B – Geometrically bounded wire frame representation
- Option C – Non-manifold surface shape representation
- Option D – Advanced boundary representation
- Option H – Hull Applicability

If a geometry option is not specified, it is assumed that either no representation is present or that it is defined implicitly by the optional parameters on design\_definition.

Classes 1 – 3: ship structures definition and approval data that is created at the preliminary design stage of a ship, has structural definitions and shape representations of this stage, shall be exchanged between the shipyard and the subcontractor; and, the early class approval data for the preliminary design of the ship, including the definition of hull cross sections, has class approvals with regard to the detailed design definitions, shall be exchanged between the subcontractor and shipyard, and between the shipyard and the classification society;

Class 1 has Option A

Class 2 has Option C

Class 3 has Options C & H

Classes 4 – 6: ship structures definition and approval data that is elaborated at the detailed design stage of a ship, under consideration of the production design of ship structures, shall be exchanged between the shipyard and the subcontractor;

Class 4 has Option D

Class 5 has Option C

Class 6 has Options C, D & H

Classes 7 – 13: ship structures definition and approval data that is completed at the product manufacturing stage of a ship, has manufacturing and welding definitions, shall be exchanged between the design department and the manufacturing department of the shipyard;

Class 7 has Option A

Class 8 has Options A & H

Class 9 has Options C



Class 10 has Options C & H  
Class 11 has Option B  
Class 12 has Option D  
Class 13 has Options D & H

Classes 14 – 15: class approval data for the structural parts (plates and profiles) of the ship, has class approvals with regard to the manufacturing definitions, shall be exchanged between the shipyard and the classification society.

Class 14 has Option C

Class 15 has Options C & H

Conformance to a particular class requires that all of the AIM elements defined in Clause 6 as part of that class be supported.

### **2.6.13 AP224**

#### **Mechanical Product Definition for Process Planning Using Machining Features (ISO 10303-224 (Ed 1):1999, ISO 10303-224 (Ed 3):2006)**

" This Part of ISO 10303 specifies the information needed to define product data necessary for manufacturing single piece mechanical parts. The product data is based on existing part designs that have their shapes represented by machining features. This part supports digital representation for computer integrated manufacturing.

##### **2.6.13.1 Scope**

The following are **within** the scope of this Part of ISO 10303:

- A single mechanical part manufactured by machining processes;
- Products that are to be manufactured by either milling or turning processes;
- Machining features for defining shapes necessary for manufacturing (Note: The machining feature set is defined in this part of ISO 10303);
- Machining features definition items necessary for creating machining form features;
- Customer order administrative data to track receipt of an order for a part to the shop floor, but not including tracking of the order on the shop floor;
- Approval data to authorize the manufacture of a part;
- Requisition administrative data to identify requirements and track the status of materials and equipment needed to manufacture a part;
- Identification of the status of a part work order;
- Track the state of raw stock for documenting the manufacturing history of a part;
- Track the design exception notice of a part (NOTE: The design exception notice relates to discrepancies in the machining features used to describe a part's shape);

##### **2.6.13.2 Outside scope**

The following are **outside** the scope of this Part of ISO 10303:

- Results from process planning;
- Representation of assemblies;
- Representation of composite material parts;

- Representation of sheet metal parts;
- Representation of part pedigree;
- Design features of a part;
- Schedule for completing a work order through the manufacturing process;
- Configuration control."

### **2.6.13.3 Conformance Classes**

AP224 has a single Conformance Class: Feature based process planning and shape represented by advanced B-Rep.

### **2.6.13.4 AP224 Edition 2 (ISO 10303-224 (Ed 2):2001**

The scope is extended to address the Representation of Manufactured Assemblies.

The content of AP224 is expanded to include:

- several new machining features (cutout, recess, rib top, and shape profile),
- the enhancement of several existing machining features (planar face, n-gon profile, n-gon base shape, and the addition of a rectangular boss subtype),
- the ability to group features.

Features, dimensions, and tolerances are harmonized with AP214.

### **2.6.13.5 AP224 Edition 3 (ISO 10303-224 (Ed 3):2006**

Expand the scope of AP224 to include Gears.

## **2.6.14 AP225**

### **Building Elements Using Explicit Shape Representation (ISO 10303-225:1999)**

"This part of ISO 10303 specifies the building element shape, property, and spatial arrangement information requirements for building elements. Such information can be used at all stages of the life cycle of a building, including the design process, construction, and maintenance; the purpose is to enable software application systems in all building and construction industry sectors to exchange building element shape, property, and spatial arrangement information. Building element shape, property, and spatial arrangement information requirements specified in this part support the following activities:

- concurrent design processes or building design iterations;
- integration of building structure designs with building systems designs to enable design analysis;
- building design visualization;
- specifications for construction and maintenance; and
- analysis and review. (e.g., A design analysis function combines the building structure design with building service systems designs (for systems such as heating, ventilation, and air conditioning (HVAC) and piping) to check for physical clashes of the building structural elements with piping or air conditioning elements.

### 2.6.14.1 Scope

The following are **within** the scope of this part of ISO 10303:

- Explicit representation of the 3D shape of building elements (The shape of the building elements are represented explicitly using boundary representation (B-rep) solid models, swept solid models, and constructive solid geometry (CSG) models.);
- The spatial arrangement of building elements that comprise the assembled building;
- Building structures that represent physically distinct buildings that are part of a single building complex;
- Non-structural elements that enclose a building or separate areas within a building;
- The shape and arrangement of equipment and service elements that provide services to a building;
- The shape and arrangement of fixtures in a building;
- Service elements include items such as plumbing, ductwork, and conduits. Equipment includes items such as compressors, furnaces, or water heaters.
- Fixtures include items such as furniture and installed items like doorknobs.
- Specification of spaces and levels (Spaces include rooms, accesses, and hallways. Levels include concepts such as floors and mezzanines of a building);
- The shape of the site on which the building will be erected;
- Specification of properties of building elements, including material composition;
- Specification of classification information (Elements may be classified for reasons which include cost analysis, acoustics, or safety);
- Association of properties and classification information to building elements;
- Changes to building element shape, property, and spatial arrangement information;
- Association of approvals with building element shape, property, and spatial arrangement information;
- As-built record of the building.

### 2.6.14.2 Outside scope

The following are **outside** the scope of this part of ISO 10303:

- 2D shape representation and draughting presentation;
- The contents of building standards;
- Implicit representation of building elements through selection of standard parameters;
- Structural analysis of building structures, including loads, connections, and material properties required for analysis;
- Thermal analysis of buildings;
- The assembly process, joining methods, and detailed connectivity of building elements;
- Building maintenance history, requirements, and instructions;
- Approval, revision, versioning, and design change histories;
- Building elements without explicit shape representation;
- Bills of quantities (Note: In industries other than AEC, bills of quantities are often referred to as bills of material)."

### 2.6.14.3 Conformance Classes

AP225 has 14 Conformance Classes:

The three identified levels of geometric complexity are defined as follows:

- Faceted - geometric representations composed of lines and planes
- Elementary - geometric representations composed of faceted elements and the following curves and surfaces: circles, ellipses, hyperbolas, parabolas, b-spline curves, conical surface, cylindrical surface, spherical surface, and toroidal surface
- Advanced - geometric representation composed of elementary elements and b-spline surfaces

The conformance classes are characterized as follows:

**cc 1:** Building element and component property, classification, identification, and administration information; building composition and building element spatial arrangement; single level assemblies; and building element and component shape using faceted geometric shape representations.

**cc 2:** Building element and component property, classification, identification, and administration information; building composition and building element spatial arrangement; single level assemblies; and building element and component shape using faceted shape representations.

**Note** - The term "geometric shape representation encompasses both geometric sets and b-reps. Omission of the word "geometric" implies that in addition to geometric sets and b-reps, CSG representations are also included.

**cc 3:** Building element and component property, classification, identification, and administration information; building composition and building element spatial arrangement; single level assemblies; building site shape; and building element and component shape using faceted and elementary geometric shape representations.

**cc 4:** Building element and component property, classification, identification, and administration information; building composition and building element spatial arrangement; single level assemblies; building site shape; and building element and component shape using faceted and elementary shape representations.

**cc 5:** Building element and component property, classification, identification, and administration information; building composition and building element spatial arrangement; single level assemblies; building site shape; and building element and component shape using faceted, elementary, and advanced geometric shape representations.

**cc 6:** Same as cc 1 except that it includes multi-level assemblies.

**cc 7:** Same as cc 2 except that it includes multi-level assemblies.

**cc 8:** Same as cc 3 except that it includes multi-level assemblies.

**cc 9:** Same as cc 4 except that it includes multi-level assemblies.

**cc 10:** Same as cc 5 except that it includes multi-level assemblies.

**cc 11:** Building composition and arrangement of spaces; spaces and space property, classification, identification, and administrative information; and space shape using faceted and ground face space representations.

**cc 12:** Building composition and arrangement of spaces; spaces and space property, classification, identification, and administrative information; and space shape using faceted, ground face, and elementary space representations.

**cc 13:** Building composition and arrangement of spaces; spaces and space property, classification, identification, and administrative information; and space shape using faceted, ground face, elementary, and advanced space representations.

**cc 14:** Building complex and surrounding grounds shape and position.

## **2.6.15 AP227**

### **Plant Spatial Configuration (ISO 10303-227 (Ed 1):2001)**

This part of ISO 10303 specifies the use of the integrated resources necessary for the exchange of spatial configuration information of process plants. The spatial configuration information includes the shape, spatial arrangement, and other characteristics of the plant piping systems.

Components of the plant piping system include pipes, fittings, pipe supports, valves, in-line equipment, and instruments. Shape and spatial arrangement information for equipment and non-piping plant systems are also included. The primary life cycle phase intended for this AP is design. Other life cycle phases that can make beneficial use of this data include fabrication, installation, and maintenance of plant piping systems.

#### **2.6.15.1 Scope**

The following are within the scope of this part of ISO 10303:

- The shape and spatial arrangement of plant systems within the process plant;
- Explicit representation of the 3D shape of plant piping systems;
- Explicit representation of the 3D external shape of plant piping system components and equipment (The representation may include envelope, outline and detailed representations as well as a parametric representation of the external shape);
- The logical configuration of the plant piping system and the relationship of the logical configuration to the planned physical piping system design;
- Basic engineering data as needed for spatial layout and configuration of the plant piping system;
- References to functional requirements of the plant piping system, such as stream data and operational characteristics;
- References to or designation of functional characteristics of piping components and connected equipment;
- The identification, shape, location, and orientation of reserved areas, volumes, and space-occupying elements of a plant that are not part of heating, ventilation, and air conditioning (HVAC), piping, structural, electrical, or instrumentation and controls systems;
- References to specifications, standards, guidelines, or regulations, for the plant piping systems, components, or connected equipment that may specify physical characteristics of the system or component;
- Status of spatial arrangement of piping components, piping components, and connected equipment;

- Connections and connection requirements for piping components and equipment;
- Definition of piping component design data sufficient for the acquisition of the components;
- Change request, approval, notification, verification, tracking of differences between versions of piping system design information, tracking of changes to plant items and attributes of plant items;
- Specification of the chemical composition of the streams carried by the plant piping systems in sufficient detail to evaluate the suitability of piping components for the desired process.

### 2.6.15.2 Outside scope

The following are **outside** the scope of this part of ISO 10303:

- 2D schematic representations;
- The contents of specifications, standards, guidelines, or regulations;
- Information required for the assembly and erection of non-piping plant systems or the manufacture of components of these systems;
- Specification of the chemical composition of the streams carried by the plant piping system in sufficient detail for process flow design;
- Process design;
- Plant operating procedures;
- Commercial aspects of procurement procedures;
- Internal design of equipment.

### 2.6.15.3 Conformance Classes

AP227 (Ed 1) has 4 Conformance Classes:

The conformance classes are characterized as follows:

#### **cc 1: Piping System Functional Information**

"This conformance class provides piping system functional information. This conformance class contains functional information of the piping system and catalogue reference information, but no shape or spatial information. This conformance class enables ... exchange of functional information on plant piping systems. (The purpose of this conformance class is to provide an interface with ISO 10303 - 221 and piping functional design and schematics software.)"

#### **cc 2: Equipment and Component Spatial Information**

"This conformance class provides equipment and component spatial information. This conformance class contains basic equipment performance characteristics, connector location and orientation information, material specifications, version information, explicit shape, and catalogue reference information. This conformance class enables the exchange of minimal vendor equipment and component information."

#### **cc 3: Plant Layout and Piping Design Information**

"This conformance class provides plant layout and piping design information. This conformance class contains design, layout, and spatial information for the plant, and catalogue reference information. This conformance class enables the exchange of plant layout and piping design information for the following activities:

- Area classification;
- Space analysis;
- Plant arrangement (placement of space occupying elements);

- Spatial design of piping systems including pipe routing and component placement and placement of pipe supports;
- Operation and maintenance analysis;
- Constructability reviews;
- Interference checking;
- Development of equipment list and line list;
- Development of equipment takeoffs;
- Development of material takeoffs for piping and piping components;
- Connectivity and topology checks;
- Material and connection compatibility checks;
- Provision of spatial design information to support fabrication and construction;
- Spool and weld identification;
- Plant startup;
- Plant commissioning;
- Plant operation;
- Configuration management of plant items and piping system information.

Although not explicitly cited above, this conformance class also supports the activities listed for the other conformance classes."

**cc 4: Piping Fabrication and Installation Information**

"This conformance class provides piping fabrication and installation information. This conformance class contains system, plant item, and line identification, piping information, plant item characteristics and shape, and catalogue reference information. This conformance class enables the exchange of piping fabrication and installation information."

All four conformance classes include information concerning plant item characterization, piping component characterization, connectors, connections, and change information.

**2.6.15.4 AP227 – Second edition**

**Plant Spatial Configuration (ISO 10303-227 (Ed 2):2005)**

**Edition 2** of ISO 10303-227 is being balloted as a Committee Draft (CD) from 30 November 2001 to 28 February 2002. It includes ship piping and HVAC, and it replaces AP217.

The Scope of Edition 2 of ISO 10303-227 specifies the use of the integrated resources necessary for the scope and information requirements for the exchange of spatial configuration information of process plants, plant systems and ship systems. The spatial configuration information focuses on the shape and spatial arrangement of the components of the systems. The spatial configuration information principally supports the engineering, fabrication and installation life-cycle phases, but may be useful in the downstream life-cycle phases of operations and maintenance. This part accommodates the disciplines of plant design, system design, fabrication, inspection, installation and construction.

**2.6.15.4.1 Scope**

The following additional items are have been added to the scope of Edition 2 of ISO 10303-227:

- the shape and spatial arrangement of items in systems within a process plant or ship;

- information required for the design, analysis, fabrication and installation of piping components and piping systems;
- information on the inspection of fabricated piping; (NOTE: The functional configuration entails connectivity, sequencing, component size, and schedule, and may include other information, such as equipment tag numbers and requirements to perform consistency checks between the functional and physical representations of the design.)
- the identification of catalogue information associated with a component;
- the identification of catalogues that contain component definitions;
- status of components and connected equipment and of their spatial arrangement;
- data exchange;
- external reference to classification systems;
- external reference to standard parts;
- external reference to representations of standard parts.

#### 2.6.15.4.2 Outside scope

The following additional items are **outside** the scope of Edition 2 of ISO 10303-227:

- preparation of piping specifications;
- logistics and materials management;
- process design and conceptual engineering (e.g., process material and heat balances, process flow diagram development, and determination of equipment sizes);
- testing, commissioning, handover, maintenance, and disposal of a plant;
- information necessary to manage the evolution and growth of data sets through the life-cycle of a product or project other than indications of changes and approvals;
- history data;
- internal design and maintenance of equipment.

#### 2.6.15.4.3 Conformance Classes

**Edition 2** of ISO 10303-227 has added five (5) conformance classes grouped as follows:

**Conformance class 1** - Piping system functional information (Same as Edition 1);

**Conformance class 2** - Equipment and component spatial information (Same as Edition 1);

**Conformance class 3** - Plant layout and piping design information (Same as Edition 1);

**Conformance class 4** - Piping fabrication and installation information (Same as Edition 1);

**Conformance class 5** - Piping inspection information (New)

This conformance class provides piping inspection information in addition to the piping fabrication and installation information provided in conformance class 4. This conformance class contains system, plant item, and line identification, piping information, plant item characteristics and shape, catalogue reference information, and piping inspection information. This conformance class enables the exchange of piping inspection information in addition to piping fabrication and installation information.

**Conformance class 6** - HVAC system functional information (New)

This conformance class provides HVAC system functional information. This conformance class contains functional information of the HVAC system and catalogue reference information, but no



shape or spatial information. This conformance class enables the exchange of functional information on heating, ventilation, and air-conditioning (HVAC) systems.

**Conformance class 7 - HVAC spatial information (New)**

This conformance class provides HVAC layout and design information. This conformance class contains design, layout, and spatial information for the HVAC systems within the plant, and catalogue reference information. This conformance class enables the exchange of HVAC layout and design information and supports the following activities:

- area classification;
- space analysis;
- plant arrangement (placement of space occupying elements);
- spatial design of HVAC systems including component placement;
- HVAC operation and maintenance analysis;
- HVAC constructability reviews;
- interference checking;
- development of HVAC equipment list and line list;
- development of HVAC equipment takeoffs;
- development of material takeoffs for HVAC and HVAC components;
- connectivity and topology checks;
- material and connection compatibility checks;
- provision of spatial design information to support HVAC fabrication and construction.

**Conformance class 8 - Cableway spatial information (New)**

This conformance class provides cableway spatial information. This conformance class contains layout and spatial information for the cableway systems within the plant. This conformance class enables the exchange of cableway layout and spatial information, but does not provide the details of the cableway contents or the operating characteristics. Details of cableway contents or operating are beyond the scope of this edition of ISO 10303-227.

**Conformance class 9 - Piping and HVAC analysis information (New)**

This conformance class provides piping and HVAC analysis information. It enables the exchange of sufficient information about a piping or HVAC system for the performance of stress or flow analysis on the receiving system. It does not, however, include exchange of the results of such an analysis.

**Options within a conformance class (New)**

Several conformance classes have several shape representation options to allow for various geometric representations.

- Option A in any conformance class provides for the exchange of Brep shape representation
- Option B in any conformance class provides for the exchange of Pure CSG shape representation. This includes only primitive CSG solids, excluding swept, extruded, or Brep solids
- Option C in any conformance class provides for the exchange of Hybrid CSG shape representations. These include all CSG solids and Brep solids

The units of functionality for site\_characterization and change information are also included as optional within each conformance class.

- Site\_characterization, in particular, allows the file to be specified as applying to a "ship" rather than to a traditional "process plant"
- Change information allows revision history to be optionally included in an ISO 10303-227 file for any conformance class

## 2.6.16 AP232

### Technical Data Packaging Core Information and Exchange (ISO 10303-232:2002)

This part of ISO 10303 specifies the integrated resources necessary for the scope and information requirements for Technical Data Packages (TDPs) to be exchanged among product data management systems.

Each enterprise uses content, format, and the level of configuration control as parameters when establishing its product exchange or access requirements among business partners. Because of the diverse set of products, product data, and lifecycle processes PDM systems support, this part of ISO 10303 allows many combinations of these parameters.

Using a defined set of these parameters, the disclosure of product information needs to be sufficient to satisfy the business purpose of the TDP.

**NOTE 1** TDPs may be prepared to a level where the product information is sufficient to evaluate a product definition concept. Or a TDP may be prepared to a level where the product information is sufficient to enable full design disclosure.

Requirements for this part of ISO 10303 were derived from functions that create and use TDPs and reside throughout the product's life cycle. The key informational aspects addressed in this part of ISO 10303 are shared and exchanged throughout the product's life cycle.

**NOTE 2** Within a product's life cycle, there are many functions that create and use the technical information about a product. Figure 3 illustrates the functional usage of technical data within each life cycle phase of a product. The largest percentage of the technical data is developed in the concept development, concept and validation, and product and process development lifecycle phases. The operations and support lifecycle phase, for most products or commodities, is the longest and is impacted the greatest by the quality and usability of the TDP information. The production lifecycle phase typically has the second largest usage of the information contained within the TDP. In the production and product process development lifecycle phase, TDP data is used to build and deliver the product.

**NOTE 3** The application activity model in annex F provides a graphical representation of the processes and information flows that are the basis for the definition of the scope of this part of ISO 10303.

**EXAMPLE 1** The following represent different types of Technical Data Packages through a product's life cycle:

- Conceptual Design Drawings and Associated Lists;
- Developmental Design Drawings and Associated Lists;
- Product Drawings and Associated Lists;
- Commercial Drawings and Associated Lists;
- Special Inspection Equipment Drawings and Associated Lists;
- Special Tooling Drawings and Associated Lists.

**NOTE 4** Definitions for the preceding types of TDPs are given in .

The content, form, and format of the data are critical to the core information content for exchange or access of the TDP.

### 2.6.16.1.1 Scope

The following are within the scope of this part of ISO 10303:

- All products and their commodity types;  
**NOTE 5** This part of ISO 10303 is defined independently of product or commodity.
- Product definition data and product configuration control data pertaining to the concept development, concept and validation, product and process development, production, operations and support, and retirement phases of a product (herein called the product life cycle);  
**NOTE 6** ISO 10303 standards are referenced throughout the documentation of the requirements of this part of ISO 10303. This part utilizes ISO 10303 standards through the use of application interpreted constructs.
- Relationship of the product to a technical data package element, see ;
- Identification of drawings related to the product that require configuration control, exchange, or access;  
**NOTE 7** ISO 10303-201 and ISO 10303-202 are referenced throughout the documentation of the requirements of this part of ISO 10303. This part utilizes ISO 10303-201 and ISO 10303-202 through use of application interpreted constructs for drawings.
- The data content requirements for parts lists, data lists, index lists, indented data lists, and other associated lists that are associated to a drawing or a product data set, according to 3.5;
- The data content requirements for product data set that represent geometric product shape;
- Identification of alternate geometric representations of the product definition data by different disciplines during the product life cycle;  
**NOTE 8** Alternate geometric representations are defined in ISO 10303-201, ISO 10303-202, ISO 10303-203, ISO 10303-209, and other parts of ISO 10303.
- Identification of any group of technical data related to the product that needs configuration control exchange or access;  
**EXAMPLE 2** A finite element analysis (models, controls, and results) is a group of technical data.  
**EXAMPLE 3** Testing reports is a group of technical data.
- Identification of specifications and standards that define or describe the product or product unique processes;
- Identification of documentation that define or describe change activity to the product or product related documentation;  
**EXAMPLE 4** Change activity is documented in the form of Drawing Revision Notices, Engineering Change Notices, and Drawing Change Notices.  
**NOTE 9** ISO 10303-208 identifies exchange and access requirements for the life cycle change information.
- The Identification of standard parts (see ) for the purpose of their inclusion in a product's design;
- The visual presentation for human understanding of the associated list data and the product data set;  
**NOTE 10** Visual presentation can be for data content defined within this part of ISO 10303 or for additional data that is not explicitly specified in this part of ISO 10303.  
**NOTE 11** ISO 8879 Standard Generalized Markup Language (SGML), ISO 10744 HyTime, and ISO 10179 Document Style Semantics and Specification Language, satisfy presentation of associated lists with relationships into this part of ISO 10303.
- The data requirements for configuration control exchange of Technical Data Packages;  
**NOTE 12** Identification of document version will be defined by this part of ISO 10303.
- The identification and relationship of Technical Data Package elements within a TDP exchange;
- The identification of file and file format for Technical Data Package elements;  
**NOTE 13** File and file format information may be defined by this part of ISO 10303, another part of ISO 10303, National Standards or through mutual agreement between the sending and receiving parties of the TDP elements.

- The identification of digital and non-digital media for specific technical data package elements.  
**EXAMPLE 5** Digital media is floppy disk, diskette, compact disk, and 9-track tape.  
**EXAMPLE 6** Non-digital media is paper, mylar, aperture card, and vellum.

### 2.6.16.1.2 Conformance Classes

The following are outside the scope of this part of ISO 10303:

- Data content requirements for technological data used in, or resulting from, the analysis or test of a design that is used as evidence for consideration of a change to a design;  
**NOTE 14** A product data set may contain analysis or test data in a format other than this part of ISO 10303.
- Data content requirements for technological data that results in changes to the design during the initial design evolution prior to release;  
**NOTE 15** Changes prior to release are considered informal change activity.  
**NOTE 16** ISO 10303-209 defines requirements for informal change activity prior to engineering release.
- Data content requirements for business management data for a design project;  
**EXAMPLE 7** Business data is schedule, cost, time standards, risk, and related management information.
- Data content requirements for alternate representations of the data by different disciplines outside of that required to define, manufacture, or procure the product;
- Data content requirements for definition of digital or non-digital media for a TDP exchange;
- Data content requirements for definition of procedures to record the digital TDP files to digital media.

### 2.6.16.2 Conformance Classes

**AP232 has 14 Conformance Classes:**

The conformance classes are characterized as follows:

- cc 1: Data definition exchange (DDE) for files;
  - cc 2: Data definition exchange (DDE) for TDP elements;
  - cc 3: Data definition exchange (DDE) for indentured methods;
  - cc 4: Parts list (PL);
  - cc 5: Data list (DL);
  - cc 6: Indentured data list (IDL);
  - cc 7: Index list (IL);
  - cc 8: Other list (OL);
  - cc 9: List with presentation (cc 9 shall be implemented with one or more of cc 1 - 8.);
  - cc 10: Reference document identification and drawing identification;
  - cc 11: Reference document identification and drawing identification with ISO 10303-201 and ISO 10303-202 drawing presentation identification;
  - cc 12: Product data set (PDS) without presentation format (includes 3D models with surfaces and solids);
  - cc 13: Product data set (PDS) with shading (includes conformance class 12 and shading information);
  - cc 14: Product data set (PDS) with presentation format (includes cc 13, tolerances, annotation, and presentation information for human readability).
- cc 11 combines conformance class 10 with the drawing structure and administration capability found in ISO 10303-505.

cc 14 combines the capability of product shape geometry with presentation annotation and tolerances

**NOTE:** AP232 contains the PDM Schema as a proper subset.

## **2.6.17 AP239**

### **Product life cycle support (PLCS) (ISO/AWI 10303-239)**

The Product Life Cycle Core AP will provide a framework for integrating, exchanging and managing the technical data required to maintain a complex, and changing product over its life cycle.

The Product Life Cycle Core is the first in a series of ISO Specifications planned by PLCS, Inc. which together will provide an integration and exchange capability for product life cycle support data.

The Core will provide a comprehensive configuration definition for the products needing support, down to the level of a serialised product instance. The Core can also be used to identify, integrate, navigate, approve and control the effectivity of a wide range of related information required to deliver product life cycle support.

#### **2.6.17.1.1 Scope**

The following are within the scope of this part of ISO 10303:

- information for defining a complex product and its support solution;
- information required to maintain a complex product;
- information required for through life configuration change management of a product and its support solution;
- the representation of product assemblies including:
- the identification and representation of parts, their versions, definitions, and documentation and management information, such as dates and approvals assigned to parts;
- the representation of multiple product structure views and product breakdowns;
- the representation of the shape of an assembly as the composition of the shape representation of its components;
- the identification of positions within an assembly of parts to which component parts may be attached;
- the association of valued properties to a part or to an assembly;
- the representation of interfaces between products;
- the classification of parts, documents and assemblies.
- the representation of a product through life including:
- the representation of product requirements and their fulfilment;
- the representation of existing or potential future products;
- the identification of the configuration of a product for a given role;
- the specification of effectivity constraints applied to configuration of a product;
- the representation of predicted and observed states of products.
- the specification and planning of activities for a product including:
- the specification of tasks to be performed on a product;
- the representation of conditions for performing the tasks, including the resources required and the location of the resources and product;
- the representation of the type of person and skills required for performing a task;

- the representation of planning and scheduling of the tasks and the management and authorization of the subsequent work.
- the representation of the activity history of a product including:
  - the recording of the usage of a product and the resource usage;
  - the recording of the activities performed on a product and the resource usage.
- the representation of the product history including:
  - a historical record of the states of a product;
  - a historical record of the configuration status of the product;
- the location of product data;
- the observation of product data.

### 2.6.17.1.2 Outside scope

The following are outside the scope of this part of ISO 10303:

- the representation of business transactions for ordering, supplying or returning products and other resources needed for product support;
- the representation of business transactions concerning the transportation, shipment and receipt of products and other resources needed for product support.

### 2.6.17.2 Conformance Classes

This part of ISO 10303 provides for only one option that may be supported by an implementation:  
CC1: Product Life Cycle Support.

This option shall be supported by a single class of conformance that consists of all the ARM elements defined in the AP module (ISO 10303-439).

Conformance to a particular class requires that all ARM elements defined as part of that class be supported.

The conformance class, **Product Life Cycle Support** has been declared against the module: AP239 product life cycle support (ISO 10303-439).

**NOTE** - Conformance to Product Life Cycle Support requires that all ARM and MIM elements defined in the AP module (ISO 10303-439) be supported.

The scope of the **Product Life Cycle Support** conformance class is:

- information for defining a complex product and its support solution;
- information required to maintain a complex product;
- information required for through life configuration change management of a product and its support solution;
- the representation of product assemblies including:
  - the identification and representation of parts, their versions, definitions, and documentation and management information, such as dates and approvals assigned to parts;
- the representation of multiple product structure views and product breakdowns;
- the representation of the shape of an assembly as the composition of the shape representation of its components;
- the identification of positions within an assembly of parts to which component parts may be attached;

- the association of valued properties to a part or to an assembly;
- the representation of interfaces between products;
- the classification of parts, documents and assemblies.
- the representation of a product through life including:
- the representation of product requirements and their fulfillment;
- the representation of existing or potential future products;
- the identification of the configuration of a product for a given role;
- the specification of effectivity constraints applied to configuration of a product;
- the representation of predicted and observed states of products.
- the specification and planning of activities for a product including:
- the specification of tasks to be performed on a product;
- the representation of conditions for performing the tasks, including the resources required and the location of the resources and product;
- the representation of the type of person and skills required for performing a task;
- the representation of planning and scheduling of the tasks and the management and authorization of the subsequent work.
- the representation of the activity history of a product including:
- the recording of the usage of a product and the resource usage;
- the recording of the activities performed on a product and the resource usage.
- the representation of the product history including:
- a historical record of the states of a product;
- a historical record of the configuration status of the product;
- the location of product data;
- the observation of product data.

### 2.6.17.2.1 Modules

**Table 9 — AP239 modules**

<b>Application module</b>	<b>Application module</b>	<b>Application module</b>
ISO/TS 10303-1004	ISO/TS 10303-1106	ISO/TS 10303-1266
ISO/TS 10303-1006	ISO/TS 10303-1113	ISO/TS 10303-1267
ISO/TS 10303-1010	ISO/TS 10303-1114	ISO/TS 10303-1268
ISO/TS 10303-1010	ISO/TS 10303-1118	ISO/TS 10303-1269
ISO/TS 10303-1011	ISO/TS 10303-1121	ISO/TS 10303-1270
ISO/TS 10303-1012	ISO/TS 10303-1122	ISO/TS 10303-1271
ISO/TS 10303-1013	ISO/TS 10303-1123	ISO/TS 10303-1272
ISO/TS 10303-1014	ISO/TS 10303-1124	ISO/TS 10303-1273
ISO/TS 10303-1015	ISO/TS 10303-1126	ISO/TS 10303-1274
ISO/TS 10303-1016	ISO/TS 10303-1127	ISO/TS 10303-1275
ISO/TS 10303-1017	ISO/TS 10303-1128	ISO/TS 10303-1276
ISO/TS 10303-1018	ISO/TS 10303-1133	ISO/TS 10303-1277
ISO/TS 10303-1019	ISO/TS 10303-1134	ISO/TS 10303-1278
ISO/TS 10303-1020	ISO/TS 10303-1140	ISO/TS 10303-1280
ISO/TS 10303-1021	ISO/TS 10303-1141	ISO/TS 10303-1281
ISO/TS 10303-1022	ISO/TS 10303-1142	ISO/TS 10303-1282
ISO/TS 10303-1023	ISO/TS 10303-1164	ISO/TS 10303-1283
ISO/TS 10303-1024	ISO/TS 10303-1210	ISO/TS 10303-1285
ISO/TS 10303-1025	ISO/TS 10303-1214	ISO/TS 10303-1286

<b>Application module</b>	<b>Application module</b>	<b>Application module</b>
ISO/TS 10303-1026	ISO/TS 10303-1215	ISO/TS 10303-1287
ISO/TS 10303-1027	ISO/TS 10303-1216	ISO/TS 10303-1288
ISO/TS 10303-1030	ISO/TS 10303-1217	ISO/TS 10303-1289
ISO/TS 10303-1032	ISO/TS 10303-1218	ISO/TS 10303-1290
ISO/TS 10303-1033	ISO/TS 10303-1233	ISO/TS 10303-1292
ISO/TS 10303-1034	ISO/TS 10303-1240	ISO/TS 10303-1293
ISO/TS 10303-1036	ISO/TS 10303-1241	ISO/TS 10303-1294
ISO/TS 10303-1038	ISO/TS 10303-1242	ISO/TS 10303-1295
ISO/TS 10303-1040	ISO/TS 10303-1243	ISO/TS 10303-1296
ISO/TS 10303-1041	ISO/TS 10303-1244	ISO/TS 10303-1297
ISO/TS 10303-1042	ISO/TS 10303-1245	ISO/TS 10303-1298
ISO/TS 10303-1043	ISO/TS 10303-1246	ISO/TS 10303-1300
ISO/TS 10303-1044	ISO/TS 10303-1248	ISO/TS 10303-1301
ISO/TS 10303-1046	ISO/TS 10303-1249	ISO/TS 10303-1304
ISO/TS 10303-1047	ISO/TS 10303-1250	ISO/TS 10303-1306
ISO/TS 10303-1049	ISO/TS 10303-1251	ISO/TS 10303-1307
ISO/TS 10303-1054	ISO/TS 10303-1252	ISO/TS 10303-1340
ISO/TS 10303-1055	ISO/TS 10303-1253	ISO/TS 10303-1248
ISO/TS 10303-1056	ISO/TS 10303-1254	ISO/TS 10303-1357
ISO/TS 10303-1057	ISO/TS 10303-1255	ISO/TS 10303-1358
ISO/TS 10303-1058	ISO/TS 10303-1256	ISO/TS 10303-1364
ISO/TS 10303-1059	ISO/TS 10303-1257	ISO/TS 10303-1365
ISO/TS 10303-1060	ISO/TS 10303-1258	
ISO/TS 10303-1061	ISO/TS 10303-1259	
ISO/TS 10303-1062	ISO/TS 10303-1260	
ISO/TS 10303-1064	ISO/TS 10303-1261	
ISO/TS 10303-1065	ISO/TS 10303-1262	
ISO/TS 10303-1070	ISO/TS 10303-1263	
ISO/TS 10303-1105	ISO/TS 10303-1265	

## **2.6.18 AP240**

### **Numerical Control Process Plans for Machined Parts (ISO 10303-240:2005)**

(AP213 has been inactive since the 1996/1997 timeframe (after completing its DIS Ballot). It has become somewhat “out of date” as new related STEP Application Protocols have evolved. The scope given below represents the original AP213 Scope. During the First Quarter of 2002, AP213 will be reinitiated as a NWI as part of SCRA’s execution of the TACOM N-STEP Project. Proposed changes to the scope/requirements for the “new” AP240 are given at the end of this section. For more detail/discussion, see Documents 14, 15, and 16 in Appendix A.)

This part of ISO 10303 specifies information requirements for the exchange, archival and sharing of computer-interpretable numerical control (NC) process plan information and associated product definition data.



### 2.6.18.1.1 Scope

The following are **within** the scope of this part of ISO 10303:

- Information from the planning activity that is contained in the NC process plans for machined parts;
- Work instructions for the tasks required to manufacture a part, using numerical control, which include:
  - references to the resource required to perform the work;
  - the sequences of the work instructions;
  - relationships of the work to the part geometry;
  - references to standards and specifications declared in the process plan;
- information required to support NC programming of processes specified in the process plan (This includes product definition, administrative data, machine, tooling, and material requirements);
- Information required to support in-process inspection specified in the process plan (In-process inspection includes such tasks as using gage blocks or performing a probing operation to verify the dimensional constraints placed upon the part);
- shop floor information specified in the process plan (Shop floor information containing such items as part routing, machine setup, and part loading instructions).

### 2.6.18.1.2 Outside scope

The following are **outside** the scope of this part of ISO 10303:

- NC process information derived from, or required for, manufacturing preplanning activities (This includes information from activities such as factory capacity planning , scheduling, producibility analysis, and statistical process control);
- production control and scheduling analysis;
- production planning functions;
- actual execution of the process plan;
- continuous processes (Continuous process is the control of a process that requires feedback to determine new parameters such as those used in the manufacture of chemical and plating products);
- make or buy analysis activities;
- costing data;
- NC program, source programs, and specific machine tool controller codes;
- form features;
- drawing and production illustration contents;
- the process planning activity itself;
- inspection processes that require an inspection plan (Inspection processes refer to inspection that occurs outside the context of the NC machining process, such as removing the part and remounting it on a Coordinate Measuring Machine (CMM)).

### 2.6.18.2 Conformance Classes

AP240 has 6 Conformance Classes

The conformance classes are characterized as follows:

- cc 1: NC process plan information without shape;
- cc 2: cc 1 and shapes represented by non topological surface and wireframe models;

- cc 3: cc 1 and shapes represented by wireframe models with topology;
- cc 4: cc 1 and shapes represented by manifold surface models with topology;
- cc 5: cc 1 and shapes represented by faceted b-rep;
- cc 6: cc 1 and shapes represented by advanced b-rep.

cc 1 is a prerequisite for cc 2 through 6. If an implementation conforms to any of cc 2 through 6, then it shall also conform to cc 1.

## **2.7 SCOPES of AP's that are "Soon To Be" International Standards:**

### **2.7.1 AP219**

#### **Manage dimensional inspection of solid parts or assemblies (ISO/DIS 10303-219)**

This part of ISO 10303 specifies the use of the integrated resources necessary for the scope and information requirements for analyzing the data and reporting the results of dimensional inspections of solid parts or assemblies. Dimensional inspection can occur at any stage of the life cycle of a product where checking for conformance with a design specification is required.

NOTE The application activity model, in Annex F, provides a graphical representation of the processes and information flows which are the basis for the definition of the scope of this part of ISO 10303.

##### **2.7.1.1.1 Scope**

The following are within the scope of this part of ISO 10303:

- data for administering, planning;
- data for executing dimensional inspection;
- data for archiving the results of a dimensional inspection;
- interface for capturing technical data out of the upstream application protocols;
- machining feature classification structure;
- geometric and dimensional tolerances of the parts being manufactured;
- references to standards and specifications declared in the dimensional inspection.

##### **2.7.1.1.2 Outside scope**

The following are outside the scope of this part of ISO 10303:

- dimensional inspection of liquid surfaces,
- materials properties of parts,
- manufacturing activities;
- mathematical algorithms to perform the dimensional inspection analysis;
- developing or modifying manufacturing process information;
- generating geometry (creating the CAD model);
- generating tolerance requirements;
- inspection of material properties.

### 2.7.1.2 Conformance Classes

This part of ISO 10303 provides for only one option that may be supported by an implementation. This option shall all be supported by a single class of conformance which consist of all the units of functionality for this part of ISO 10303.

This conformance class is characterized as follows: dimensional inspection and shape represented by advanced b-rep.

### 2.7.2 AP221

#### Functional data and their schematic representation for process plants (ISO/CD 10303-221)

This part of ISO 10303 specifies the use of the integrated resources necessary for the scope and information requirements for functional data about a physical object within a process plant

#### 2.7.2.1.1 Scope

The following are within the scope of this part of ISO 10303:

- functional data about a physical object within a process plant;

Functional data consists of:

- the identification of a physical object;
- the decomposition of a physical object into sub-assemblies or sub-systems;
- connections between physical objects;
- the classifications of a physical object;
- the properties of a physical object.

A physical object within a process plant is one of the following:

- a system;
- an individual item of equipment;
- a component of a system or of an item of equipment;
- a batch of process or utility material; or
- a stream of process or utility material.

**EXAMPLE 1** Crude oil is a process material.

**EXAMPLE 2** Cooling water is a utility material.

A system within a process plant is one of the following:

- a system that handle process materials and utility materials;
- an auxiliary system for an equipment item;
- a process control and monitoring system;
- a safety, health and environmental control and monitoring system; or
- an electrical power generation, transmission and distribution systems with a process plant.

**EXAMPLE 3** A lubricating oil system is an auxiliary system for an equipment item.

**EXAMPLE 4** Equipment items and components within scope include:

- process equipment, such as vessels, columns, reactors, pumps, compressors, heat exchangers, boilers, furnaces, storage tanks, and their auxiliary systems;
- instrumentation items, such as control and safety/relief valves, gauges, and thermocouples;
- piping and pipe fittings;

- safety health and environmental system hardware, such as intrusion alarms, site access controls, weigh bridges, fire alarms, building automation systems, HVAC, smoke detectors, and sniffers.
- specification of an activity carried out by or on a system within a process plant;

The specification of an activity consists of:

- the identification an activity;
- the decomposition an activity into sub-activities;
- the connection between activities, where connection means that information or material flows from one activity to another;
- the classifications of an activity;
- the properties of an activity;
- the involvement of systems, equipment items and components, batches and streams of material, people, and organisations in an activity.

The activities within scope are:

- the transformation of a batch or stream of material;
- the transportation of a batch of material;
- the change of properties of a batch or stream of material;
- the change of properties, composition relationships, or connection relationships for a system or equipment item;
- the storage of a batch of material.

**EXAMPLE 5** A chemical reaction is a transformation.

**EXAMPLE 6** A flow through a pipe or wire, or via a conveyor belt, is a transportation.

**EXAMPLE 7** The heating of a fluid is a change of property.

**EXAMPLE 8** The holding of a batch of liquid in a tank is a storage activity.

- a schematic diagram, and the links between symbols on a schematic diagram and records of the physical objects or activities that that stand for;

The link between a symbol on a schematic and a physical object or activity makes the schematic 'intelligent'. An application can use this link to support access to data about the physical object or activity by clicking on the symbol.

The schematic diagrams within scope are:

- process flow diagram;
- piping and instrumentation diagram;
- logic diagram;
- instrument loop diagram.
- a representation of a reference data library of classes;

Classes represented by this part of ISO 10303 can specify the nature of the following:

- an individual physical object;
  - an individual activity;
  - an individual document, organisation or person;
  - a composition or connection relationship between physical objects or activities;
  - a property of a physical object or activity;
  - the involvement of a physical object, document, organisation or person in an activity.
  - a reference to a class within a reference data library;
- A reference can be made to a class within a reference data represented in any format, provided that the format gives each class within the library a unique identifier.

Formats that provide such identification include those defined by this part of ISO 10303, by ISO 15926-2, and by ISO 13584-42.

- a person and organisation and information about a person and organisation.

**EXAMPLE 9** Information about a person or organisation includes:

- identification;
- employment relationships;
- classification;
- the involvement of a person or organisation in an activity.

### 2.7.2.1.2 Outside scope

The following are outside the scope of this part of ISO 10303:

- conceptual process design, using process simulators;
- simulation or functional testing of systems;
- 3D shape representation of the plant items, and their spatial configuration in a 3D model;

This is in the scope of ISO 10303-227.

- detailed building automation installation information;

This is in the scope of ISO 10303-212 and ISO 10303-225.

- detailed physical design of process controls and monitoring systems and of electrotechnical systems;

This is in the scope of ISO 10303-212. However, the conceptual functional and physical design of process controls and monitoring systems and of electrotechnical systems is also in the scope of this part of ISO 10303.

- information about the plant infrastructure, where infrastructure includes items such as buildings, steel structures, concrete structures, roads, platforms, and ladders;
- management and cost information related to procurement and construction;
- measurements of actual stream properties such as flow rate, pressure, temperature, and composition, and measurements of actual equipment properties such as vibration levels;
- information related to plant operations and maintenance;
- content of a reference data library of classes.

Reference data library content relevant to process plants is within the scope of ISO 15926-4.

### 2.7.2.1.3 Modules

AP221, like AP203 2<sup>nd</sup> edition and AP239 contains several modules. To get a complete list of all the modules, review the modules listed in the table below.

**Table 10 — AP221 Modules**

<b>Application module</b>	<b>Application module</b>	<b>Application module</b>
ISO/TS 10303-421:2005	ISO/TS 10303-1213:2005	ISO/TS 10303-1203:2005
ISO/TS 10303-1151:2005	ISO/TS 10303-1151:2005	

### 2.7.2.2 Conformance Classes

This part of ISO 10303 provides for a number of options that may be supported by an implementation. These options have been grouped into the following conformance classes:

- CC1: functional\_data\_and\_their\_schematic\_representation\_for\_process\_plant\_cc1;

- CC2: functional\_data\_and\_their\_schematic\_representation\_for\_process\_plant\_cc2;
- CC3: reference\_data\_library\_and\_their\_schematic\_representation\_for\_process\_plant\_cc3.

Support for a particular conformance class requires support of all the options specified in that class.

Conformance to a particular class requires that all ARM elements defined as part of that class be supported. Table 1 defines the classes to which each ARM element belongs. Table 2 defines the classes to which each MIM element belongs.

**Conformance class for functional\_data\_and\_their\_schematic\_representation\_for\_process\_plant\_cc1 (CC1)**

The conformance class,

**functional\_data\_and\_their\_schematic\_representation\_for\_process\_plant\_cc1** has been declared against the module: Functional data and schematic representation (ISO 10303-421).

**NOTE** Conformance to **unctional\_data\_and\_their\_schematic\_representation\_for\_process\_plant\_cc1** requires that all ARM and MIM elements defined in the AP module (ISO 10303-421) be supported.

The scope of the **functional\_data\_and\_their\_schematic\_representation\_for\_process\_plant\_cc1** conformance class is:

- the classification, structure, properties and identification of products, activities, documents, organisations and people;

The structure of products includes both composition and connection relationships. A composition relationship can be either physical or functional. Similarly a functional relationship can be either physical or functional. Types or classes of relationship are defined in a Reference Data Library. The type of a relationship indicates whether it is functional or physical.

**EXAMPLE 1** 'Bolted connection' is a class of connection that is physical. The connection between pipe segment 'S12' and the inlet nozzle of vessel 'V4506' is a connection of this class.

**EXAMPLE 2** 'Signal connection' is a class of connection that is functional. The connection between instrument signal line 'i1' and the flow instrument '45-FT-501' is a connection of this class.

This capability is provided by the referenced Functional\_data application module.

- schematic diagrams that presents the classification, structure, properties and identification of products, activities, documents, organisations and people by the relative position of symbols; This capability is provided by the referenced Schematic\_and\_symbolization application module.
- associations between symbols on a schematic diagram and the things that the symbols represent.

This capability is provided by the referenced Schematic\_and\_symbolization application module. Application software can use the associations to make the schematic diagram 'intelligent'. This means that a user of the software can select a symbol on the diagram, and thereby obtain further information about the object that is represented.

**Conformance class for functional\_data\_and\_their\_schematic\_representation\_for\_process\_plant\_cc2 (CC2)**

The conformance class,

**functional\_data\_and\_their\_schematic\_representation\_for\_process\_plant\_cc2** has been declared against the module: Functional data (ISO 10303-1151).

The scope of the **functional\_data\_and\_their\_schematic\_representation\_for\_process\_plant\_cc2** conformance class is:

- individual product, library of classes of product, product structure and classification;  
This capability is provided by the referenced Product\_structure\_and\_classification application module.
- individual activity, library of classes of activity, activity structure and classification, involvement of a product, document, organization or person in an activity;  
This capability is provided by the referenced Activity\_structure\_and\_classification application module.
- properties of products and activities;  
This capability is provided by the referenced Property\_and\_property\_assignment application module.

### **Conformance class for reference\_data\_library\_and\_their\_schematic\_representation\_for\_process\_plant\_cc3 (CC3)**

The conformance class, **reference\_data\_library\_and\_their\_schematic\_representation\_for\_process\_plant\_cc3** has been declared against the module: Reference data library (ISO 10303-1213).

The scope of the **reference\_data\_library\_and\_their\_schematic\_representation\_for\_process\_plant\_cc3** conformance class is:

- a library of classes of product and their composition, connection, and containment relationships;  
This capability is provided by the reference

### **2.7.3 AP236**

#### **Furniture product data and project data (ISO/WD 10303-236)**

The model described by this AP concerns the relationship among the manufactures, suppliers and the end-user (retailers, major retailers and private customers) in the scope of the furniture industry. This AP refers to product definition (furniture) and interior design projects (decorating projects) in order to allow the exchange of Product Libraries (catalogues and decorating projects) and Orders, including graphic information.

### **2.7.4 AP238**

#### **Application interpreted model for computerized numerical controllers (STEP-NC) (ISO/PWI 10303-238)**

This part of ISO 10303 specifies the use of the integrated resources necessary for the scope and information requirements for manufacturing using numerical controlled machining and associated processes, including the scope and information requirements defined by the ISO 14649 data model for computerized numerical controllers.

**NOTE 1** The application activity model in annex F provides a graphical representation of the processes and information flows that are the basis for the definition of the scope of this part of ISO 10303.

### 2.7.4.1 Scope

The following are within the scope of this part of ISO 10303:

- mechanical parts for manufacturing;
- manufacturing process descriptions, including manufacturing operations, sequences of operations, and associated information as defined in ISO 14649;
- the AS-IS and TO-BE shapes of a mechanical part;
- manufacturing features of a part;
- manufacturing tolerance requirements of a part;
- tool requirements for machining operations;
- tool paths for machining operations;
- manufacture of mechanical products using manufacturing processes defined in ISO 14649;
- manufacturing product discipline view.

### 2.7.4.2 Outside scope

The following are outside the scope of this part of ISO 10303:

- composite material parts;
- description of manufacturing activities not related to automatic execution by a computerized numerical controller;  
**NOTE 2** This includes activities such as factory capacity planning and scheduling.
- a catalog of machines available on a factory floor;
- a catalog of tools available in a machine tool magazine;
- design features of a part;
- manufacturing preplanning activities;
- product discipline views other than manufacturing.

### 2.7.4.3 Conformance Classes

This part of ISO 10303 provides for a number of options that may be supported by an implementation. These options have been grouped into the following conformance classes:

- CNC-independent tool paths (CC1);
- Intelligent setup (CC2);
- Conditional programming (CC3);
- Generative programming (CC4).

These conformance classes are defined so that each class includes all the options specified by the preceding class. Support for a particular conformance class requires support of all the options specified in that class.

**EXAMPLE** CC2 contains everything in CC1, plus additional options. CC3 contains everything in CC2, plus additional options. CC4 contains everything in CC3, plus all remaining options.

Conformance to a particular class requires that all AIM elements defined as part of that class be supported.

#### **Conformance Class for CNC-independent tool paths (CC1)**

This conformance class supports the description of machining programs containing a single sequence of operations, each of which is described using the machine-independent path of the tool center point, using



a simplified set of curves types, as well as tool requirements, management information about the program, and all technology-specific process parameters.

This conformance class includes all application objects from the management, measure, operation, project, workpiece, process data for milling, cutting tools for milling, process data for turning, and cutting tools for turning UoFs.

**NOTE** - Since this conformance class requires a toolpath for every operation, any specified strategy is simply for additional information. In the absence of any other useful information, it is recommended that the machining operation be specified as a Freeform\_operation with no associated strategies.

This conformance class includes the following application objects and their supertypes from the executable UoF:

- Machining\_tool and the supporting objects Cutting\_tool, Cutting\_component, Cutting\_edge\_technological\_data, and Tool\_body;
- Machining\_workingstep;
- NC\_function, the subtypes Display\_message, NC\_legacy\_function, Optional\_stop, Program\_stop, Set\_mark, Wait\_for\_mark, and the supporting object Channel;
- Rapid\_movement and the subtype Return\_home;
- Setup and the supporting objects Workpiece\_setup and Setup\_instruction;
- Workplan.

This conformance class includes the following application objects and their supertypes from the toolpath UoF:

- Cutter\_location\_trajectory;
- Feedstop;
- Toolpath\_speed.

In addition, the following apply to use of the application objects in this conformance class:

- the its\_toolpath shall be specified for each Operation object;
- the its\_feature need not be specified for a particular Machining\_workingstep object;
- the final\_features shall not be specified for any Machining\_workingstep object;
- the dataset shall contain exactly one Workplan object;
- the basiccurve, its\_toolaxis, and surface\_normal for each Cutter\_location\_trajectory object shall be described using only polylines, composite or trimmed curves based upon lines or conics;
- no geometric shape information shall be specified for Machining\_workingstep its\_effect, Manufacturing\_
- feature explicit\_representation, Workpiece its\_geometry or its\_bounding\_geometry,
- Workpiece\_setup its\_restricted\_area, or Workplan its\_effect.

## **Conformance Class for intelligent setup (CC2)**

This conformance class extends the previous conformance class to support the description of machining programs with the full range of toolpath specifications as well as full shape information for the workpiece, rawpiece and restricted areas on the setup.

This conformance class includes everything specified by CC1, plus all remaining application objects from the toolpath UoF and the Parallel application object from the executable UOF.

In addition, the following apply to use of the application objects in this conformance class:

- the dataset may contain multiple, nested Workplan objects;

- the basiccurve, its\_toolaxis, and surface\_normal for each Cutter\_location\_trajectory object may be described by any bounded\_curve type;
- geometric shape information may be specified for Machining\_workingstep its\_effect, Workpiece its\_geometry or its\_bounding\_geometry, Workpiece\_setup its\_restricted\_area, or Workplan its\_effect.

### **Conformance Class for conditional programming (CC3)**

This conformance class extends the previous conformance class to support the description of machining programs using the full range of executable constructs and manufacturing process features defined by implicit parameters.

This conformance class includes everything specified by CC2, plus all application objects from the manufacturing feature and manufacturing feature for turning UOFs and all remaining application objects from the executable UoF.

In addition, the following apply to use of the application objects in this conformance class:

- the its\_toolpath need not be specified for a particular Operation object;
- the its\_feature shall be specified for all Machining\_workingstep objects.

### **Conformance Class for generative programming (CC4)**

This conformance class extends the previous conformance class to support the description of geometric dimension and tolerance information sufficient to compute optimal speeds and feeds, manufacturing features appearing on the final product shape, and features with linkage to explicit geometry.

This conformance class includes everything specified by CC3, plus all application objects from the geometric dimensioning and tolerancing UOF and all remaining application objects from other UoFs.

In addition, the following apply to use of the application objects in this conformance class:

- the final\_features may be specified for any Machining\_workingstep object;
- the explicit\_representation may be specified for any Manufacturing\_feature object.

## **2.8 SCOPES of AP's that are "In Process"**

### **2.8.1 AP223**

#### **Exchange of design and manufacturing product information for cast parts (ISO/PWI 10303-223)**

This part of ISO 10303 specifies the use of the integrated resources necessary for the scope and information requirements for exchange, archiving and sharing of design and manufacturing product information for cast parts.

NOTE 1 The application activity model, in Annex F, provides a graphical representation of the processes and information flows which are the basis for the definition of the scope of this part of ISO 10303.

### 2.8.1.1 Scope

The following are within the scope of this part of ISO 10303:

- the manufacturing of a cast part made by sand, die, and investment casting processes;
- parts that are to be manufactured by casting processes;
- design data for cast parts, including geometry, materials, tolerances, required physical and mechanical properties, required tests;
- casting features for defining shapes necessary for casting processes;  
**NOTE 2** The casting feature set is defined in this part of ISO 10303.
- manufacturing features for defining shapes necessary for machining processes;
- manufacturing features for defining shapes necessary for casting process;
- explicit representation of the 3D shape of casting features through bounded geometry representations;
- geometric and dimensional tolerances of the parts being manufactured;
- materials, and properties of the parts being manufactured.
- characterization of products used to make cast parts, including molds, dies, equipment, materials, and consumable items;
- customer order administrative data to track receipt of an order for a cast part to the shop floor, but not including tracking of the order on the shop floor;
- approval data to authorize the manufacture of a cast part;
- requisition administrative data to identify requirements and track the status of materials and equipment needed to manufacture a cast part;
- work order data to track and identify the status of a cast part;
- tracking the state of raw stock for documenting the manufacturing history of a cast part;
- tracking a design exception notice of a cast part.  
**NOTE 3** The design exception notice relates to discrepancies in the features used to describe a cast part's shape.
- process plans for parts that are made by sand, die, and investment casting processes;
- process data for part routing which includes manufacturing process and setup sequencing;
- process data for operation.
- work instructions for the tasks required to manufacture a cast part, using which include:
  - references to the resources required to perform the work;
  - the sequences of the work instructions;
  - relationships of the work to the part geometry.
- specifications for patterns and die assemblies;
- input to and output from casting process simulation software;
- data exchange between customer and foundry, within the foundry, and between foundry and supplier;
- use of data for foundry automation and shop floor control;
- use of data for archiving of design and manufacturing data for cast parts.  
**NOTE 4** Data supported by this AP may need to be archived to meet legal and regulatory requirements, and to meet quality objectives.

### 2.8.1.2 Outside scope

The following are outside the scope of this part of ISO 10303:

- centrifugal cast parts;
- data describing rules, guidelines and expert knowledge used to design and manufacture cast parts;

- data describing why a particular design or manufacturing decision was made;
- forging data;
- pit molding;
- shop floor scheduling data;
- process plans for making patterns, dies, and other tooling;
- algorithms used to obtain simulation results.

### 2.8.1.3 Conformance Classes

The conformance classes are specified using combinations of UoFs as given in table 1. Conformance class 1 is required as a minimum conformance, classes 2 thru 8 conform to class 1 as well as their own conformance. This part of ISO 10303 uses three AICs. These AIC define boundary representation geometry, machining features, and geometric tolerances which are used by all conformance classes.

Conformance to a particular class requires that all AIM elements defined as part of that class be supported. Table 2 defines the classes to which each AIM element belongs.

The conformance classes are characterized as follows:

- Class 1: Minimum for all conformance classes;
- Class 2: Customer to metal caster;
- Class 3: Metal caster to inspection;
- Class 4: Metal caster to simulation;
- Class 5: Metal caster to tooling shop;
- Class 6: Metal caster to other operations;
- Class 7: Customer to simulation;
- lass 8: Casting process planning.

## 2.8.2 AP229

### Design and manufacturing product information for forged parts (ISO/NWI 10303-229)

This AP will address the exchange, archival storage and sharing of design and manufacturing product information for forged parts. The forging process involves transforming the primary stock into a finished part with possibly a number of intermediate stages. Distinct products which make up stages in this sequence, and which are defined in this AP, include: primary stock, preform, near-net shape part after forging and net shape or finished part after finishing operation. Included are the characteristics of any of the above listed parts such as geometry, tolerances, surface finish, functional requirements, e.g., maximum design stress, material, and inspection and testing results. The characteristics of the forging process are also included, such as forging method, forging steps and lubrication. Also included within the scope of this AP is the tooling and equipment specification.

The following are **outside** the scope of this AP:

- process selection for near net shape manufacturing,
- product design modification for forging,
- management decisions used to forge a part,
- processing of the primary stock,
- forging die making,
- process control method,

- forging process simulation methods,
- finishing techniques and equipment,
- inspection techniques and equipment.

### 2.8.3 AP233

#### Systems engineering data representation (ISO/WD 10303-233)

STEP AP233 (Systems engineering data representation) describes the key systems engineering product data information that must be exchanged between dissimilar requirements tools and product model definition systems. Industries that can benefit from using AP233 are Automotive, Aerospace, Shipbuilding, Process Planning (e.g., Petroleum), Electronics, and others with complex products and processes.

#### 2.8.3.1 Scope

The following are within the scope of this part of ISO 10303:

- project management (management resources, organization structure, project breakdown, schedule, work structure)
- system requirements (text and function based requirements)
- system behavior (function based behavior with place holder for state based behavior)
- system structure (breakdown, interface, analytical mode, rules, model parameter)
- system risk

#### 2.8.3.2 Outside scope

AP233 is still under construction and the out of scope statement has not yet been developed.

#### 2.8.3.3 Modules

The System Engineering Project is following a modularized approach to develop standardized data models for systems engineering information. By breaking down systems engineering into well-defined sub-domains that map to existing commercial software tools and products, the project plans to package its accomplishments as a series of phased deliveries through 2007.

The following modular capabilities are planned and under development in the project:

- **Text-based Requirements [TBR ]** - a data model that describes requirements as text strings with traceability, allocation, weighting, and risk identified with each requirement
- **Property-based Requirements [PBR]** - a data model that describes requirements as structured and quantified formalisms (including tables, spreadsheets, graphs, charts, pictures and equations) that may be derived from text-based requirements

- **Structural Models** - a data model that:
  - Describes how a system is built
  - Defines the static relationships among the subsystems, components, or parts that actually constitute the system
  - Describes what is designed, built and maintained
  - Contains specifications for design, manufacture, and maintenance, and information about actual manufactured parts and their verification and maintenance
- **Behavioral Models** - a data model that describes how a system performs; includes functions, inputs, outputs and control operators which define the ordering of functions; the model describes Functional Flow Block Diagrams, Finite State Machines, Causal Chain, Data Flow Diagrams, and Sequence Diagrams
- **Data Presentation** - a consistent set of presentation mechanisms and advanced schematics product model definition designed to present the computer sensible model data (defined in representation model space) onto a human understandable schematic diagram (presentation space), conforming to conventional and/or future draughting standards
- **Risk Analysis** - a data model that identifies risk(s), describes their status, specifies relationships, likelihood, consequence, impact approach strategy, and contingencies
- **Cost Models** - a data model that describes direct, indirect, fixed, variable, material, administrative, finance, and contingency costs, and provides linkage to system product structure(s)
- **Scheduling** - a data model that identifies activities, dependencies, durations, and milestones associated with products described in the WBS, and includes Workflow Diagrams, Network Schedules, Gantt Charts, and Resource Leveling

#### 2.8.3.4 Conformance Classes

This part of ISO 10303 provides for only one option that may be supported by an implementation:

- CC1: System engineering and design.

This option shall be supported by a single class of conformance that consists of all the ARM elements defined in the AP module (ISO 10303-433).

Conformance to a particular class requires that all ARM elements defined as part of that class be supported. Table [1](#) defines the classes to which each ARM element belongs. Table [2](#) defines the classes to which each MIM element belongs.

#### **Conformance class for System engineering and design (CC1)**

The conformance class, **System engineering and design** has been declared against the module: AP233 system engineering and design (ISO 10303-433).

NOTE - Conformance to **System engineering and design** requires that all ARM and MIM elements defined in the AP module (ISO 10303-433) be supported.

The scope of the **System engineering and design** conformance class is:

- project management (management resources, organization structure, project breakdown, schedule, work structure)
- system requirements (text and function based requirements)
- system behavior (function based behavior with place holder for state based behavior)
- system structure (breakdown, interface, analytical mode, rules, model parameter)
- system risk

## 2.8.4 AP235

Engineering properties for product design and validation (ISO/WD 10303-235)

### **Abstract**

This Part of ISO 10303 specifies the information objects and information structure to represent data for engineering properties of products. The nature of engineering properties depends on the methods of measurement and the magnitude of the value obtained depends on the conditions used during the measurement. This application protocol provide the means to describe the processes and the conditions involved in deriving engineering properties used for design, together with the administrative and supporting information that ensures that those processes were valid. The specification can be used for any engineering property measured by any method and is not limited to so-called material properties. The names and details of such methods and their properties are not included in this standard but are assumed to be defined in a computer-processable dictionary to which this standard can make reference.

### **Scope**

The following are within the scope of this part of ISO 10303:

- descriptions and definitions of the manufactured product, the sample of the product and the testable version of the sample;
- description of the composition and substance of the product;
- description of the processes used in the measurement;
- descriptions of the data values produced by the measurement, with the specification of the conditions in which the data is valid;
- references to standards and other documents wherein sampling, measurement and other details of testing and measurement processes may be specified or described;
- descriptions and qualifications of the personnel and or organisations responsible for the measurement;
- specification of the requirements, conditions and tolerances to be satisfied in the measurement and a description of the outcome;
- descriptions of the locations of the measurement process and the effectivity of the results.
- descriptions of the approval that establishes the validity of the measurements and the use of the properties for product design and design validation.

The following are outside the scope of this part of ISO 10303:

- data describing rules, guidelines and expert knowledge in the testing of products;
- names of properties and test methods;

- data describing why a decision was made to use a particular process;
- scheduling data for measurement processes;
- algorithms used for data evaluation and data processing.

NOTE The names and definitions of properties and test methods are assumed to be provided in computer processable dictionaries, conforming to ISO 13584 Parts Libraries, or reference data libraries conforming to ISO 15926.

### Conformance classes

Not determined yet. Will be specified in the DIS.

### Modules used

The AP does not use modules.

### UoFs

The UoFs and some indication of their contents are shown in the table below.

<b>activity</b> – activities planned and realised, activity relationships, resources	<b>administration</b> – date, time, event, event relationship, contract, project, specification
<b>approval</b> - approval, certificate, security classification	<b>condition</b> – condition, condition assignment, condition relationship
<b>document management</b> - document, document relationship, digital record, file, file location, hardcopy	<b>effectivity</b> – effectivity, effectivity relationship, dated, lot, serial, time-interval effectivity
<b>engineering property</b> – engineering property, property representation, property value, property environment	<b>geometry</b> – axis placement, cartesian point, curve, Cartesian transformation, shape, shape dimension, shape element
<b>geometric tolerance</b> – angularity, coaxiality, concentricity, flatness parallelism, straightness, symmetry	<b>location</b> – address, global location, organization location product location
<b>measure</b> – numerical measure, unit, unit conversion, maths value, maths function, qualifiers, uncertainties	<b>person organization</b> – person, organisation, qualification, address
<b>product</b> – product type and individual, planned and realised, product relationship	<b>quality assurance</b> – class defined by evaluated condition, class defined by requirement
<b>requirement</b> – required resource, resource assignment, resource relationship, requirement source	<b>state</b> – derived state, process state, property state, state type, state type relationship
<b>substance</b> – chemical element, element amount, composition, structure, structure element, structure element relationship	<b>tolerance datum</b> – target area, circle, point, rectangle, straight line

## 2.9 STEP Application Suites

This section provides some descriptions of "suites" of STEP Application Protocols as they apply to general application domains. In contrast to the way in which AP214 (ISO 10303-214:2001) - "Core Data for Automotive Mechanical Design Processes" addresses the Automotive domain in a single Application Protocol, the following "suites" use a series of Application Protocols, Integrated Resources, and Application Integrated Resources to address the application domain. Here, we briefly identify the



Manufacturing Suite, the Shipbuilding Suite, the Electromechanical Suite, the Process Plant Suite, the System Engineering Suite, the Engineering Analysis Core Model, Product Life Cycle Support, and funSTEP and indicate some of the pilot/prototype/prove-out activities in these application domains. Some additional references are cited for further information.

## 2.9.1 Manufacturing Suite

### STEP in, STEP out, STEP throughout With Machining features

#### AP harmonization

An integral part of the development of APs for manufacturing is to harmonize elements of requirements that are common across these different manufacturing domains. AP219, AP223, AP224, AP238, and AP240 define different data representations for the different manufacturing life cycles of data. However these APs all have data within their scope and context that is common with the other APs, for example: dimensional and geometric tolerances, boundary representation geometry, properties, raw material data, and machining features. The intention of the standards organization is that vendors will supply software products which will exchange and interpret product data according to the specification prescribed in an application protocol. A primary criterion will be a product's adherence to one or more STEP APs. Therefore harmonization of "like" concepts such as machining features is extremely important and will more completely ensure data integrity of the product data of the design throughout the manufacturing domains. Figure 3 and Figure 7 reflect the need for design to manufacturing domain interaction and correspondence.

(Note: AP229, Design and manufacturing product information for forged parts, is currently a STEP New Work Item in the early stages of development and will be added to the STEP Manufacturing Suite (SMS) in the near future.)

#### Features as key elements

Manufacturing processes are placing new demands for more intelligent product data. Applications are now capable of handling a more semantically rich data set for the product data and require more than just geometric definitions. To meet these requirements features are being used to define more semantically endowed information about the part product information. To understand the use of features for manufacturing a few terms are defined:

**Features:** The geometric elements and orientation that define surface information and volumes without any semantics.

**Semantics:** the meaning or implication associated with the manufacturing process for the removal of a volume of material.

**Machining feature:** is the combination of a feature and semantics. Therefore it is the geometric information about a well defined shape, and the manufacturing semantics that aid in associating manufacturing volume removal process.

**Manufacturing feature:** is the combination of a feature and the implication that material volume has been removed creating a feature. This is the case for the "casting feature".

## Integrated Manufacturing Architecture using Machining features

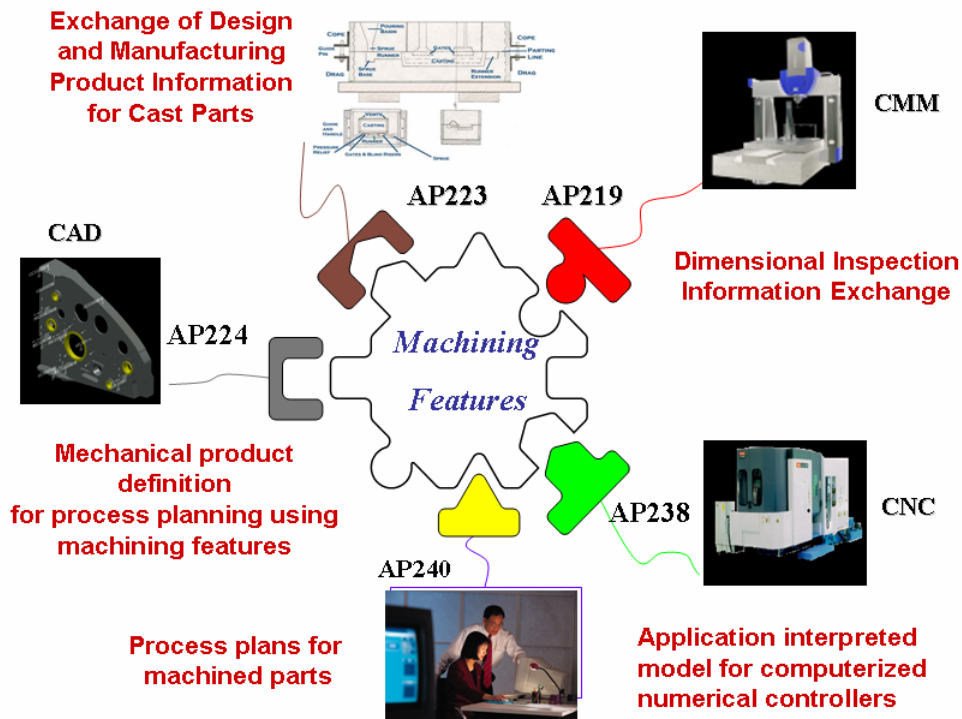

Figure 3 — APs using Machining features

### Feature design structure

A consistent approach was used to develop the structure of a feature. Features are primarily defined as the combination of a profile shape and a path shape.

### Feature profile shapes

Feature profile shapes are two dimensional implicit or explicit shape definitions with attributes such as length, width, height, corner radius, radius, and diameter are combined to define a two dimensional shape. For example a V profile is defined implicitly as the length of two lines, an angle between the lines, and a corner radius as depicted in Figure 4.

In order to create a wide range of features, several profiles have been defined in two different categories, open profiles are those that have an open end, and closed profiles are those that are defined as an enclosed area.

In cases where features are created and the shape profile can not be defined in clear-cut distinct shapes, general shape profiles are explicitly defined with two-dimensional geometry, such as curves or splines.

## Feature path shapes

Feature paths are similar to profiles; they are implicit shape definitions or three dimensional explicit shape definitions that define a path in which the entire feature profile is defined. For example an outer diameter to shoulder feature is defined as a V profile defined along a complete circular path, see Figure 4.

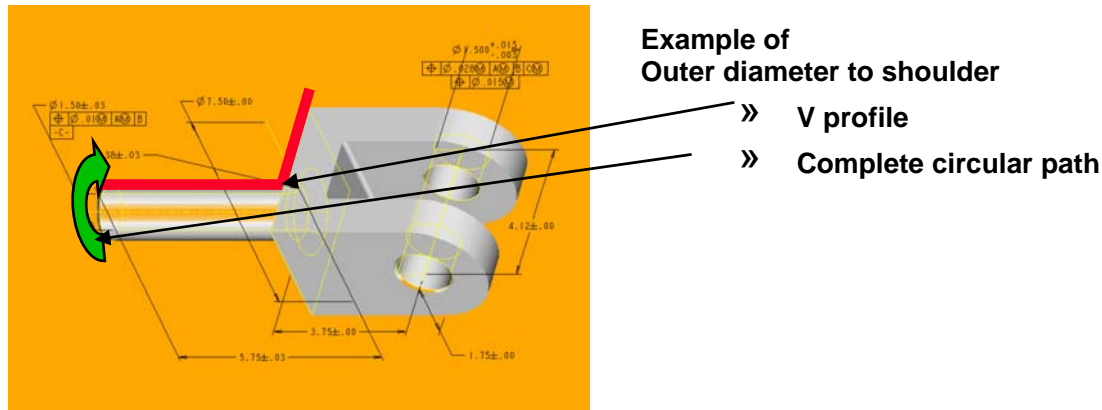
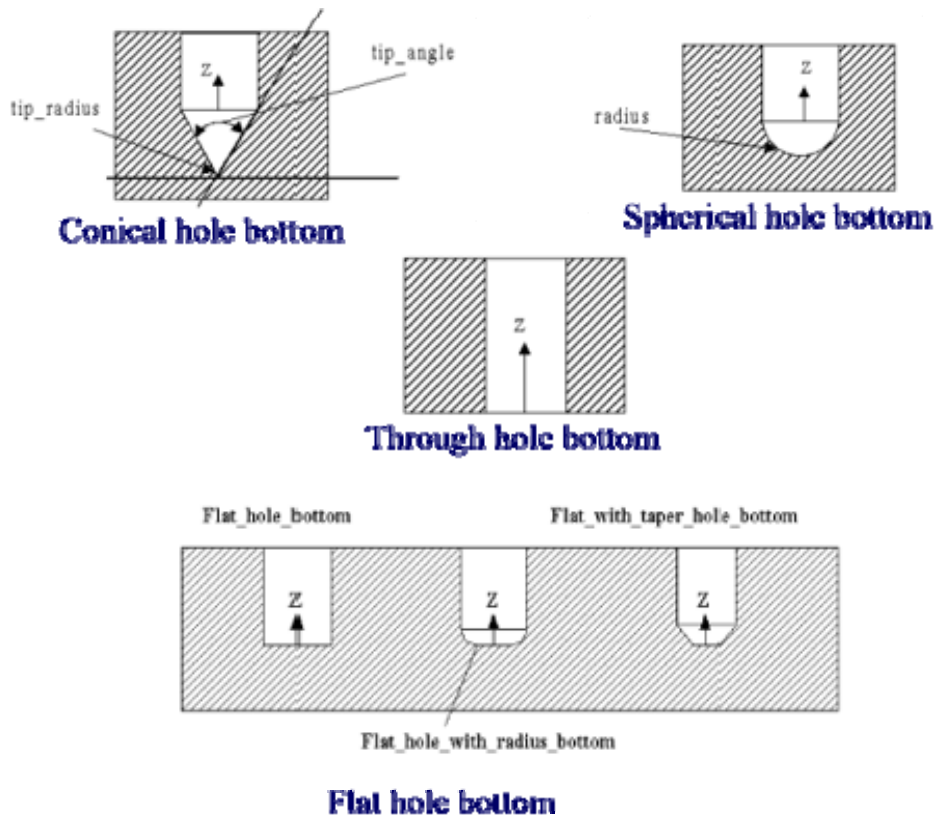

**Figure 4 — Example of complete circular path with V profile**

In cases where features are created and the shape path can not be defined in clear-cut distinct shapes, general shape paths are explicitly defined with three-dimensional geometry, such as curves or splines.

## Feature specific definition elements

Besides path and profiles, features contain additional structural elements to further define their semantics. Each feature has an orientation attribute to define location and direction for placement of the feature on the part. Features may also have a taper element to define a tapered feature such as a tapered hole, draft, pocket, or boss. In addition, certain features have implicit or explicit shape definitions to define feature end conditions. Slot feature has slot end type definitions, pocket features have bottom type definitions, the boss feature has a top definition, and a hole has a bottom definition. Figure 5 shows examples for the bottom of a hole feature, the shape is either flat, spherical, conical, or there is no hole bottom; thus the hole goes all the way through the part.



**Figure 5 — Hole bottom types**

## Machining features

The machining feature design structure is used to create a suite of features that can be machined by machine operations. By combining paths, profiles, tapers, and end conditions a large variety of machining features is defined. A *'step feature'* is created by combining a linear path, and a linear profile, a *'slot feature'* can be created by using any type of path element, any type of open profile definition, and two slot end shape definitions. A *'hole feature'* can be created by a linear path element, complete circular profile element, a hole bottom definition, and optionally a taper definition. A *'counterbore hole'* is the combination of two holes, one larger than the other. For cases where shapes can not be well defined with implicit feature definitions protrusion and general geometric shape entity have been created. These features are defined by any irregular shape definition.

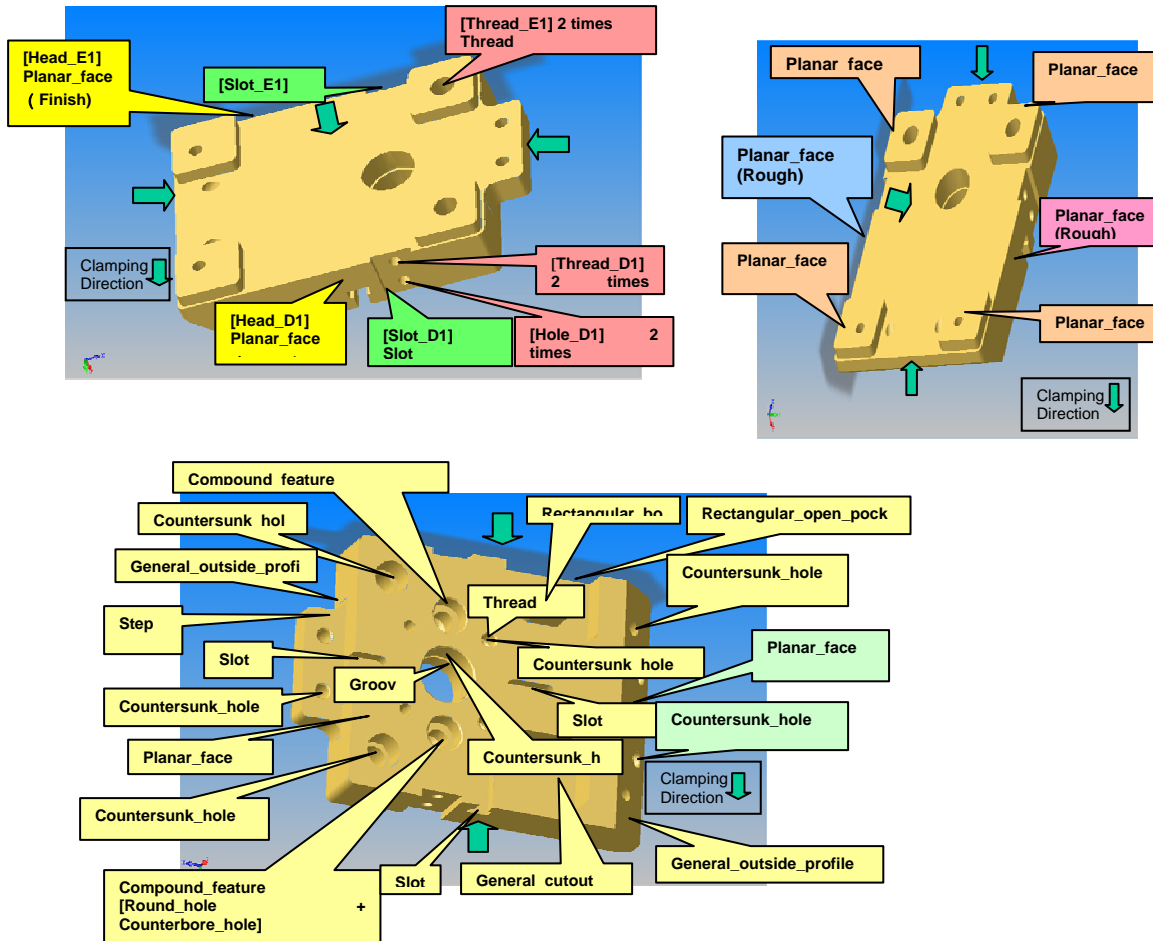

**Figure 6 — Machining feature example**

There are some features that are not defined geometrically but need to be defined as machining features; these are features like Thread, Marking, Knurl, and Gear. A design engineer will typically define where on the part these features occur, and constructs a note to indicate where to find the specifications to make any one of these four features, such as an ISO or ANSI specification. These four machining features are defined in the same manor, i.e., the location on the part and an identifiable shape are defined for the feature along with an attribute to reference an external document that specifies the specific attributes for creating one of these four machining features.

### **Additional feature characteristics**

The requirements for machining features also include the capability to define feature combinations. This is achieved through the compound feature and replicate feature. The compound feature enables the creation of a feature that is a combination of features. For example, a compound feature could be a hole feature inside another hole feature as shown in Figure 6. Or another possibility of a compound feature is a recess feature in the bottom of a pocket feature. The replicate feature allows for replication of any feature in a circular pattern, rectangular pattern, or a general pattern. With the replicate feature only one base feature needs to be defined along with the number of replications of the base feature. This is convenient, for example, when replicating a pattern of holes on a part.

## **Relating critical data to machining features**

Besides representing the semantics of shape, machining features are extremely useful in relating manufacturing information to the semantic shape. When a part is designed, there is valuable design information that is directly related to the specific features on the part. Much of this design information is provided to control the form, fit and function of the part during the manufacturing process. Geometric dimensioning and tolerancing is the means used by this suite of APs to relate the information about the precision of the manufactured part. In addition, certain property specifications and conditions may be a part of the design information supplied to the manufacturing domain. Examples are a cylindricity tolerance applied to a hole feature, or a hardness property applied to a planar face feature. Exchanging this information to manufacturing processes gives a more complete and precise definition of the feature with its associated tolerances and properties.

## **Dimensional tolerances**

When the designer defines a feature on a part, tolerance information is added to indicate the required precision to manufacture the part. This precision is established by defining size and location dimensional tolerances. For example a 2" diameter hole may have a diameter dimensional tolerance of a plus or minus tolerance of .005". This type of tolerance can be applied to the implicit parameters of a hole feature. One of the attributes of the hole feature is diameter, the size tolerance can be applied directly to that attribute. Or the diameter dimensional tolerance could be applied to the geometric shape that defines the hole, or the tolerance could be applied to both. Likewise a location tolerance may be used to locate the hole feature with respect to another hole feature on the part. This tolerance could be related to the two hole features, or to the explicit geometry of the hole features.

## **Geometric tolerances**

AP224 was the first ISO 10303 AP to define exchange data to support the ISO 1101 and ANSI Y14.5M geometric tolerances which includes: Angularity tolerance, Circular\_runout\_tolerance, Circularity tolerance, Concentricity tolerance, Cylindricity tolerance, Flatness tolerance, Linear profile tolerance, Parallelism tolerance, Perpendicularity tolerance, Position tolerance, Straightness tolerance, Surface - profile tolerance, Symmetry tolerance, and Total runout tolerance.

Like dimensional tolerances, geometric tolerances may be used with respect to the features on the part, or the geometric shapes that define the features. For example a hole feature may have a dimensional tolerance defining the diameter and depth of the hole, and may also have a concentricity tolerance with respect to some datum defining the geometric tolerance.

## **Properties**

Properties may be something that is defined for use on the entire part, or they may only apply to a portion of the part. Besides tolerances there may also be a useful advantage to associate properties to a feature during manufacturing. A part may have several types of properties; some of which may include material, process, or surface properties. For example, a planar face feature may need to have a heat treat process applied to it, or a pocket feature may require a protective finish treatment. By attaching these properties directly to the feature, we can use the semantics of the feature to precisely define where these properties are applied.

In summary, the feature semantics not only give us a more robust user understandable definition for shape on a part, but it also allows for relating the feature definition to critical data such as tolerances and

properties. This gives the design domain the capability of exchanging a nearly complete packet of digital information about the part to the manufacturing domain. The old cliché of – “engineering throwing the design over the wall to manufacturing” is basically gone. All domains are now using the same digital information for the part.

## Manufacturing applications using machining features

To this point this section of the document has explained manufacturing features, their semantics, definition elements, and relating critical data. However there are several APs using manufacturing features to support product data for different life cycle information pertaining to part manufacturing. Now the usage of machining features in ISO 10303 standards for manufacturing will be discussed.

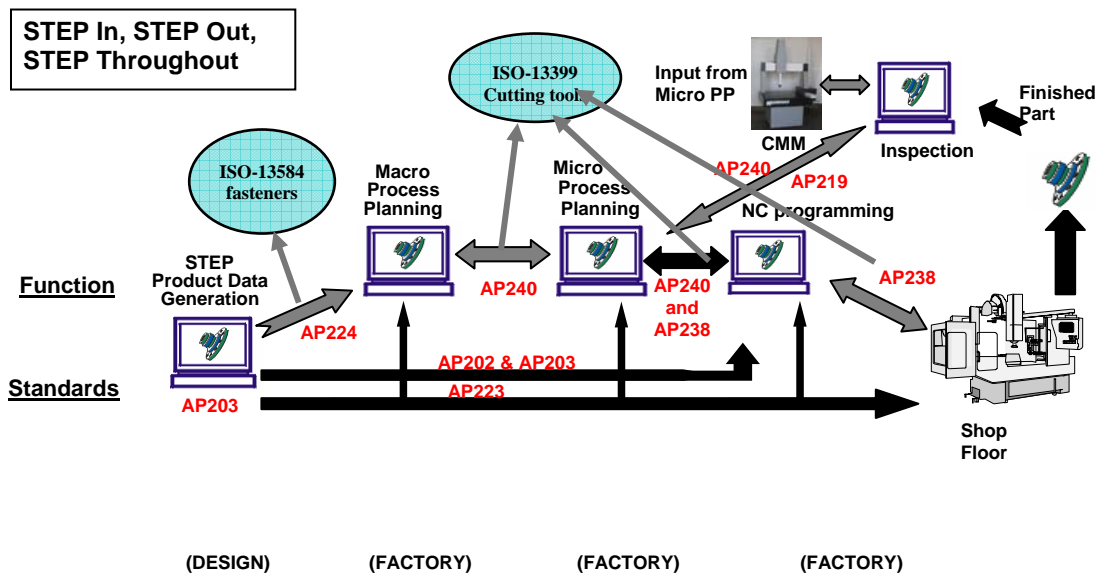
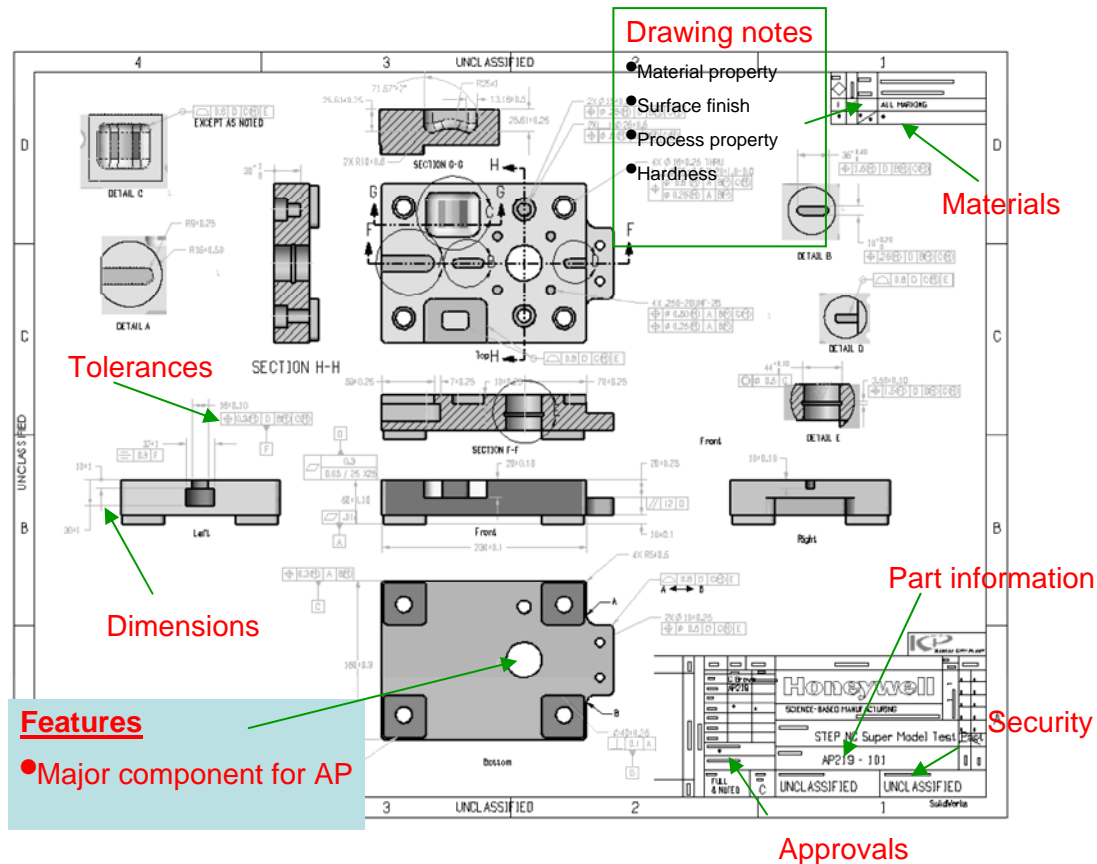

Figure 7 — A STEP Manufacturing Suite

## Design to Process Planning

As previously mentioned AP224 was the first AP to define and use machining features within ISO 10303 to be published as an ISO Standard. The purpose of AP224 is to bridge the gap between design and manufacturing by providing machine part information that ensures the design information is 100-percent complete, accurate, computer-interpretable and reusable. Many computer-aided process planning (CAPP) systems on the market enable automated process planning from product data in a digital format. The AP224 standard provides the mechanism to define the digital data that contains the information necessary to manufacture a required part.



**Figure 8 — AP224**

AP224 defines the exchange of information from design to manufacturing; an example of a typical AP224 exchange is shown graphically in Figure 8 – AP224, using a typical part drawing as a reference. The AP defines the explicit feature with geometry using boundary representation (B-rep), and implicit feature with the machining feature definitions. AP224 defines the dimensional and geometric tolerances that can reference either the B-rep geometry, or the implicit feature definition. AP224 also defines part, process, material, and surface properties that can reference B-rep geometry or the implicit feature definition. Also defined in this AP is the implicit or explicit base shape of the part, in other words, the starting raw stock definition from which to manufacture the part. The explicit shape may be considered as a cast or forged shape, the implicit shape is defined as a piece of bar stock. The raw stock definitions also reference the machining features, that define the material removal.

A manufactured assembly was added in the second edition of this AP, and machining features play an important role as several parts in the assembly have features in common. For example there may be two parts that require several holes to be machined through both parts. Therefore these hole features and associated data such as tolerances and properties can be defined across both parts. A process plan would contain product data for both parts to be placed together on a machine, so the hole could be machined through both parts at the same time. Creating a hole feature that has a relationship with both parts will aid process planning and reduce process time.



## **Process plans for machined parts**

AP240 defines the macro, high level, process plans for machining parts. AP240 uses machining features, dimensional tolerances, geometric tolerances, properties, shape geometry, and part definition in precisely the same way they are used in AP224 and have been harmonized with other APs for manufacturing as previously mentioned. This AP then utilizes machining features in many ways for the product definition in the process plan.

## **Features assigned to process**

A part may have many features on several sides of the part. In order to machine the part it may require several setups on one or more machines, and each setup may have several machining operations to remove material from the part. The AP240 process plan defines the sequence of machine processes. Each machining process identifies the machine tool, the machine setup, clamping positions, a list of machine operations, and a list of machining features that are eligible to be machined per process. This list of machining features is not the list of all features on the part, but a subset of the part features that are eligible to be machined for a particular machine setup and machining process on a specified machine.

## **Features assigned to operations**

Each machining setup identifies one or more machining operations. A machine operation may be rough mill, finish mill, drill, tap or countersink. A list of machining features is specified for each operation. For example, a countersink operation would identify a countersunk hole, or a rough mill operation would identify a pocket.

## **Clamping position**

The part is secured to the machine before a machining operation. AP240 defines the type of clamp to use, location on either the machine tool or fixture, and what portion of the part shape is being affected by the clamp position. If there are no machining features at this clamping location, the geometric shape is identified and machining continues; however, the machining feature is specified if the clamp location is positioned on top of the feature and the feature may not be machined during that setup.

## **Feature dependency tree**

When machining a part certain features require machining prior to the machining of additional features. For example if there is a counterbore hole feature in the bottom of a pocket feature, the pocket would need to be machined first, and the counterbore hole afterwards. The process plan information includes a feature dependency tree. This tree is an ordered list of machining features indicating a sequential order for processing features. An example of a sequential list of operations is shown in Figure 9 – AP240.

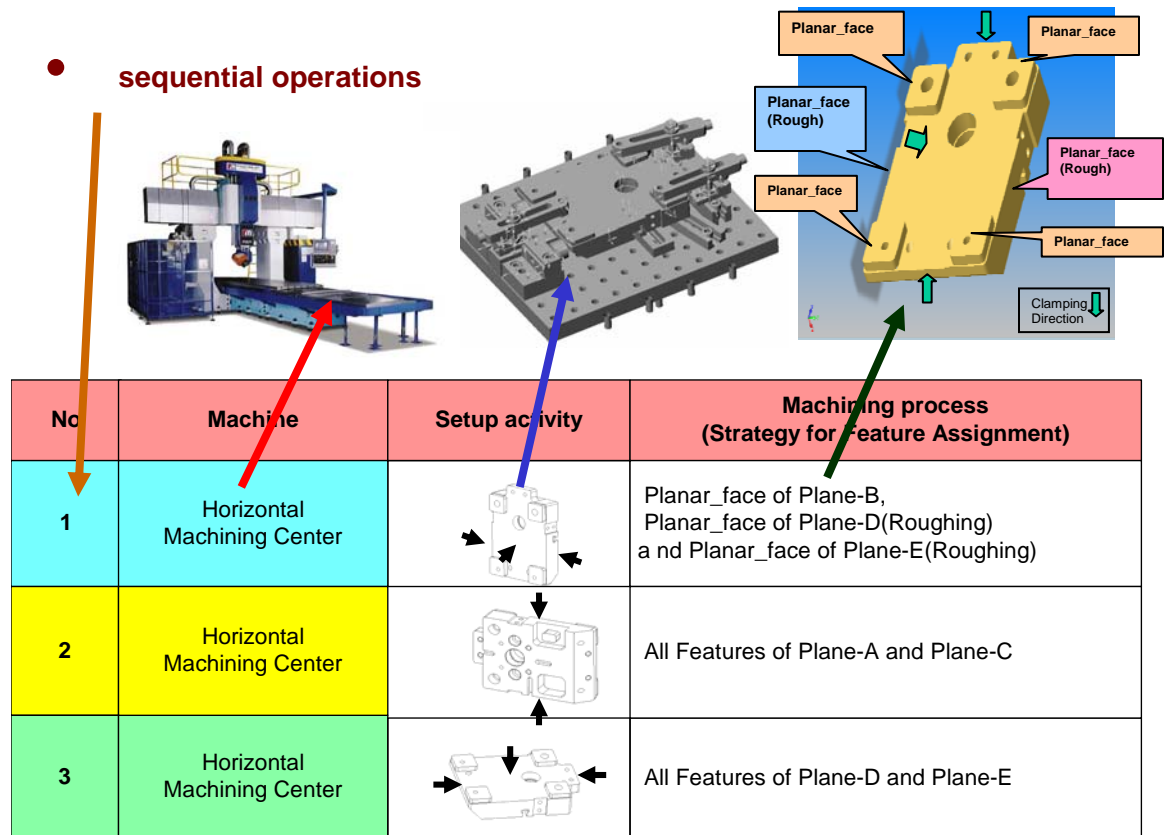
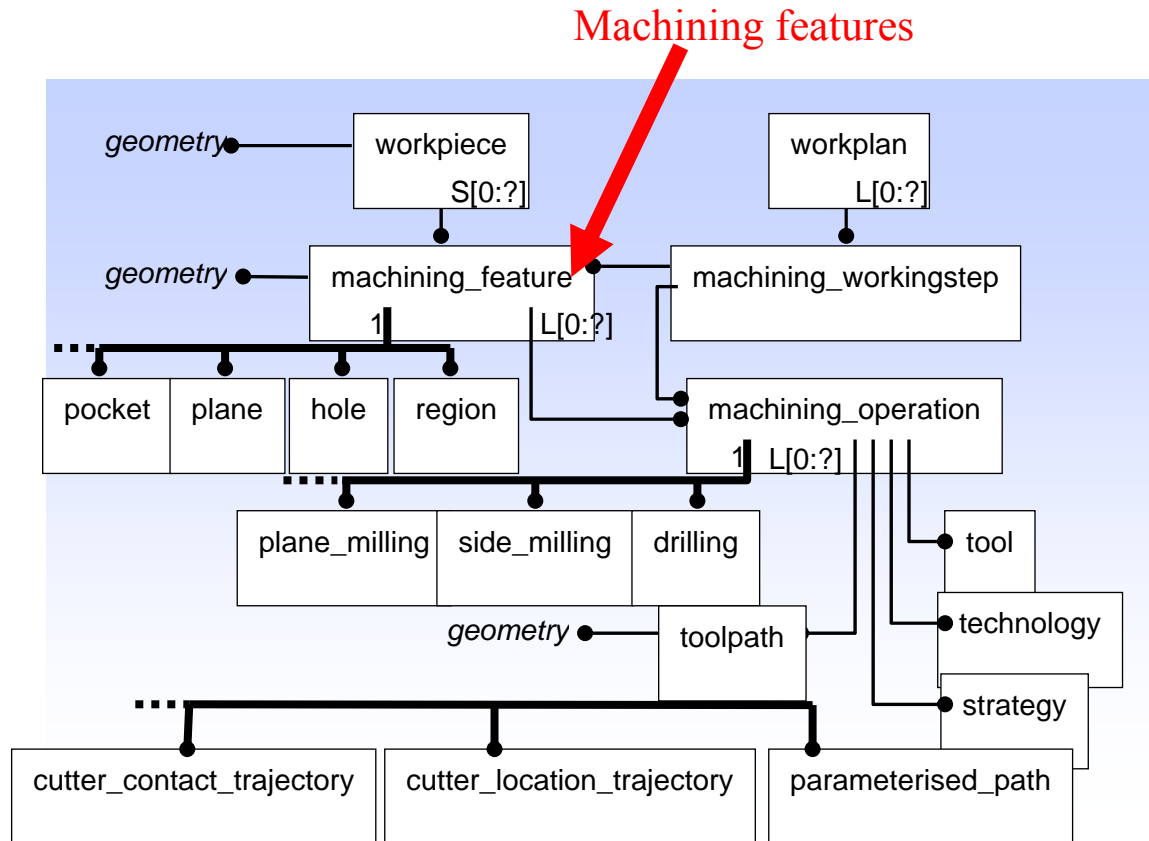

**Figure 9 — AP240**

### **Application interpreted model for computerized numerical controllers**

AP238 is the next step in manufacturing after AP240; this AP defines the micro process planning function (see Figure 10 – AP238). Where AP240 defined the high level details for manufacturing a part, this AP defines the specific controller information for a specific machine. This AP defines specific process information like boring, drilling, reaming or tapping. AP238 defines the setup, sequential working steps, cutting tool specifications for tools like drills, taps, boring tools, and reamers. AP238 describes how to make geometry from a piece of stock by removing metal volume defined as AP224 machining features in a sequential order with specific tolerances with tools that meet all engineering and design requirements.

AP238 may use the process plan output from AP240 and defines a machine work plan that contains a sequence of working steps, these working steps specify what machining feature is being machined. Each working step consists of a set of machining operations. These machining operations specify the specific operation like plane milling, drilling, etc., cutting tool, machining strategy, machining technology and the specific machining feature. Tool path geometry is created based on this machining feature.



**Figure 10 — AP238**

## Exchange of Design and Manufacturing Product Information for Cast Parts

AP223 defines product data to cover a broad range of life cycle data for the casting industry. This AP supports unique requirements specific for cast parts. Many times the “as designed” product data from the customer is not adequate to produce a cast part; therefore modifications to the “as designed” data must be made. The product data is modified to meet foundry specification, without affecting fit and function, of the part to be cast. The modified data is now the “as cast design” for the product data and must receive customer approval. The product data now contains additional information such as; draft angles, machining stock allowances, parting line assignments, surface finish specifications, and material property specifications if the “as designed” product data had not fully defined the material specification. From the “as cast design” product data, pattern tooling is fabricated and this tooling is used to form the mold cavity needed to produce the desired cast part for the customer.

Like AP224 and AP240, AP223 defines the “as designed” product data and process planning product data. This AP’s process plan defines activities and operations needed to support the casting foundry. AP223 also supports design information for the mold used to make the cast part. A variety of features, tooling, and terms unique to the casting process, e.g., cope, drag, sprue basin, runners, parting lines, etc are components of the molds for producing a cast part. Besides feature overlaps with existing APs, AP223 has additional requirements for simulation data, to simulate pouring molten metal into a mold cavity and analyzing the simulated cast part. The mold and casting are analyzed for cold shut, hot spots, high stress/strain areas, chill areas, vent placement, riser placement, pouring pressures, solidification

rates, and gating system for optimum metal flow. The machining features from the design shape become an integral part of castings in defining the cast shape and in developing the mold information.

To produce a cast part for a customer, the customer must either supply the pattern tooling to the foundry or the foundry, manufacturing the part, must provide the pattern tooling. In addition, the foundry must have available in-house the capability to produce the cast part. This would include; flask of correct size, molding machines, melts capacity, and testing equipment.

## **Machining features needed for Pattern Tooling**

Before a part can be cast, pattern tooling for that part must be constructed. Pattern tooling is defined as one or more patterns (cope and/or drag) on a parting medium with core boxes as required producing the cast part. AP223 uses the customer “as designed” product data as input data, to either the foundry or the pattern shop, to produce the “as cast design” product data for the cast part. The requirements for the cast part data are set to meet the foundry specification and best practice procedures for the foundry casting the part. The pattern tooling will embody most if not all the casting features for the casting. The term *casting* here is defined as the cast part and includes the gating, venting, and filtration systems. There must be a one to one relationship between each casting feature on the cast part that requires a machining operation at the machine shop and the machining feature in the “as designed” product data from the customer. In addition, there will be many instances where a casting feature will be identified, but within that casting feature there will be machining features defined in the “as designed” product data from the customer. An example is a drafted cast pocket with one or more countersunk holes in the bottom of the pocket but the holes are cast solid. In this case, at least drilling operations performed by a machine shop will be required.

## **Casting features**

AP223 uses the machining features to define the casting features. Features for castings have a different semantic definition as well as different requirements and for foundry practices a different set of features are required to augment a selected set of machining features. Casting features are listed in Figure 11 – Casting Features.

These features like machining features define a geometric shape for shapes used for metal casting, and they also add user terminology to the shape and a more implicit definition to the shape.

## **Machining features**

AP223 uses machining features to define the “as designed” part and also uses most of the machining features to define the “as cast design” product data. Although the names of the casting features may be different, AP240 maps the casting feature to the machining feature for the machine shop and the required machining operation. For example the casting feature “ear or lug” is really a combination of the “planar\_face” feature and the “step” features. Where the casting features and the machining features have the same name and semantics there is a one to one correspondence between the casting features and the machining features.

## **Dimensional Inspection Information Exchange**

This Application Protocol will specify the information requirements to manage dimensional inspection of solid parts or assemblies, which includes administering, planning, and executing dimensional inspection

as well as analyzing and archiving the results. Dimensional inspection can occur at any stage of the life cycle of a product where checking for conformance with a design specification is required.

Mold locks	Chill area
Boss	Core
Basin	Core print
Contact	Loose piece
Drafted surface	Vent
Parting surface	Pad
Chaplet	Rounded corner
Chill	Rib
Cope	Slot
Drag	Step
Ear/Lug	Runner
Fillet	Ingate
Filter/strainer	Feeder
Finish/machining allowance	Sprue
Hole	Riser
Pocket	Well
Gating system	
Ejector system	

**Figure 11 — AP223 Casting Features**

## **Inspection features**

AP219 uses machining features to define the “as designed” part, however for the purposes of dimensional inspection a different set of features are required. Features for inspection have a different semantic definition as well as different requirements. The product data from design and process planning use features that define the entire shape of a geometric area on a part, for example a hole. Dimensional inspection defines features that interrogate a machine feature in more detail. For example a machine hole feature will be represented by several dimensional inspection circle features. Each circle feature defines the area where measurement points shall be taken.

## **Machining\_feature**

AP219 uses machining features to define the “as designed” machining feature, and uses this information to create the inspection feature to define data “as inspected” This AP then defines the calculated values from the inspection and links this data to the “as designed feature” and the “as inspected feature” for analysis. Measurement results can be evaluated against the “as designed feature”.

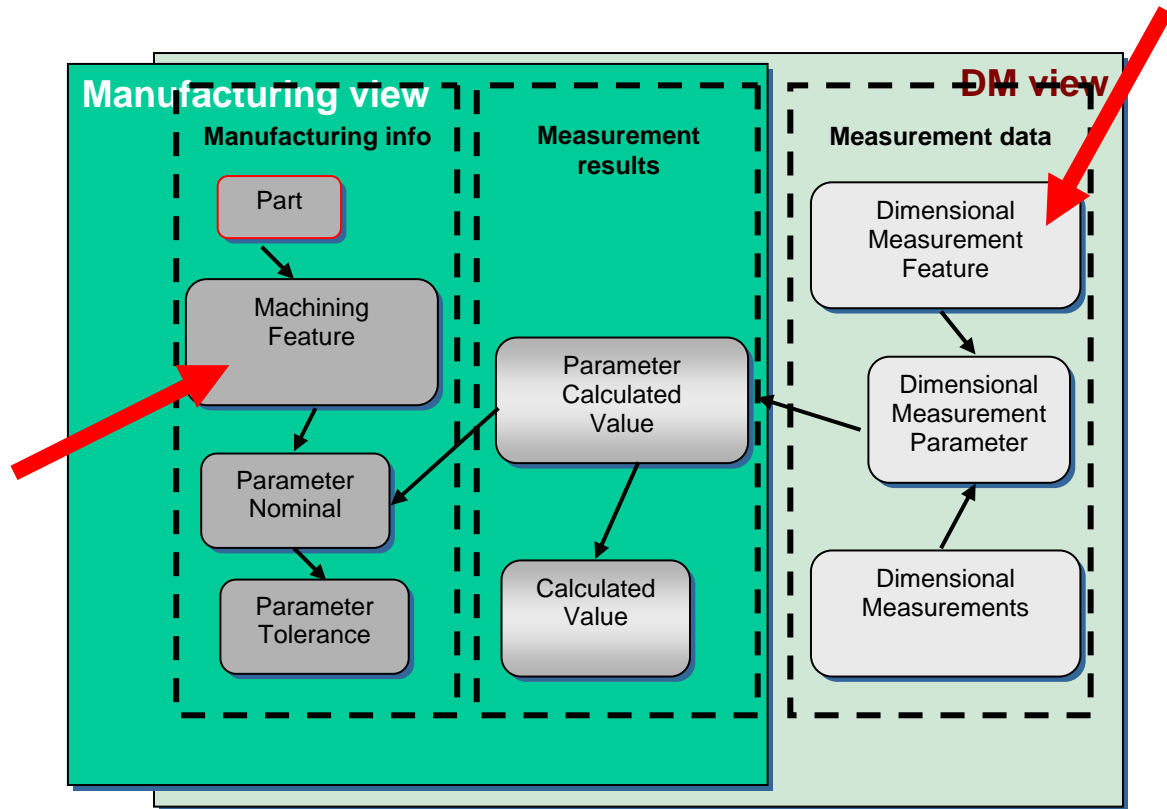

Figure 12 — AP219

## Conclusions

The architecture of all of the ISO 10303 manufacturing application protocols are tightly integrated around machining features. Whether a part is to be machined from a solid block of metal, bar stock, or from a casting the “as designed” product data should be represented in a neutral format that can be used or modified by multiple disciplines throughout the manufacturing process for a part. By using the neutral format of the machining features, these features may be tailored to meet the specific requirements for the manufacturing domain that need them. When a customer develops the design of a part using machining features and passes that design file to a machine shop, process planer, foundry, pattern shop, and inspection and these domains have ISO 10303 compliant software to use the product data files there will be little chance for error in meeting the form, fit, and function for the part. This paper has defined machining features and the use of these features across all of these APs. STEP driven manufacturing is based on machining feature driven manufacturing.

### STEP R&D Projects That Address Manufacturing

There are several on-going Research and Development (R&D) projects through out the world that are addressing STEP and Manufacturing.

- The Rapid Acquisition of Manufactured Parts (RAMP) Project began in 1986 addressing standards driven applications for the manufacture of mechanical and electrical parts and assemblies. Early versions of STEP AP224 were developed and implemented as a part of the RAMP Program. Standards driven applications were developed in an R&D environment and put

into production at DoD Depots and several commercial sites. This program was initially funded by the Naval Supply Systems Command (NAVSUP) and later by the Defense Logistics Agency (DLA).

- The TACOM NAC is the current sponsor of the Technology under DLA's Strategic Sourcing Technologies (SST) contract. Much of the work in the mechanical domain will be an integral part of the N-STEP Program under TACOM NAC (For more information, see Section 6 and visit <http://isg-scra.org/STEP/index.html> for a copy of The STEP Manufacturing Suite White Paper.)
- TACOM also sponsors the Army Ground Systems Industrial Lean Enterprise (AGILE) program, which is an R&D and implementation program that applies SCRA and STEP Tools, Inc. technology to improve U.S. Army industrial base operations at Depots and arsenals.
- The U.S. Army Armament Research Development and Engineering Center (ARDEC) sponsors the Lean Munitions program, implemented by SCRA and UTRS. This program applies STEP technology to the Armament and Munitions mission areas and includes R&D and implementation components.
- The UK RAMP Program is an implementation of the RAMP technology in the United Kingdom. This program has been in place since 1998 and is used in production. It is funded by the UK Ministry of Defence.
- The European Commission's STEP-NC Program is funded by ESPRIT. It is a highly visible Program with participants worldwide in Europe, the Far East and the United States. A primary objective of this program is the development and prove-out of the ISO 14649 standards as a replacement for ISO 6983:1982 and to eventually eliminate the use of the RS274D M- and G-codes for programming NC Controller. Participants include Industry, Universities and NC Tool Vendors. The Program started in January 1999 and will end in December 2001. (For more information, visit <http://www.step-nc.org>)
- STEP Tools, Inc's Super Model Project is the name given to the Model Driven Intelligent Control of Manufacturing Project and is funded under NIST's Advanced Technology Program (ATP). Its goal is to "utilize the STEP-NC and other standards in order to develop an open database of all the information necessary to design and manufacture apart. "Related to this project is STEP Tools, Inc's participation in the EC STEP-NC Project and their STEP-NC prototype demonstrations using STEP and ISO 14649 technology. (For more information visit <http://www.steptools.com>)
- The Intelligent Manufacturing Systems (IMS) Program is a worldwide consortium addressing many areas in the manufacturing domain. (For more information visit <http://www.ims.org>)
- The Rapid Response Manufacturing (RRM) Program was a National Center for Manufacturing Sciences (NCMS) program in the early 1990's funded initially by Defense Advanced Research Projects Agency (DARPA) and a later follow-on by NIST ATP. It had an objective of modeling manufacturing resource data.

## 2.9.2 Shipbuilding Suite

### ISO 10303 for Ship Product Model Data Exchange

The STEP development community is working to ensure these standards support international product model exchange requirements. The ship community is participating to ensure that their product model data can be exchanged to support real business processes. Integrated Resource parts in STEP address geometry, materials, tolerances, configuration management, and other general requirements. Application Protocol (APs) parts have been developed to address specific products and processes.

## Ship Step Standards

Almost every AP can be used by most industries. These are the key ship industry needs for product model data exchange using ISO 10303 STEP.

### System Standards

#### AP 233 - Systems Engineering Data Representation (In development)

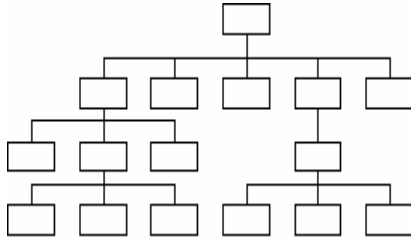

AP 233 addresses a need to exchange system requirements. The scope includes conformity to the concept of a system; configuration control; requirements, requirement analysis, and functional allocation/ analysis/ behaviour; and physical architecture.

#### AP 239 - Product Lifecycle Support (Published)

	<p>AP 239 addresses support of the system from concept to disposal. It enables you to: request, define, justify, approve, schedule and capture feedback on work activities/resources; document product requirements and configuration as-designed, as-built, and as-maintained; provide feedback on product properties, operating states, behaviour and usage; and define support opportunities, facilities, personnel, and organizations for the complete ship description of structural envelope, distributed systems, and the subsystems/equipment.</p>
--	--

**Ship Structural Envelope (hull forms, structures, arrangement)**

**Distribution Systems (electrical, piping, HVAC, cable trays, mechanical)**

**Mission Subsystems/Equipment (PLIB, RDL)**

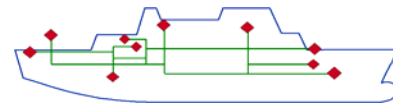

### Ship Structural Envelope Standards

This is some of the product model data that can be exchanged with the ISO 10303 ship STEP APs and ISO 13584 PLIB standards.



### **AP 215 - Ship arrangement (Published)**



AP 215:2004 supports the following activities: subdivision of ships into compartments and zones; volumetric capacity calculations; compartment connectivity/adjacency checking; stability calculation and spatial accessibility; area/volume reporting; tank capacities.

### **AP 216 - Ship moulded forms (Published)**

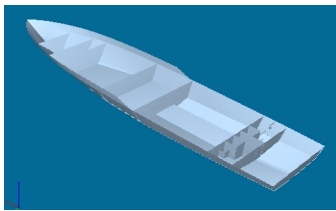

AP 216:2003 addresses principle hull moulded form dimensions and characteristics, internal compartment boundaries, appendages, hydrostatic properties, propellers and control surfaces.

### **AP 218 - Ship structures (Published)**

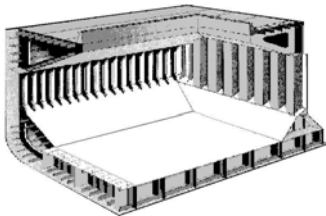

AP 218:2004 addresses transfer of data for shipbuilding activities and applications associated with design and early the stages of manufacturing such as: plates, stiffeners, profiles, assemblies, connectivity, welds, approvals, and change identification.

## Distribution Systems Standards

### AP 227 - Plant spatial configuration (Published)

AP 227:2005 is an ISO standard that addresses the spatial configuration of items in process plants and ships. AP 227:2001 supports the transfer of product definition necessary to support piping design in process plant facilities. Edition 2 adds HVAC and cable tray information and distributed system information such as: flow; sizing; stress; connectivity checks; system testing; interference detection; fabrication; assembly and installation instructions. Edition 2 also addresses mechanical systems, such as conveyor systems or a ship power train.

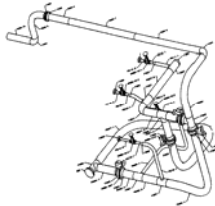

Piping

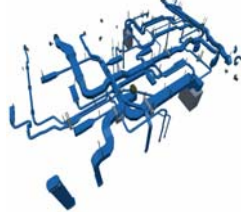

HVAC

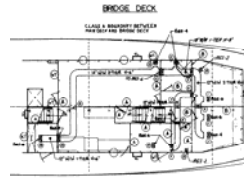

Cable Trays



Mechanical

### AP 212 - Electrotechnical design and installation (Published)

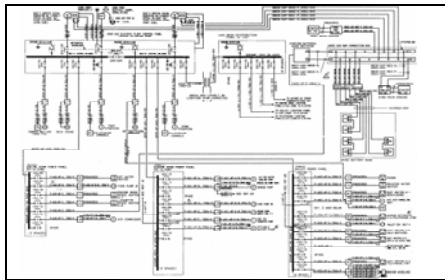

AP 212:2001 is an ISO standard that specifies information requirements for the exchange of design information of electrotechnical plants and industrial systems. Addresses the transfer of electrical product definition necessary to support electrical and cable tray: current analysis; equipment; lighting; cable sizing; electrical connectivity checks; and interference detection.

## Mission Subsystems/Equipment Standards

### ISO 13584 and 15926 for parts libraries and catalogs

Before the product model data exchange of a facility or ship can take place we need to complete a successful exchange of the components pieces that make the assembly. For this reason T 23 is also participating in two alternatives for parts library exchanges. We intend to be able to support both approaches to exchanging part catalog information.

### AP 214 - Core data for automotive mechanical design processes (Published)

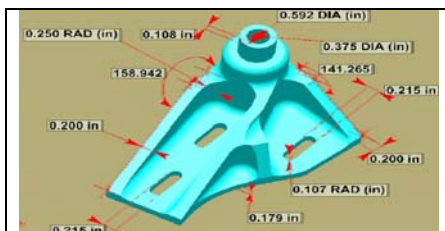

AP 214:2001 is used to exchange mechanical geometry, product structure, configuration management, assemblies, supplier, tolerances and other information. It includes drawing exchange ensuring that a complete manufacturing technical data package can be exchanged.

## Summary

Geometry is just one aspect of the product that needs to be shared and archived. The STEP APs capture additional data on components and systems to improve sharing of important ship information. Additional information is at:

ISO Catalog - <http://www.iso.org/iso/en/CatalogueListPage.CatalogueList/>  
ISO TC 184/SC 4/WG 3/T 23 (Ship team) - <http://www.nsrp.org/t23/>  
ANSI Catalog - <http://webstore.ansi.org/ansidocstore/default.asp/>  
US National Shipbuilding Research Program - <http://www.nsrp.org/>  
Europe Marine e-business Standards Association - <http://www.emsa.org/>  
Japan Ship Technology Research Association (JSTRA) - <http://www.jstra.jp/>  
Korea STEP Center - <http://kstep.or.kr/>  
PDES, Inc. - <http://pdesinc.aticorp.org/>

## 2.9.3 Eletromechanical Suite

### ISO 10303 for Electromechanical Product Model Data Exchange

The STEP development community is working to ensure these standards support international product model exchange requirements. The electronics community is participating to ensure that their product model data can be exchanged to support real business processes. Integrated Resource parts in STEP address geometry, materials, tolerances, configuration management, product data management, and other general requirements. Application Protocol (APs) parts have been developed to address specific products and processes.

### ELECTROMECHANICAL STEP STANDARDS

Almost every AP can be used by most industries and for most products. These are the key electronics industry needs for product model data exchange using ISO 10303 STEP. Also the APs below can be used in multiple life cycle phases. For example AP 210 can classify requirements according to life cycle and domain context, supports declarations, inputs/outputs, and simulation libraries for analysis processes, supports design and Bill of materials, and provides manufacturing/inspection data for printed wiring/circuit boards.

### Generic Standards

#### **AP 203 - Configuration controlled 3D designs of mechanical parts and assemblies (Published)**

AP 203 is used to exchange geometry, product structure, and configuration management data. Edition 2 adds tolerances, construction history, layers and colors to the 3D exchanges with ISO 10303 re-usable data modules.

## System Standards

### AP 233 - Systems engineering data representation (In development)

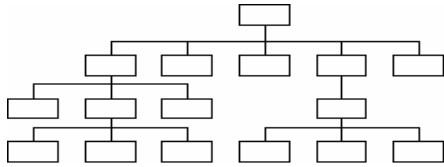

AP 233 addresses the need to exchange system requirements. The scope includes: conformity to the concept of a system; configuration control; requirements, requirement analysis; and functional allocation/ analysis/ behaviour; and physical architecture.

### AP 232 - Technical data packaging: core information and exchange (Published)

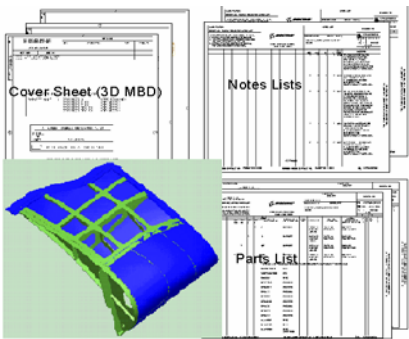

AP 232 provides the structure to package/relate groups of product information so that configuration controlled exchanges can be achieved. Product information may be exchanged in this AP's STEP format, another AP STEP format, or any other format. This capability will satisfy the industrial need to communicate and share the total design definition of a product among originating organization, partners, vendors, and customers from both a product item perspective and a document based perspective.

### AP 239 - Product Lifecycle Support (Published)

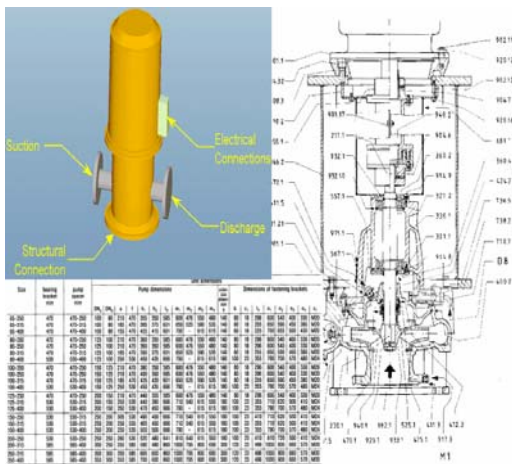

AP 239 addresses support of the system from concept to disposal. It enables you to: request, define, justify, approve, schedule and capture feedback on work activities/resources; document product requirements and configuration as-designed, as-built, and as-maintained; provide feedback on product properties, operating states, behaviour and usage; and define support opportunities, facilities, personnel, and organizations for the complete ship description of structural envelope, distributed systems, and the subsystems/equipment.

## Electrical Standards

### AP 210 - Electronic assembly, interconnect and packaging design (Published)

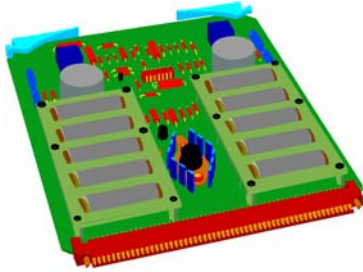

AP210 specifies the data for electromechanical design process. It includes specific data needed to support multi-level hierarchical design of electrical modules including both electrical and mechanical (structural/thermal) aspects of the design. Multiple levels of fidelity are supported by the physical models. A completely neutral electrical/mechanical component library is supported. Detailed layout structures and features are supported for 2D and 3D interconnect, including OEM and Fabricator views.

### AP 212 - Electrotechnical design and installation (Published)

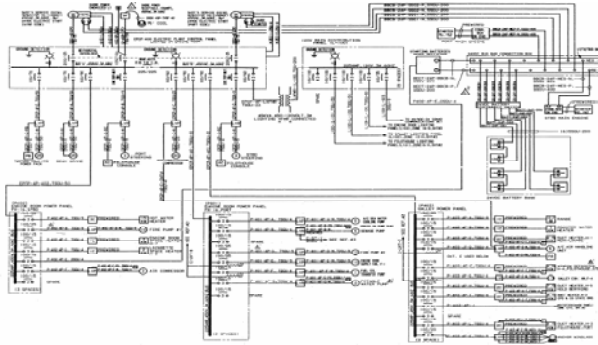

AP 212 is a STEP exchange standard that specifies data representation for electrotechnical plants and industrial systems design information. It addresses electrical product definition necessary to support electrical and cable tray: current analysis; equipment; lighting; cable sizing; electrical connectivity checks; and cable tray interference detection.

## Mechanical Standards

### AP 209 - Composite and metal structural analysis and related design (Published)

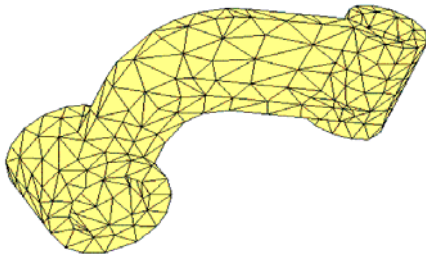

AP 209 specifies computer-interpretable composite and metallic structural product definition data representation such as: shape, idealized analysis shape, finite element analysis (FEA) model, analysis results, and material properties. The design and related analysis information are managed within a PDM product structure.

## AP 214 - Core data for automotive mechanical design processes (Published)

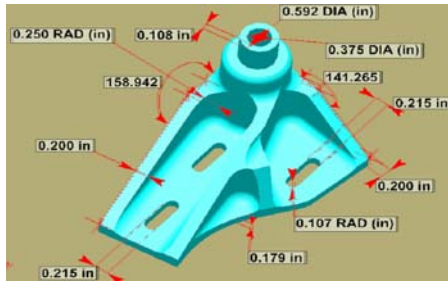

AP 214 is used to exchange mechanical geometry, product structure, configuration management, assemblies, supplier, tolerances and other information. It includes drawing exchange ensuring that a complete manufacturing technical data package can be exchanged.

## AP 219 - Dimensional Inspection (In development)

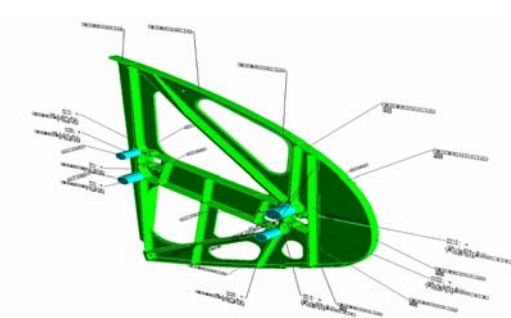

AP 219 will specify information requirements to manage dimensional inspection of solid parts or assemblies, which includes administering, planning, and executing dimensional inspection as well as analyzing and archiving the results. Dimensional inspection can occur at any stage of the life cycle of a product where checking for conformance with a design specification is required.

## Component Standards

### ISO 13584 Parts libraries and catalogs (PLIB) (Published)

PLIB supports exchange of parts catalogue information between external vendors and internal engineering and procurement parts libraries.

### Summary

Geometry is just one aspect of the product that needs to be shared and archived. The STEP APs capture additional data on components and systems to improve sharing of important aerospace information. Additional information on ISO 10303 parts is at:

ISO TC 184/SC 4 On-Line Information Service for STEP and PLIB - <http://www.tc184-sc4.org/>

ISO Catalog - <http://www.iso.org/iso/en/CatalogueListPage.CatalogueList>

ANSI Catalog - <http://webstore.ansi.org/ansidocstore/default.asp/>

PDES, Inc. - <http://pdesinc.aticorp.org/>

ProSTEP iViP Association - <http://www.prostep.org/en/>

Product Lifecycle Support, Inc. - <http://www.plcsinc.org/>

## 2.9.4 Process Plant Suite

NIST has had a leadership role in developing the Process Plant (and Architecture, Engineering and Construction (AEC)) AP's with extensive international cooperation and participation

The primary AP's for Process Plants are AP's 221, 227, and 231. The primary AEC AP (to date) has been AP225.

AP221 (CD) - Functional data and their schematic representation for process plant (See 2.7.7)- This AP addresses functional data and some physical data for plant items and systems. Within the scope are schematics (e.g., P&ID and data sheets); standard data for piping, valves, vessels, instrumentation and some equipment; and data repository concepts.

<http://www.btinternet.com/~Chris.Angus/epistle/standards/ap221.html>

“AP221 was balloted and approved as an ISO Committee Draft in 1997. Subsequent development has been delayed by the need for harmonization with the POSC Caesar product model. This harmonization work was carried out by the EPISTLE Data Modelling Group, consisting of experts nominated by PISTEP, POSC Caesar, and USPI-NL. The Data Modelling Group produced the EPISTLE Core Model version 3 and ISO/CD 15926-2 as interim deliverables of this harmonization process and the EPISTLE Core Model version 4 as the final deliverable. Version 4 is being published for international balloting as ISO/DIS 15926-2 and forms the basis for the Application Reference Model of the Draft International Standard version of AP221. The Draft International Standard of AP221 is expected to be completed and published before the end of 2001. This will make use of STEP application modules; a draft version of the modular form of AP221 was presented at the ISO TC184/SC4 and WGs meeting in San Francisco (June 2001).”

ISO 18876-1 Architecture overview and description

ISO 18876-2 Integration and mapping methodology

**AP227 (IS)- Plant spatial configuration** - (See 2.6.15 ) - The emphasis of this AP is on piping design. It includes physical and functional characteristics and references to specifications and stream design cases.

**AP231 (CD)- Process design and process specifications of major equipment** - The scope of this AP includes process simulation, unit operations, and the conceptual design of major process equipment. (Currently Inactive)

### **& Related AP's:**

**AP212 (IS)- Electrotechnical design and installation** - IS (See 2.6.8 )

**AP225 (IS)- Building elements using explicit shape representation** – (AEC)(See 2.6.14 )

**AP228 - Building services: heating, ventilation, and air conditioning** - (AEC) Withdrawn

**AP230 - Building structural frame: steelwork** - (AEC) Withdrawn due to lack of resources - (AP230: Building structural frames: Steelworks. The baseline for AP230 development is CIS - the CIMsteel Integration Standards, developed by the Eureka 130 CIMsteel project. A simplified version of CIS/AP230 is being adopted in Finland by the SteelBase project.)

### **Projects/Prototype Implementations (with AP's addressed):**

- EPISTLE - European Process Industries STEP Technical Liaison Executive (AP221)
- POSC/Caesar - development of "STEP-like" standards in the oil and petrochemical industries
- SPI-NL - Standard for Plant Information in the NetherLands
- pdXi - process data eXchange institute (AP231)
- PlantSTEP - (NIST, Bentley, Dassault, Intergraph) (AP227)

- PIEBASE - Process Industry Executive for achieving Business Advantage using Standards for data Exchange (AP221, AP227, AP231)
- ProcessBase - (ESPRIT)- (AP221)
- PIPPIN - The PIPPIN Project (Pilot Implementation of Process Plant Information warehouse) is a collaborative project under the EC's ESPRIT IV programme. The partners include BP, Brown and Root, EuroSTEP, Framatome, ICI, ICS, Shell and Quillion. The project objective is to build a STEP compliant data warehouse for process plant engineering data using the STEP (ISO 10303) Standard.
- PISTEP is a consortium of UK companies in the process industries. It aims to increase the competitiveness of the UK process industry by improving engineering information management throughout the lifecycle and the supply chain. This is being achieved by the use of information technology and international standards.
- Eureka CIMsteel Project (AP230) (AEC & Process Plant) – 40+ collaborators in eight countries (Austria, Denmark, Finland, France, Italy, the Netherlands, Sweden & the UK)

## **2.9.5 Systems Engineering Suite**

### **AP233 Systems Engineering Intent**

Provide support for data transfer among tools:

- For the System Project Management and the System Specification and Design
- For the system specification and design to optimize it to the marketplace.
- For information exchanges between system stakeholders
- Over the full system life cycle from concept through disposal.
- Interoperable with other ISO/SC4 engineering discipline standards.

#### **Scope: System Project Management**

- PDM Capabilities
- Work Breakdown
- Organization, Persons, and Qualifications
- Work Assignments
- Schedules
- Resources
- Approvals
- Effectivity Management

#### **Scope: System Specification and Design**

- System Specification and Design over the full system life cycle from concept through disposal.
- Derivation of Requirements and Trade Optimization Criteria (MOE's) from Stakeholder Needs and Business Strategy
- Traceability of Requirements and MOE's and their allocation to Models
- Trade Studies
- Behavior Models (response to excitation)
- Structure Models ( parts lists and interface definitions/descriptions)
- Performance Models (required physical parameter values like weight or MTBF)



- Interface to Analysis Tools (all views of analysis used for decision making. Includes requests for analysis and the delivery of results )
- Verification & Validation
- Interoperability with other ISO/Sc4 engineering discipline design tool standards

**Scope: Interface Between - System Project Management & System Specification and Design**

- Issue Tracking & Resolution
- Risk Analysis
- Configuration Management
- Reviews and Documentation
- Engineering Change Requests, ECR's

**Out-of-Scope:**

- Engineering Detail Design (i.e. mechanical, electrical, ship building)
- Manufacturing Detail Design
- Software Design and Coding
- Analysis itself (i.e. finite element calculation details)
- General Management of Businesses

**System Project Management Work  
is Concurrent in time with  
System Specification and Design Work**

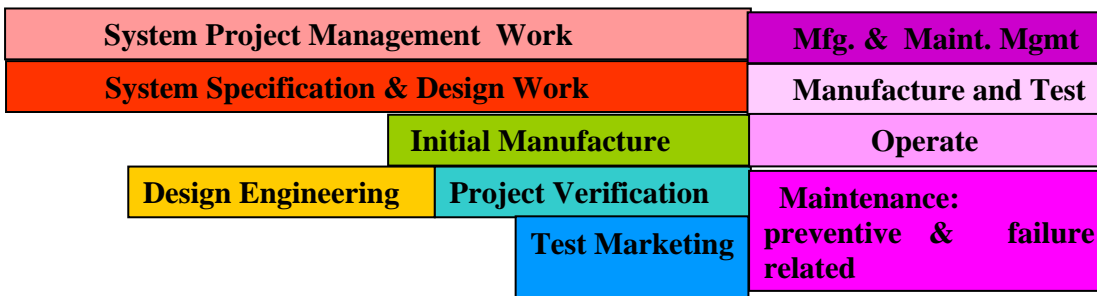
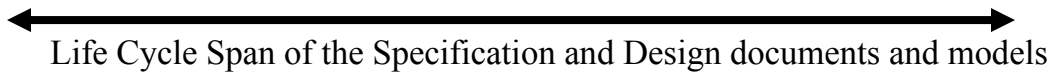

**Figure 13 — System Project Management**

The Specification and Design documents and models span the whole life cycle. System Project Management work continues until the project is verified against requirements and validated with stakeholders, perhaps by Test Marketing. System Specification and Design work continues through the technical aspects of Verification.

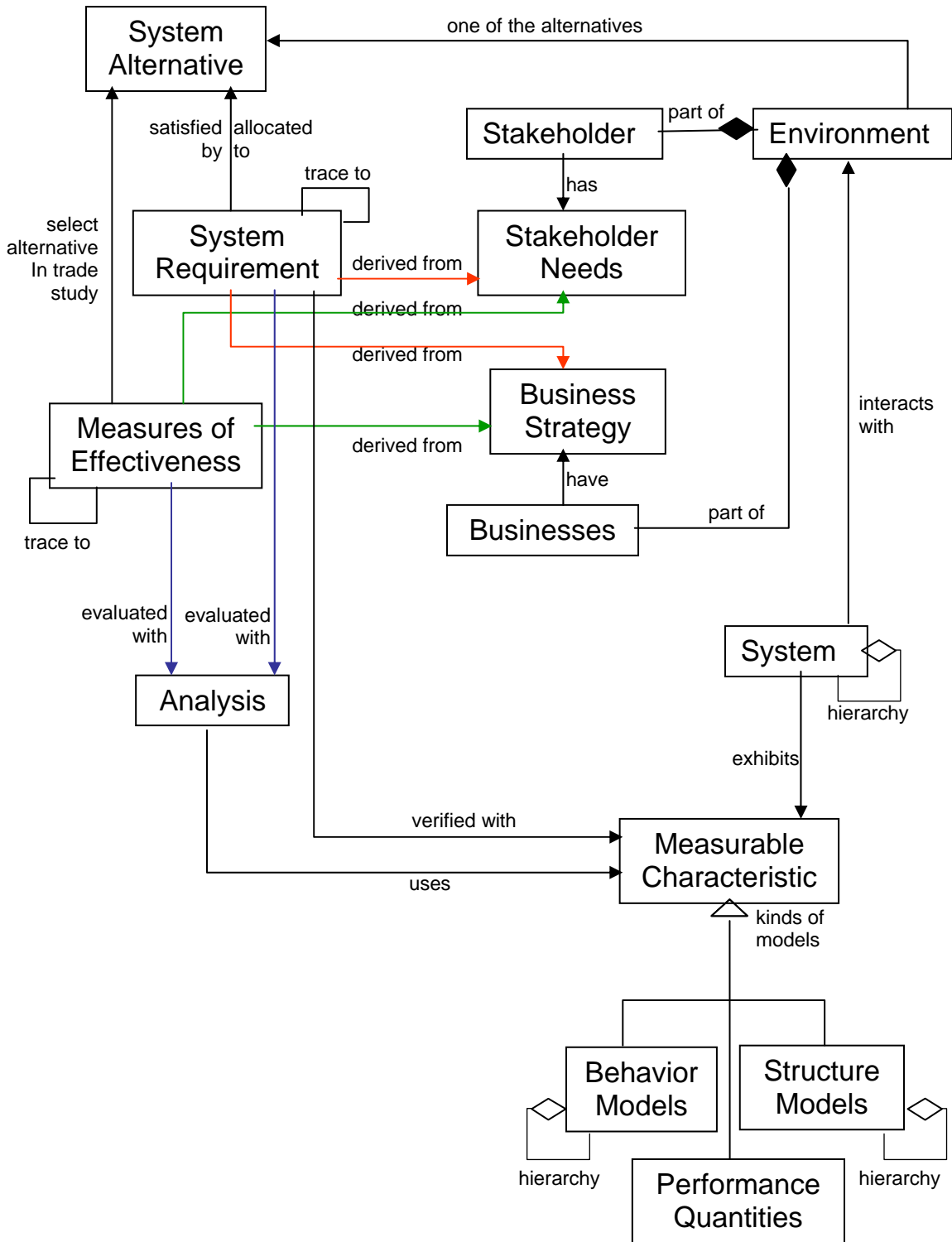

**Figure 14 — Conceptual Data Model for System Specification & Design**

## Description of the Conceptual Data Model

The System is hierarchical; it is built from smaller systems (called variously sub-systems, components, or parts).

The System interacts with its Environment and is defined by what is inside, what is outside, and what happens at the boundary.

The Environment contains Stakeholders who may be owners, users, operators, maintainers, outside physical characteristics, etc.

The stakeholders have needs that the system must meet if it is to succeed in the marketplace.

The Environment contains both our Business and competitor Businesses

Requirements are derived from stakeholder needs and the business strategy (see red lines). The System shall meet the requirements, but there may be many possible solutions.

Optimization criteria (MOE's) for trade studies are derived from stakeholder needs and business strategy (see green lines).

Example: the MOE's for a laptop might be long battery life, light weight, and least thickness provided these are the parameters customers will actually use to choose in the market place. Sales are optimized by optimizing these trade study parameters that the purchasers will apply in their personal buy decision.

The System, when it is built, has Measurable Characteristics. One wants these to correspond with what was written in the requirements and MOE's, and contained in any models of the System.

The Measurable Characteristics include:

- Response to excitations or **Behavior**
- The parts or subsystems that comprise the System and how they interconnect or **Structure**
- The **Performance Quantities** (with units, values, and variances) that the System hierarchy exhibits.

Analysis uses the Performance Properties as parameters to calculate the characteristics of the whole from those of the parts.

Verification consists of measurement of the Measurable Characteristics and comparison with the values that appear in the Requirements. It is proof that one built what was specified.

### 2.9.6 Engineering Analysis Core Model

The following information is from [The Engineering Analysis Core Model – A ‘plain man’s guide’ \(See Document 20 in Appendix A and \[http://pdesinc.aticorp.org/eacm\\\_plainmansguide.doc\]\(http://pdesinc.aticorp.org/eacm\_plainmansguide.doc\) \(PDES Inc.’s Public Website – STEP Capabilities – Engineering Analysis\)\)](#)

“(T)he Engineering Analysis Core Model (EACM) ... defines the architecture of systems for engineering analysis information, and the interfaces between them.

The EACM is concerned with management issues, including:

- the versioning and configuration management of engineering analysis data;
- the archiving and exchange of engineering analysis data; and
- the audit trail links between engineering analysis data and the processes that create them.

The EACM is also concerned with technical issues, including:

- the storage of the definition of an engineering problem as well as the details of a particular approach to its solution;

- the transfer of information between different disciplines (e.g. structural, CFD (Computational Fluid Dynamics), thermal) and between different representations (e.g. different meshes - structured and unstructured, h-refinement and p-refinement); and
- the use of test data in analysis.”

“The EACM has three key aspects:

- the management of engineering analysis information alongside all other information concerned with the design of a product ...;
- the linking of all engineering information to the activity that created it, whether a design decision, analysis calculation or test ...; and
- the holding of information about the properties of a product, including fields that vary with respect to space and time, in a form that can be used by any system for any calculation ...

These three aspects taken together mean that the EACM is a bridge between three different worlds:

- CAD and PDM, where systems for managing the design process have developed from Drawing Office Registries;
- the workflow and project management, where concerns range from time sheets at one end to the auditing of a certification process at the other;
- leading edge analyses, with problems such as the transfer of information from a finite difference CFD code to a p-refinement structural code.”

“The EACM consists of modules that provide capabilities as follows:

- the data management of information about a product, its environment and its usage scenarios (This capability is provided by interfaces to the PDM modules...);
- the definition of the properties of a product - as they exist for a particular state of the product, and as they vary during a particular usage of the product;
- audit trails for the source of property information, and indicators for the quality of property information;
- a range of mathematical techniques for the description of properties that are fields varying with respect to position or time - these include descriptions with respect to structured and unstructured analysis meshes, and with respect to the parameter spaces used for product geometry.”

The initial EACM STEP Parts are described in the NWI for Fluid Dynamics. The parts were registered with ISO as AWI's in August 2001. The documents can be referenced at: [http://www.nist.gov/sc4/nwi\\_pwi/nwi/step/fluid\\_dyn/doc](http://www.nist.gov/sc4/nwi_pwi/nwi/step/fluid_dyn/doc)

The new work item defines a standard for the sharing, exchange, and storage of fluid dynamics data. The information within scope will include digital flow field data, surface data, and integrated data from three types of sources: (1) analysis and computation, (2) ground test (e.g., wind tunnel test), and (3) flight test. The first edition will focus on data related to analysis and computation. and consists of the following four parts (See 2.8.17):

- 10303-237, Application Protocol: Computational fluid dynamics
- 10303-110, Integrated Application Resource: Computational fluid dynamics data
- 10303-52, Integrated Resource: Mesh-based topology
- 10303-53, Integrated Resource: Numerical analysis

The EACM Suite supplements and expands upon AP209 which is already an International Standard (See 2.6.5)

## 2.9.7 Product Life Cycle Support (PLCS)

### 2.10 Overview

Product Life Cycle Support (PLCS) is an ISO STEP standard (ISO 10303-239) that enables the creation and management through time of an Assured set of Product and Support Information (APSI) which can be used to specify and control required support activities throughout a complex product's life.

ISO 10303-239 provides an application-specific, but flexible, information model as part of the ISO STEP series of standards. The information model can be tailored by industry and organizations through the use of Reference Data Libraries (RDL). The role of RDL is to complete the semantics of the PLCS model necessary for deployment in industry.

The benefit of ISO 10303-239 (PLCS) is its integrated view. However this means that it has a large and generic information model that is larger in scope than most business processes require or most IT applications can manage. This problem is addressed by defining "Data EXchange Set (DEX)"

### 2.11 Data EXchange Sets (DEX)

A DEX is a way of dividing up the ISO 10303-239 (PLCS) information model into sections suited for a particular business process. A DEX provides a subset of the PLCS information model and usage guidance. A DEX can be used to contract against or for setting conformance but AP239 implementations do not have to use DEXs.

ISO 10303-239 (PLCS) has been published as an ISO standard. The DEXs are initially being standardised by publishing the subset of ISO 10303-239 (PLCS) and associated usage guidance material as OASIS standards. Once they have been used extensively, they will be included as conformance classes of ISO 10303-239.

### 2.12 The contents of a DEX

Each DEX is comprised of

- Introduction;
- Business process;
- A description of the business process that the DEX is supporting;
- Identification of the process in the AP239 activity model supported;
- Usage guidance for the model;
- DEX specific Reference Data;
- The subset of the Information model supported by the DEX;
- EXPRESS information model;
- XML Schema (derived from the EXPRESS);

There are a number of parts of the PLCS model that will be common to many DEXs. (e.g. date and time). Rather than each DEX replicating the usage guidance for these, they are packaged into chapters called "Capabilities" that are reused across different DEXs.

## 2.13 Current set of DEXs

### **D001 - Product Breakdown for support**

Exchange of the relationship of the parts assembly structure, derived from a PDM system, to an LSI/LCN structure used to manage support, and the links to relevant documents

### **D002 - Faults related to product structures**

Exchanges the output from Fault Analysis programs in a form that can be used to identify required diagnostic and maintenance tasks, and to provide coherent fault reporting

### **D003 - Task Set**

Exchange of a set of task descriptions, to support a work plan, or for use in multiple support solution definition.

### **D004 - Work Package Definition**

Exchange and negotiation of a work package for a specific support opportunity including the list of required tasks, location, dates, products and resources.

### **D005 - Maintenance plan**

Exchange for defining and communicating the work required to sustain a product over time including the results of any Logistic Support Analysis.

### **D007 - Operational Feedback**

The exchange of the observed configuration, location, state or properties of an actual product, and the communication of work requests to resolve issues arising from feedback on its usage

### **D008 - Product as Individual**

Exchange and collation of manufacturing and serialised part information and its relationship to the product assembly structure from which it derived.

### **D009 - Work Package Report**

The exchange to support the reporting of work completion against a work package definition.

### **D010 - System requirements**

The exchange of requirements information related to a system.

## 2.14 Background to PLCS Inc

PLCS Inc (product life-cycle support) was an international consortia established to develop an ISO standard (ISO 10303-239). The consortia comprised: US Department of Defence, UK Ministry of Defence, Finnish Defence Forces, Norwegian Ministry of Defence, FMV (Swedish Ministry of defence), DNV, Boeing, BAE SYSTEMS, Rolls Royce, Lockheed Martin, SAAB, Hagglunds Vehicles, BAAN, LSC, PTC, Aerosystems International, and Pennant. Eurostep Limited provided the technical leadership and programme management for the consortia.

## 2.15 PLCS OASIS Technical Subcommittee

Having delivered ISO 10303-239 as a Draft International standard the consortia disbanded. The future development of PLCS is being coordinated by the OASIS Product Life Cycle Support (PLCS) Technical Committee.

## 2.16 Sponsors

The creation of the website was a joint effort between Eurostep and the UK Ministry of Defence Product Data Standards team. (see <http://www.plcs-resources.org/>)

## The Product Life Cycle Support (PLCS) Initiative

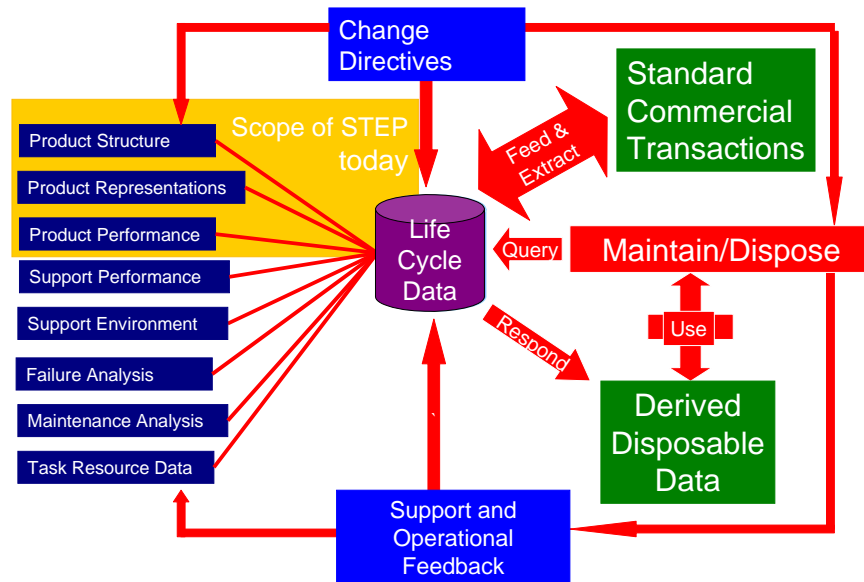

Figure 15 — Product Life Cycle Support

### 2.16.1 funSTEP

#### Confronting an industrial problem

The funStep Interest Group targets the interoperability among software solutions whatever the place they are used within the company and/or in different companies.

One of the main aims of the industry is to safeguard the investment in information technology, training and data management, making more profitable the investments in computer aided design, electronic commerce, and other related technology.

The funStep-IG brings together software vendors, manufacturers, retailers and technology developers in a single forum towards the adoption of common standards for interoperability.

#### Objectives

- Spread the knowledge and promote the use of product data standards within the furniture industry.
- Manage the evolution of the funStep standard.
- Co-ordinate working groups.
- Influence on the software implementations.
- Promote the adoption of results by standardization bodies.

#### Organization profile

- Non-for-profit organization.
- Not devoted to software development.
- Industry requirements based. Bottom-up approach. Early implementation oriented.

- Membership open world-wide to software vendors, industry, retailers and other furniture-related organizations.
- Open to collaboration with other working groups and standardization bodies.

## **funSTEP AP**

### **Objectives**

The funStep-AP project main aim is to accelerate the formal standardization process of the sectorial application protocol for product data exchange in the furniture industry, and to plan the required implementation efforts towards the development of interoperable software products to be adapted to the new emerging standard. The target users are the software vendors with interests in the furniture industry (and secondarily in the AEC sectors) In a second step, the targets are furniture manufacturers and retailers that use Computer aided design systems for furnishing, or at least product cataloguing software. The funStep-AP project under the ECOM-IS programme will take the responsibility of leading the industrial team to generate specific contributions for the official standardization initiatives. The special contribution to the CEN/ISSS and European standardization bodies will help in the generation of a single European position in front of the international standardization initiatives, as those within ISO TC184/SC4, very related to the project objectives. The duration of the project is planned to be 15 months, since the standardization process takes between 3 and 5 years.

The main funStep-AP project objectives are:

- To generate specific contributions to the product data exchange standardization process from the industrial point of view.
- To disseminate results within the industrial sector.
- To plan and take the initial steps towards the implementation by the software vendors

Due to the limited budget, the specific tasks for the software implementation, development of test cases and round table testings organization will be organized in a future project, with expected increased participation from software vendors. The funStep-AP development project will run in parallel to the Workshop CEN/ISSS Workshop "Data Exchange in Furniture" and will co-ordinate a significant set of end users, software implementors and experts in Product Data Technology in order to ensure the quality of contributions to CEN/ISSS.

### **Project**

The funStep-AP development project shall:

- Develop data models to support data exchange in furniture industry;
- Contribute to the Workshop discussion with industrial requirements;
- Adopt CEN/ISSS Workshop recommendations;
- Plan software implementation of the proposed standards and generate recommendations from the point of view of the industrial implementation;
- Develop a web site for round table testings and interoperability testings.

For more information on the concept and architecture of funSTEP, visit the following web site:  
<http://www.funstep.org/funStep.htm>



### 3 Other Product Data Exchange Specifications & Standard

Other "de facto", national, international product data exchange (PDE) standards exist and have been widely implemented. Many were originally developed to address 2D draughting (e.g., IGES, SET, VDA, DXF, DWG). Others such as EDIF, IPC, and Gerber were developed to address "point" solutions for different aspects of the Electrical/Electronic design process (e.g., schematic, netlist, photo plot, etc).

There are certainly instances where these PDE solutions are appropriate. There are other instances where perhaps direct translation is most appropriate. Most of the major vendors provide multiple PDE solutions/tools, and some provide PDE translation services. Several web sites are cited for further discussion on the use of other PDE formats.

This section identifies most of the "popular" PDE specifications and standards and provides a table of Vendor STEP and other PDE capabilities. There is also some discussion about direct translators, translation service centers, STEP tools, and solids modeling kernels for some of the major CAD/CAM systems.

#### **Other PDE Standards:**

IGES - Initial Graphics Exchange Specification --- ANSI Standard (Latest Version 5.3 - 1997) - Initially (ANSI Y14.26M-1981) addressed 2D and 3D drawing data, later added Solid Model data (CSG & B-Rep), Piping, Drafting and Electrical Subsets/Application Protocols also now exist. (Virtually, every CAD/CAM vendor has an IGES translator for their system.)

SLC - Rapid Prototyping - Stereolithography - 3D Contour based data format

STL - (3D Systems, Inc.'s Stereolithography Interface Specification (SIS) - Public Domain) - 3D vectorized/triangulated data - Widely used "de facto" industry standard.

DXF - (AutoDesk/AutoCAD Proprietary - Public Domain) - Widely used "de facto" industry standard.

DWG - (AutoDesk/AutoCAD Proprietary - Public Domain) - Widely used "de facto" industry standard.

ACIS (.sat) - (Spatial Technologies Proprietary - Public Domain) - A Solid Modeling System developed and marketed by Spatial Technology, Inc. - ACIS is the solid modeling kernel for numerous commercial CAD systems (e.g., AutoCAD, Mechanical Desktop, CADKEY, IronCAD, ...) "It supports 3D surfaces and solids and is based upon NURBS and B-rep solid modelling."

ParaSolid (.xmt, .x\_t, eXT) - (UGSolutions - Proprietary) - A Solid Modeling System developed and marketed by Unigraphics Solutions - Parasolid is the solid modeling kernel for numerous commercial CAD systems (e.g., Unigraphics, SolidEdge, SolidWorks, ...) "It supports 3D surfaces and solids and is based upon NURBS and B-rep solid modelling technology."

**VDA** - Verband der Deutsche Automobilindustrie - German DIN Standard

**VDA-IS (1.0)** - "IGES Specification - A subset (primarily for the exchange of drawings) of IGES used in the German Automotive Industry (DIN 66 301) - "standard to exchange two-dimensional basic CAD geometry and dimensions."

**VDA-FS (2.0)** - VDA/Flachen Schnittstelle- "neutral format for exchanging surface data between different CAD systems. Developed in Germany by VDA." (Includes/addresses trimmed surfaces)

**SET** - Standard d'Exchange et de Transfert - French AFNOR Standard (Z68-300) - Initially (1985) - Very much like IGES in content with a different, more efficient file structure. Has added coverage of Finite Element Modeling (FEM), Numerical Control (NC) and Solid

Modeling (CSG, Advanced B-Rep, and Facetted (polyhedral) B-Rep) - Developed by Aerospatiale. Maintained by GOSET.

**JEDMICS** - U.S DoD repository for archiving Technical Data Packages - They are primarily stored in CCITT Group 4 Raster format, but JEDMICS is capable of storing virtually any format.

There is a useful discussion on IGES/SET/VDA and STEP at the following websites:

<http://www.theorem.co.uk/docs/standard.htm> (from which several of the above descriptions were taken) and <http://www.ukceb.org/step/pages/stpgolb1.htm>

A report from the GM STEP Testing Center comparing STEP AP203 and IGES for Surface and Solid models can be found in the PDES, Inc. Public Archives @ [http://pdesinc.aticorp.org/whatsnew/archives/step\\_overview.html](http://pdesinc.aticorp.org/whatsnew/archives/step_overview.html)

### **Electrical/Electronics Product Data Exchange Standards:**

**EDIF**- ANSI/EIA (& IEC) Standard (Versions 2 0 0,(ANSI/EIA 548:1988) 3 0 0 (ANSI/EIA 548: 1993 & IEC 61695-1:1995) & 4 0 0 (IEC 61695-2:2000) have numerous ECAD Implementations (primarily EDIF 2 0 0)) - including schematic & netlist data

**IPC D35x** (IEC 61182-1:1994)- ANSI (& IEC)Standard for electrical/electronic connectivity

**Raster CCITT Group 4** --- An International Standard for raster data

**Gerber** (ANSI RS-274 X & D)- Widely used Industry "de facto" photo plot standard

**VHDL** (IEC 61691 Series)- ANSI/IEEE - Functional behavioral modeling language standard for electrical/electronic circuits

There are national and international standards; there are *de facto* and industry standards. They have varying levels of data coverage and acceptance. Typically, in the electrical/electronics domain, the Electronic Design Interchange Format (EDIF) has been used for the schematic and netlist; the format of the Institute for interconnecting and Packaging electronic Circuits (IPC) has been used for board layout and connectivity; the Initial Graphics Exchange Specification (IGES) has been used for the mechanical structure of the board, and the Gerber photoplot format has been used for photo layout. EDIF, IPC and IGES are American National Standards Institute (ANSI) standards; Gerber is a *de facto* industry "standard". Each of these provide "point" solutions for electrical/electronic product data exchange (i.e., schematic to schematic, layout to layout, mechanical to mechanical,...). They do not provide an integrated approach to the entire lifecycle of the products. For years, there have been attempts to harmonize the electrical/electronic product data exchange standards with only a modicum of success.

AP210 addresses the design of electronic assemblies, their interconnection and packaging. Within its scope are the "as-required", "as-designed" and "as-used" product information for the "in process" design and the "release" design. AP210 product data can be shared across several levels of the supply base and between design, analysis and manufacturing. AP210 provides a single data model which allows 3D component geometry, 2D bare board artwork, abstract behavioral models, and electrical network connections to be described and interrelated (i.e., all the information needed to manufacture a PCA).

## 4 Commercial Products and Services

### 4.1 CAD/CAM/CAE Vendor STEP Capabilities

The following table provides a summary of commercially available STEP translators for most of the major CAD/CAM/CAE vendors and comments on some of their near term future implementation plans. Each of these vendors has some level of STEP AP203 and "AP214" translator. This table was compiled from survey inputs from the vendors and CAx-Implementor Forum presentations. The table represents a "snap shot" of the status of commercially available STEP Translators at this point in time. **All of these vendors have other translators as well (e.g., Direct, IGES, DXF, etc.).**

**Table 11 — CAD Vendors with STEP Capabilities**

STEP Application Protocols (APs) 203 Edition 1, 203 Edition 2, and 214															
AP203 Edition 1: Configuration controlled design															
AP203 Edition 2: Configuration controlled 3D design of mechanical parts and assemblies															
AP214: Core data for automotive mechanical design processes															
Vendor	PDM			Geometry						Facets					
				Solids		Open Shells		Curve Bounded Surfaces					Wireframe		
<a href="#">Alias/StudioTools</a>	203	E1	Import	203	E1	Import	203	E1	Import	203	E1	Import	203	E1	Import
	203	E1	Export	203	E1	Export	203	E1	Export	203	E1	Export	203	E1	Export
	214		Import	214		Import	214		Import	214		Import	214		Import
	214		Export	214		Export	214		Export	214		Export	214		Export
	203		E2	203		E2	203		E2	203		E2	203		E2
	Import@Q405			Import@Q405			Import@Q405			Import@Q405			Import@Q405		
	203		E2	203		E2	203		E2	203		E2	203		E2
	Export@Q405			Export@Q405			Export@Q405			Export@Q405			Export@Q405		
<a href="#">Alias/ImageStudio</a>	203	E1	Import	203	E1	Import	203	E1	Import	203	E1	Import	203	E1	Import
	214		Import	214		Import	214		Import	214		Import	214		Import
	203		E2	203		E2	203		E2	203		E2	203		E2
	Import@Q405			Import@Q405			Import@Q405			Import@Q405			Import@Q405		
<a href="#">Alias/Maya</a>	203	E1	Import	203	E1	Import	203	E1	Import	203	E1	Import	203	E1	Import
	214		Import	214		Import	214		Import	214		Import	214		Import
	203		E2	203		E2	203		E2	203		E2	203		E2
	Import@Q405			Import@Q405			Import@Q405			Import@Q405			Import@Q405		
<a href="#">Autodesk/AutoCAD</a>	203	E1	Import	203	E1	Import	203	E1	Import	203	E1	Import			
	203	E1	Export	203	E1	Export	203	E1	Export	203	E1	Export			
	214		Import	214		Import	214		Import	214		Import			
	214 Export			214 Export			214 Export			214 Export					
<a href="#">Autodesk/Inventor</a>	203	E1	Import	203	E1	Import	203	E1	Import	203	E1	Import			
	203	E1	Export	203	E1	Export	203	E1	Export	203	E1	Export			
	214		Import	214		Import	214		Import	214		Import			
	214 Export			214 Export			214 Export			214 Export					
<a href="#">Autodesk/Mechanical Desktop</a>	203	E1	Import	203	E1	Import	203	E1	Import	203	E1	Import			
	203	E1	Export	203	E1	Export	203	E1	Export	203	E1	Export			
	214		Import	214		Import	214		Import	214		Import			
	214 Export			214 Export			214 Export			214 Export					

**STEP Application Protocols (APs) 203 Edition 1, 203 Edition 2, and 214**

AP203 Edition 1: Configuration controlled design

AP203 Edition 2: Configuration controlled 3D design of mechanical parts and assemblies

AP214: Core data for automotive mechanical design processes

Vendor	PDM	Geometry							
		Solids		Open Shells		Curve Bounded Surfaces		Wireframe	
<a href="#">Bentley/MicroStation</a>		203 E1 Import 203 E1 Export 214 Import 214 Export	203 E1 Import 203 E1 Export 214 Import 214 Export	203 E1 Import 203 E1 Export 214 Import 214 Export	203 E1 Import 203 E1 Export 214 Import 214 Export	203 E1 Import 203 E1 Export 214 Import 214 Export	203 E1 Import 203 E1 Export 214 Import 214 Export	203 E1 Import 203 E1 Export 214 Import 214 Export	203 E1 Import 203 E1 Export 214 Import 214 Export
<a href="#">CADKEY</a>	203 E1 Import 203 E1 Export 214 Import 214 Export	203 E1 Import 203 E1 Export 214 Import 214 Export	203 E1 Import 203 E1 Export 214 Import 214 Export	203 E1 Import 203 E1 Export 214 Import 214 Export	203 E1 Import 203 E1 Export 214 Import 214 Export	203 E1 Import 203 E1 Export 214 Import 214 Export			
<a href="#">CoCreate</a>	203 E1 Import 203 E1 Export 214 Import 214 Export	203 E1 Import 203 E1 Export 214 Import 214 Export	203 E1 Import 203 E1 Export 214 Import 214 Export	203 E1 Import 203 E1 Export 214 Import 214 Export	203 E1 Import 203 E1 Export 214 Import 214 Export	203 E1 Import 203 E1 Export 214 Import 214 Export			
<a href="#">Dassault/CATIA V4</a>		203 E1 Import 203 E1 Export 214 Import 214 Export	203 E1 Import 203 E1 Export 214 Import 214 Export	203 E1 Import 203 E1 Export 214 Import 214 Export	203 E1 Import 203 E1 Export 214 Import 214 Export	203 E1 Import 203 E1 Export 214 Import 214 Export	203 E1 Import 203 E1 Export 214 Import 214 Export	203 E1 Import 203 E1 Export 214 Import 214 Export	203 E1 Import 203 E1 Export 214 Import 214 Export
<a href="#">Dassault/CATIA V5</a>	214 Import 214 Export 203 E2 Import 203 E2 Export	203 E1 Import 203 E1 Export 214 Import 214 Export 203 E2 Import 203 E2 Export	203 E1 Import 203 E1 Export 214 Import 214 Export 203 E2 Import 203 E2 Export	203 E1 Import 203 E1 Export 214 Import 214 Export 203 E2 Import 203 E2 Export	203 E1 Import 203 E1 Export 214 Import 214 Export 203 E2 Import 203 E2 Export	203 E1 Import 203 E1 Export 214 Import 214 Export 203 E2 Import 203 E2 Export	203 E1 Import 203 E1 Export 214 Import 214 Export 203 E2 Import 203 E2 Export	203 E1 Import 203 E1 Export 214 Import 214 Export 203 E2 Import 203 E2 Export	
<a href="#">ITI TranscenData/CADfix</a>		203 E1 Import 203 E1 Export 214 Import 214 Export 203 E2 Import@Q405	203 E1 Import 203 E1 Export 214 Import 214 Export 203 E2 Import@Q405	203 E1 Import 203 E1 Export 214 Import 214 Export 203 E2 Import@Q405	203 E1 Import 203 E1 Export 214 Import 214 Export 203 E2 Import@Q405	203 E1 Import 203 E1 Export 214 Import 214 Export 203 E2 Import@Q405	203 E1 Import 203 E1 Export 214 Import 214 Export 203 E2 Import@Q405	203 E1 Import 203 E1 Export 214 Import 214 Export 203 E2 Import@Q405	
<a href="#">ITI TranscenData/CADIQ</a>		203 E1 Import 214 Import	203 E1 Import 214 Import	203 E1 Import 214 Import	203 E1 Import 214 Import	203 E1 Import 214 Import	203 E1 Import 214 Import	203 E1 Import 214 Import	

**STEP Application Protocols (APs) 203 Edition 1, 203 Edition 2, and 214**

AP203 Edition 1: Configuration controlled design

AP203 Edition 2: Configuration controlled 3D design of mechanical parts and assemblies

AP214: Core data for automotive mechanical design processes

Vendor	PDM	Geometry																	
		Solids			Open Shells			Curve Bounded Surfaces			Wireframe			Facets					
<a href="#">Kubotek/KeyCreator</a>		203	E1	Import	203	E1	Import	203	E1	Import	203	E1	Import	203	E1	Import			
		203	E1	Export	203	E1	Export	203	E1	Export	203	E1	Export	203	E1	Export			
		214		Import	214		Import	214		Import	214		Import	214		Import			
		214		Export	214		Export	214		Export	214		Export	214		Export			
		203	E2	Import	203	E2	Import	203	E2	Import	203	E2	Import	203	E2	Import			
<a href="#">Kubotek/REALyze</a>		203	E1	Import	203	E1	Import	203	E1	Import	203	E1	Import	203	E1	Import			
		203	E1	Export	203	E1	Export	203	E1	Export	203	E1	Export	203	E1	Export			
		214		Import	214		Import	214		Import	214		Import	214		Import			
		214		Export	214		Export	214		Export	214		Export	214		Export			
		203	E2	Import	203	E2	Import	203	E2	Import	203	E2	Import	203	E2	Import			
<a href="#">Kubotek/Spectrum</a>		203	E1	Import	203	E1	Import	203	E1	Import	203	E1	Import	203	E1	Import			
		203	E1	Export	203	E1	Export	203	E1	Export	203	E1	Export	203	E1	Export			
		214		Import	214		Import	214		Import	214		Import	214		Import			
		214		Export	214		Export	214		Export	214		Export	214		Export			
		203	E2	Import	203	E2	Import	203	E2	Import	203	E2	Import	203	E2	Import			
<a href="#">Navy LEAPS</a>	203 E1 Import 203 E1 Export (planned)	203	E1	Import	203	E1	Import		203	E1	Import	203	E1	Import					
		203	E1	Export	203	E1	Export		203	E1	Export	203	E1	Export					
<a href="#">LKSoft/IDA-STEP Center</a>	203 E1 Import 203 E1 Export 214 Import 214 Export 203 E2 Import 203 E2 Export	203	E1	Import	203	E1	Import	203	E1	Import	203	E1	Import	203	E1	Import	203	E1	Import
		203	E1	Export	203	E1	Export	203	E1	Export	203	E1	Export	203	E1	Export	203	E1	Export
		214		Import	214		Import	214		Import	214		Import	214		Import	214		Import
		214		Export	214		Export	214		Export	214		Export	214		Export	214		Export
		203	E2	Import	203	E2	Import	203	E2	Import	203	E2	Import	203	E2	Import	203	E2	Import
		203	E2	Export	203	E2	Export	203	E2	Export	203	E2	Export	203	E2	Export	203	E2	Export
<a href="#">LKSoft/IDA-STEP Viewer</a>	203 E1 Import 214 Import 203 E2 Import	203	E1	Import	203	E1	Import	203	E1	Import	203	E1	Import	203	E1	Import	203	E1	Import
		214		Import	214		Import	214		Import	214		Import	214		Import	214		Import
		203	E2	Import	203	E2	Import	203	E2	Import	203	E2	Import	203	E2	Import	203	E2	Import
<a href="#">McNeal Schwendler: Patran</a>	203 E1 Import 203 E1 Export 214 Import 214 Export	203	E1	Import	203	E1	Import	203	E1	Import	203	E1	Import	203	E1	Import	203	E1	Import
		203	E1	Export	203	E1	Export	203	E1	Export	203	E1	Export	203	E1	Export	203	E1	Export
		214		Import	214		Import	214		Import	214		Import	214		Import	214		Import
		214		Export	214		Export	214		Export	214		Export	214		Export	214		Export

**STEP Application Protocols (APs) 203 Edition 1, 203 Edition 2, and 214**

AP203 Edition 1: Configuration controlled design

AP203 Edition 2: Configuration controlled 3D design of mechanical parts and assemblies

AP214: Core data for automotive mechanical design processes

Vendor	PDM	Geometry							
		Solids		Open Shells		Curve Bounded Surfaces		Wireframe	
<a href="#">Open Cascade/Open Cascade 5.2</a>		203 E1 Import 203 E1 Export 214 Import 214 Export 203 E2 Import@Q206 203 E2 Export@Q206	203 E1 Import 203 E1 Export 214 Import 214 Export 203 E2 Import@Q206 203 E2 Export@Q206	203 E1 Import 203 E1 Export 214 Import 214 Export 203 E2 Import@Q206 203 E2 Export@Q206	203 E1 Import 203 E1 Export 214 Import 214 Export 203 E2 Import@Q206 203 E2 Export@Q206	203 E1 Import 203 E1 Export 214 Import 214 Export 203 E2 Import@Q206 203 E2 Export@Q206	203 E1 Import 203 E1 Export 214 Import 214 Export 203 E2 Import@Q206 203 E2 Export@Q206	203 E1 Import 203 E1 Export 214 Import 214 Export 203 E2 Import@Q206 203 E2 Export@Q206	203 E1 Import 203 E1 Export 214 Import 214 Export 203 E2 Import@Q206 203 E2 Export@Q206
<a href="#">Theorem/CADverter CADDS</a>	203E1 Import 203E1 Export 203E2 Import 203E2 Export 214 Import 214 Export	203E1 Import 203E1 Export 203E2 Import 203E2 Export 214 Import 214 Export	203E1 Import 203E1 Export 203E2 Import 203E2 Export 214 Import 214 Export	203E1 Import 203E1 Export 203E2 Import 203E2 Export 214 Import 214 Export	203E1 Import 203E1 Export 203E2 Import 203E2 Export 214 Import 214 Export	203E1 Import 203E1 Export 203E2 Import 203E2 Export 214 Import 214 Export	203E1 Import 203E1 Export 203E2 Import 203E2 Export 214 Import 214 Export	203E1 Import 203E1 Export 203E2 Import 203E2 Export 214 Import 214 Export	203E1 Import 203E1 Export 214 Import
<a href="#">Theorem/CADverter CATIA4</a>	203E1 Import 203E1 Export 203E2 Import 203E2 Export 214 Import 214 Export 209 Import 209 Export	203E1 Import 203E1 Export 203E2 Import 203E2 Export 214 Import 214 Export 209 Import 209 Export	203E1 Import 203E1 Export 203E2 Import 203E2 Export 214 Import 214 Export 209 Import 209 Export	203E1 Import 203E1 Export 203E2 Import 203E2 Export 214 Import 214 Export 209 Import 209 Export	203E1 Import 203E1 Export 203E2 Import 203E2 Export 214 Import 214 Export 209 Import 209 Export	203E1 Import 203E1 Export 203E2 Import 203E2 Export 214 Import 214 Export 209 Import 209 Export	203E1 Import 203E1 Export 203E2 Import 203E2 Export 214 Import 214 Export 209 Import 209 Export	203E1 Import 203E1 Export 203E2 Import 203E2 Export 214 Import 214 Export 209 Import 209 Export	203E1 Import 203E1 Export 203E2 Import 203E2 Export 214 Import 214 Export 209 Import 209 Export
<a href="#">Theorem/CADverter JT</a>	203E1 Import 203E2 Import	203E1 Import 203E2 Import	203E1 Import 203E2 Import	203E1 Import 203E2 Import	203E1 Import 203E2 Import	203E1 Import 203E2 Import	203E1 Import 203E2 Import	203E1 Import 203E2 Import	203E1 Import 203E2 Import
<a href="#">Theorem/CADverter I-DEAS</a>	203E1 Import 203E1 Export 203E2 Import 203E2 Export 214 Import 214 Export	203E1 Import 203E1 Export 203E2 Import 203E2 Export 214 Import 214 Export	203E1 Import 203E1 Export 203E2 Import 203E2 Export 214 Import 214 Export	203E1 Import 203E1 Export 203E2 Import 203E2 Export 214 Import 214 Export	203E1 Import 203E1 Export 203E2 Import 203E2 Export 214 Import 214 Export	203E1 Import 203E1 Export 203E2 Import 203E2 Export 214 Import 214 Export	203E1 Import 203E1 Export 203E2 Import 203E2 Export 214 Import 214 Export	203E1 Import 203E1 Export 203E2 Import 203E2 Export 214 Import 214 Export	203E1 Import 203E1 Export 214 Import

**STEP Application Protocols (APs) 203 Edition 1, 203 Edition 2, and 214**

AP203 Edition 1: Configuration controlled design

AP203 Edition 2: Configuration controlled 3D design of mechanical parts and assemblies

AP214: Core data for automotive mechanical design processes

Vendor	PDM	Geometry									
		Solids		Open Shells		Curve Bounded Surfaces		Wireframe		Facets	
<a href="#">Theorem/CADverter Parasolid</a>	203E1 Import 203E1 Export 203E2 Import 203E2 Export 214 Import 214 Export	203E1 Import 203E1 Export 203E2 Import 203E2 Export 214 Import 214 Export	203E1 Import 203E1 Export 203E2 Import 203E2 Export 214 Import 214 Export	203E1 Import 203E1 Export 203E2 Import 203E2 Export 214 Import 214 Export	203E1 Import 203E1 Export 203E2 Import 203E2 Export 214 Import 214 Export	203E1 Import 203E1 Export 203E2 Import 203E2 Export 214 Import 214 Export	203E1 Import 203E1 Export 203E2 Import 203E2 Export 214 Import 214 Export	203E1 Import 203E1 Export 203E2 Import 203E2 Export 214 Import 214 Export	203E1 Import 203E1 Export 203E2 Import 203E2 Export 214 Import 214 Export	203E1 Import 203E1 Export 203E2 Import 203E2 Export 214 Import 214 Export	203E1 Import 203E1 Export 203E2 Import 203E2 Export 214 Import 214 Export
<a href="#">Theorem/CADverter SC03</a>	203E1 Import 203E1 Export 203E2 Import 203E2 Export 214 Import 214 Export	203E1 Import 203E1 Export 203E2 Import 203E2 Export 214 Import 214 Export	203E1 Import 203E1 Export 203E2 Import 203E2 Export 214 Import 214 Export	203E1 Import 203E1 Export 203E2 Import 203E2 Export 214 Import 214 Export	203E1 Import 203E1 Export 203E2 Import 203E2 Export 214 Import 214 Export	203E1 Import 203E1 Export 203E2 Import 203E2 Export 214 Import 214 Export	203E1 Import 203E1 Export 203E2 Import 203E2 Export 214 Import 214 Export	203E1 Import 203E1 Export 203E2 Import 203E2 Export 214 Import 214 Export	203E1 Import 203E1 Export 203E2 Import 203E2 Export 214 Import 214 Export	203E1 Import 203E1 Export 203E2 Import 203E2 Export 214 Import 214 Export	203E1 Import 203E1 Export 203E2 Import 203E2 Export 214 Import 214 Export
<a href="#">Theorem/CADverter Unigraphics NX</a>	203E1 Import 203E1 Export 203E2 Import 203E2 Export 214 Import 214 Export	203E1 Import 203E1 Export 203E2 Import 203E2 Export 214 Import 214 Export	203E1 Import 203E1 Export 203E2 Import 203E2 Export 214 Import 214 Export	203E1 Import 203E1 Export 203E2 Import 203E2 Export 214 Import 214 Export	203E1 Import 203E1 Export 203E2 Import 203E2 Export 214 Import 214 Export	203E1 Import 203E1 Export 203E2 Import 203E2 Export 214 Import 214 Export	203E1 Import 203E1 Export 203E2 Import 203E2 Export 214 Import 214 Export	203E1 Import 203E1 Export 203E2 Import 203E2 Export 214 Import 214 Export	203E1 Import 203E1 Export 203E2 Import 203E2 Export 214 Import 214 Export	203E1 Import 203E1 Export 203E2 Import 203E2 Export 214 Import 214 Export	203E1 Import 203E1 Export 203E2 Import 203E2 Export 214 Import 214 Export
<a href="#">Theorem/ExtReSTEP</a>											
<a href="#">Theorem/PDMAXS</a>	203E1 Import 203E1 Export 203E2 Import 203E2 Export 214 Import 214 Export 209 Import 209 Export										
<a href="#">Theorem/CADviewer</a>		203E1 Import 203E1 Export 203E2 Import 203E2 Export 214 Import 214 Export	203E1 Import 203E1 Export 203E2 Import 203E2 Export 214 Import 214 Export	203E1 Import 203E1 Export 203E2 Import 203E2 Export 214 Import 214 Export	203E1 Import 203E1 Export 203E2 Import 203E2 Export 214 Import 214 Export	203E1 Import 203E1 Export 203E2 Import 203E2 Export 214 Import 214 Export	203E1 Import 203E1 Export 203E2 Import 203E2 Export 214 Import 214 Export	203E1 Import 203E1 Export 203E2 Import 203E2 Export 214 Import 214 Export	203E1 Import 203E1 Export 203E2 Import 203E2 Export 214 Import 214 Export	203E1 Import 203E1 Export 203E2 Import 203E2 Export 214 Import 214 Export	203E1 Import 203E1 Export 203E2 Import 203E2 Export 214 Import 214 Export



**STEP Application Protocols (APs) 203 Edition 1, 203 Edition 2, and 214**

AP203 Edition 1: Configuration controlled design

AP203 Edition 2: Configuration controlled 3D design of mechanical parts and assemblies

AP214: Core data for automotive mechanical design processes

Vendor	PDM	Geometry												
		Solids			Open Shells			Curve Bounded Surfaces			Wireframe			Facets
<a href="#">Theorem/DXN</a>	203E1 Import 203E1 Export 203E2 Import 203E2 Export 214 Import 214 Export	203E1 Import 203E1 Export 203E2 Import 203E2 Export 214 Import 214 Export	203E1 Import 203E1 Export 203E2 Import 203E2 Export 214 Import 214 Export	203E1 Import 203E1 Export 203E2 Import 203E2 Export 214 Import 214 Export	203E1 Import 203E1 Export 203E2 Import 203E2 Export 214 Import 214 Export	203E1 Import 203E1 Export 203E2 Import 203E2 Export 214 Import 214 Export	203E1 Import 203E1 Export 203E2 Import 203E2 Export 214 Import 214 Export	203E1 Import 203E1 Export 203E2 Import 203E2 Export 214 Import 214 Export	203E1 Import 203E1 Export 203E2 Import 203E2 Export 214 Import 214 Export	203E1 Import 203E1 Export 203E2 Import 203E2 Export 214 Import 214 Export				
<a href="#">T-Systems/CATIA</a>	203 E1 Import 203 E2 Import 214 Import 214 Export	203 E1 Import 203 E2 Import 214 Import 214 Export	203 E1 Import 203 E2 Import 214 Import 214 Export	203 E1 Import 203 E2 Import 214 Import 214 Export	203 E1 Import 203 E2 Import 214 Import 214 Export	203 E1 Import 203 E2 Import 214 Import 214 Export	203 E1 Import 203 E2 Import 214 Import 214 Export	203 E1 Import 203 E2 Import 214 Import 214 Export	203 E1 Import 203 E2 Import 214 Import 214 Export	203 E1 Import 203 E2 Import 214 Import 214 Export				
<a href="#">UGS PLM Solutions/i-deas 12 NX</a>	203 E1 Import 203 E1 Export	203 E1 Import 203 E1 Export 214 Import 214 Export 203 E2 Import@Q405 203 E2 Export@Q405	203 E1 Import 203 E1 Export 214 Import 214 Export 203 E2 Import@Q405 203 E2 Export@Q405	203 E1 Import 203 E1 Export 214 Import 214 Export 203 E2 Import@Q405 203 E2 Export@Q405	203 E1 Import 203 E1 Export 214 Import 214 Export 203 E2 Import@Q405 203 E2 Export@Q405	203 E1 Import 203 E1 Export 214 Import 214 Export 203 E2 Import@Q405 203 E2 Export@Q405	203 E1 Import 203 E1 Export 214 Import 214 Export 203 E2 Import@Q405 203 E2 Export@Q405	203 E1 Import 203 E1 Export 214 Import 214 Export 203 E2 Import@Q405 203 E2 Export@Q405	203 E1 Import 203 E1 Export 214 Import 214 Export 203 E2 Import@Q405 203 E2 Export@Q405	203 E1 Import 203 E1 Export 214 Import 214 Export 203 E2 Import@Q405 203 E2 Export@Q405				
<a href="#">UGS PLM Solutions/NX</a>	203 E1 Import 203 E1 Export 214 Import 214 Export	203 E1 Import 203 E1 Export 214 Import 214 Export	203 E1 Import 203 E1 Export 214 Import 214 Export	203 E1 Import 203 E1 Export 214 Import 214 Export	203 E1 Import 203 E1 Export 214 Import 214 Export	203 E1 Import 203 E1 Export 214 Import 214 Export	203 E1 Import 203 E1 Export 214 Import 214 Export	203 E1 Import 203 E1 Export 214 Import 214 Export	203 E1 Import 203 E1 Export 214 Import 214 Export	203 E1 Import 214 Import				

**Table 12 — Vendors with other STEP Capabilities**

Vendor	AP support	Capabilities
<a href="#">Dassault/CATIA V4</a>	AP227	Import and export translator
<a href="#">LSC Group</a> <a href="#">LOCAM</a>	AP224, AP240	PC based system that is able to automatically analyse, estimate and plan the manufacture of mechanical spares using data defined according to the ISO 10303 (STEP) AP224
<a href="#">LKSoftWare</a>	AP210, AP203, AP212, AP214, STEP API	<p><b>IDA-STEP Electronics</b> is a major branch in the IDA-STEP product line dealing with all aspects of industrial data around Printed Circuit Boards (PCB) and Printed Circuit Assemblies (PCA). IDA-STEP Electronics provides PCB and PCA viewing capabilities, displaying design and usage views in 2D and 3D, conveniently listing components, networks, layers, connectivity, etc. Import and export to many different formats makes IDA-STEP Electronics a perfect bridge or integration platform for different tools. Moreover, using IDA-STEP Electronics, AP210 data can be integrated with electrical and mechanical (ECAD/MCAD) data.</p> <p><b>JSDAI™</b> is an Application Programming Interface (API) for reading, writing and runtime manipulation of object oriented data defined by an EXPRESS based data model. Features:</p> <ul style="list-style-type: none"> <li>• Full conformance to the STEP standard (ISO 10303-11, 21, 22, 27, 28, 35)</li> <li>• Supports 4 different API levels to optionally support different kinds of implementations</li> <li>• Com piling of EXPRESS schemas</li> <li>• Include s a library of practically all EXPRESS schemas from STEP and PLIB standards</li> <li>• 3D Viewing module for displaying STEP geometry</li> <li>• STEP-Book framework for developing graphical end-user applications</li> <li>• Fully Java™ based, thus platform independent</li> <li>• Import and export of persistent data using STEP-File or STEP-XML</li> <li>• and more (visit <a href="http://www.jsdai.net">www.jsdai.net</a> for more information)</li> </ul> <p><b>IDA-STEP</b> is a family of software products for PDM (Product data management) and CAD data, which are fully based on the international and vendor neutral STEP standard (ISO 10303). This ensures that every detail of the data you handle in IDA-STEP can be exported at any time into STEP-Files. You can use these files to transfer your data into another PDM system or for archiving purpose. STEP-Files are ideally suited for long-term archiving as required e.g. for the air-space industry. IDA-STEP addresses data according to the STEP Application Protocols:</p> <ul style="list-style-type: none"> <li>- AP203: <i>Configuration controlled design</i></li> <li>- AP212: <i>Electrotechnical design and installation</i></li> <li>- AP214: <i>Core data for automotive mechanical design processes</i></li> <li>- PDM Schema, a unified sub-set of several STEP APs</li> </ul>
<a href="#">McNeal Schwendler:</a> <a href="#">Patran</a>	AP203, AP209	Patran is the leading pre- and post processor for CAE simulation. The programs advanced modeling and surfacing tools allow you to create a finite element model from scratch. You can also take advantage of Patran's advanced CAD access tools to work directly on your existing CAD model. With direct access, Patran imports model geometry without modifications. No translation takes place, so your CAD geometry remains intact. After geometry is imported, you can use Patran to define loads, boundary

		conditions, and material properties.
<a href="#">STEP Tools, Inc.:</a> ST- ACIS v6.0  ST- Parasolid v11.0  ST-Viewer v3.1	AP 201, 202, 203, 209, 214e2, 215, 216, 218, 224e2, 225, 227, 232, 238	<b>ST-Developer Project License</b> All tools and libraries for one platform (Windows, Linux, MacOS, Solaris, etc) with as many seats as your team needs. (additional platforms optional) Unlimited license to sell products built using the ST-Developer Programming libraries. <b>Software Development Libraries</b> Base C, C++, and Java libraries to read, write, create, search, and manipulate any STEP data. Custom class libraries for AP 201, 202, 203, 209, 214e2, 215, 216, 218, 224e2, 225, 227, 232, 238, CIMsteel CIS/2, and IFC. <a href="#">ST-ACIS kernel interface library</a> (optional) <a href="#">ST-Parasolid kernel interface library</a> (optional) <b>Data Viewing and Verification Tools</b> <a href="#">ST-Viewer</a> Geometry and Product display, with OLE/COM programmable interface (Windows) STEP Part 21 File Browser STEP File Cleaner AP-203 Custom Data Checker AP-209 Custom Data Checker AP-214 Custom Data Checker General EXPRESS-based Data Checker Sample data sets for many STEP APs IGES and DXF Data access tools <b>EXPRESS Schema Tools</b> EXPRESS Compiler with checking, data dictionary and short to longform EXPRESS Generators to C++, Java, and HTML, along with class customization tools
<a href="#">Surfware, Inc.:</a> <a href="#">SurfCAM</a>	No STEP Translator, Has ACIS translator, Could use an ACIS/STEP translator to import STEP AP203/AP214 files	SURFCAM™ CAD/CAM systems allow you to machine with experience and provide cutting edge technology for NC programming of 2-, 3-, 4- and 5-axis mills, lathes, wire EDM, laser plasma and water-jet machines.
<a href="#">SCRA:</a> <a href="#">STEPTrans (Pro/E)</a> <a href="#">STEPValidator (ICAD)</a> <a href="#">STEPPlan (ICAD)</a>	AP224, AP240	STEPTrans performs the conversion of various forms of existing technical data into a digital format that is fully compliant with AP224 of STEP. STEPTrans also provides an AP203-formatted file and an IGES file as outputs.  The STEP Validator is a stand-alone PC application that highlights STEP features in a 3-D viewer. The application includes a validation/discrepancy feature that documents errors.  STEPPlan uses feature-based CAPP technology to quickly generate process plans within a unique data fusion environment.

<a href="#">Industrial Planning Technology</a>	AP227	<p>Industrial Planning Technology Inc has developed several tools which import AP 227:</p> <p>(1) SmartPlanPiping[tm] - a fabrication and installation planning tool for shipyards</p> <p>(2) SmartPipeShop[tm] - a pipe shop management tool</p> <p>(3) SmartRoutePiping[tm] - a semi-automatic 3D router for piping (import and export AP 227)</p> <p>Industrial Planning Technology is also developing an AP 227 import/export translator for the ShipConstructor CAD package.</p>
--	-------	---

Commercially available "STEP" translators are almost exclusively AP203 and the essentially "equivalent" AP214 cc1 & cc2 translators. In other words, geometry (wireframe, surfaces, and advanced B-Rep solids) and a subset of configuration management data are what have been implemented. There are some other commercially available STEP translators (AP202 - Pro/E, AP207 - CATIA, AP209 - MSC, AP210 - Mentorgraphics BoardStation (by ITI), and AP224 - SCRA). The SCRA Program has a process planning system (STEPPlan) which reads in AP224 and AP203 files, and several CAE vendors have indicated their intention to implement AP210. (An AP210 Implementation for Eagle (LKSoft) exists, and plans are underway for development of an AP210 translator for Zuken-Redac's Freedom System (a 3-D ECAD System). Others are still in the "planning" or negotiation stage with the vendors. The vendors need external funding or a business case from major users to implement STEP AP's.

There are numerous prototype implementations of other STEP AP's such as:

- SCRA's Prototype AP210 Data Conversion and Verification Environment (DCVE) and AP220-based Generative Assembly Process Planner (GAPP) also exist. (See 2.9.4 and Document 11 in Appendix A.)
- ISE Prototype AP216 and AP218 implementations for selected conformance classes for several Shipbuilding Structural Design Systems (namely):
  - a) ISDP/Intelliship (Intergraph)
  - b) CATIA (Dassault Systems) (translators by STEP Tools, Inc.)
  - c) FORAN (Sener, Ingenieria Sistemas, S.A.)
  - d) TRIBON (Aveva) (translators by Atlantec Enterprise Solutions)
  - e) LEAPS (translators by Product Data Services)
  - f) Safe Hull (ABS)
- ISE Prototype AP215 implementations for selected conformance classes for several Shipbuilding Structural Design Systems (namely):
  - a) ISDP/Intelliship (Intergraph)
  - b) FORAN (Sener, Ingenieria Sistemas, S.A.)
  - c) TRIBON (Aveva) (translators by Atlantec Enterprise Solutions)
  - d) LEAPS (translators by Product Data Services)
- ISE Prototype AP227 (Edition 2) implementations for conformance classes 1,2,4,7, & 9 for Shipbuilding Piping and HVAC applications including:
  - a) ISDP/Intelliship (Intergraph)
  - b) CATIA (Dassault Systems) (translators by Atlantec Enterprise Solutions)
  - c) FORAN (Sener, Ingenieria Sistemas, S.A.)
  - d) TRIBON (Aveva) (translators by Atlantec Enterprise Solutions)
  - e) Simsmart (XML Part 28 implementation)
  - f) Electric Boat (input from CATIA to PIPESTRESS 2000)
- ISE Prototype AP209 implementations feeding various Engineering Analysis Programs through Electric Boat's COMMANDS System

- ISE Prototype AP212 implementations through Knowledge Manager (KSSI)

Several major aerospace companies are doing their own implementations as prototypes, proofs of concept and even production implementations in anticipation of requiring the capability or providing and/or receiving STEP formatted data from members of their supply chains. This is especially true in the PDM and Technical Data Packaging areas (viz., the PDM Schema and AP232) where Boeing will be requiring the exchange of data with their suppliers in AP232 cc 4 & 6 format and Lockheed Martin requiring compliance with AP232 cc 1, 2 & 3. BAE Systems has already implemented the PDM Schema in Production, and Northrop Grumman has developed a prototype AP232/Metaphase interface for selected conformance classes of AP232.

## 4.2 Direct Translators, Services, and Tools

### 4.2.1 Direct Translators

It should be noted that a number of vendors and 3<sup>rd</sup> Party software development companies have developed direct translators for those CAD systems used frequently to exchange data. Below are some examples with references to related web sites. (This list has grown since the first publication of this Handbook.)

- **Cimsoftek** – supports many data formats used in MCAD – <http://www.cimsoftek.com>
- **Compunix** - Numerous combinations involving CATIA, UG, and Pro/E - <http://www.compunix-usa.com/products/products.htm>
- **Geometric Software Solutions, Co Ltd** - (Collaboration with Spatial/Dassault) – Feature Recognition and Data Exchange for CAD/CAM/CAE/PDM Systems – <http://www.geometricsoftware.com>
- **PTC** - direct geometry translators for CATIA®, PDGS, CADAM®, - <http://www.ptc.com/products/proe/foundation/interfaces.htm>
- **Theorem Solutions** - Combinations of CADD5, CATIA, SolidEdge, SolidWorks, Unigraphics, Mechanical Desktop, Pro/Engineer, etc. <http://www.theorem.co.uk/docs/prodov.htm>
- **(To review: Select the CAD system listed in CADverter)**
- **UGSolutions** - CATIA/UG. PDGS/UG, CADD4X/5->UG [http://support.ugs.com/services/data\\_exchange.html](http://support.ugs.com/services/data_exchange.html)
- **Spatial** (a Dassault Systèmes S.A company) – CATIA v4, Pro/E, Parasolid, ACIS - [http://www.spatial.com/products/interop/Components/interop\\_spec/?LV3=Y](http://www.spatial.com/products/interop/Components/interop_spec/?LV3=Y)
- **Translation Technologies, Inc.** – On-line service for conversion and exchange of CAD data, including web-based solutions – <http://www.translationtech.com>

### 4.2.2 Translation Services:

To meet the needs for product data exchange (usually for small and medium sized enterprises (SME's)), translation services have been established by some of the major players in the STEP community. More information on these translation services can be obtained by visiting the indicated web sites. (This list also has grown since the first publication of this Handbook. Many of these companies offer on-line and web-based on demand services.)

- **Cimsoftek** – supports many data formats used in MCAD (Pay per use or purchase)– <http://www.cimsoftek.com>

- **Geometric Software Solutions, Co Ltd** - (Collaboration with Spatial/Dassault) – Feature Recognition and Data Exchange for CAD/CAM/CAE/PDM Systems – <http://www.geometricsoftware.com>
- **ITI Data Exchange (DEX) Center**
- (<http://www.iti-oh.com/pdi/dexcenter/index.htm>)
- **STEP Tools, Inc. Translation Service** (<http://www.steptools.com/strepo/translate.cgi>)
- **Theorem Solutions** - Data Exchange Translation Services using both direct and STEP -based (AP203 or AP214) translators (<http://www.theorem.co.uk/docs/bureau.htm>)
- **UGSolutions** - Data Exchange Translation Services using both direct and standards-based (STEP AP203/214, flavored IGES, and DXF) translators ([http://support.ugs.com/services/data\\_exchange.html](http://support.ugs.com/services/data_exchange.html) )
- **PlanetCAD** (formerly a division of Spatial Technology Inc.) - Data Exchange Translation Services using Theorem Solutions' CADverter <http://www.planetcad.com/PROD/entsolcadvert.html>
- **PDES, Inc. Prove-Out System (for Members only)** - "Tests"/Proves-out commercially available STEP (AP203 and AP214) translators for models in numerous CAD Systems. (Currently, there are 7 CAD Systems in the PDES, Inc. Prove-Out Lab.)
- **Translation Technologies, Inc.** – On-line service for conversion and exchange of CAD data, including web-based solutions – <http://www.translationtech.com>

### 4.2.3 Solid Modelers

(See Vendor Web Sites for more detail on Products.)

- **Spatial Technology, Inc.** - ACIS - used as the solids modeling kernel in numerous CAD/CAM systems including AutoCAD, Mechanical Desktop, Design Studio, and others.
  - <http://www.spatial.com/>
- **UGSolutions** - Parasolid - used as the solids modeling kernel in numerous CAD/CAM systems including Unigraphics, Solid Edge, SolidWorks, and others.
  - <http://www.ugs.com/index.shtml>
- **Dassault** - CATIA uses own proprietary solids modeling kernel.
  - <http://www.3ds.com/home>
- **PTC** - Pro/ENGINEER uses own proprietary solids modeling kernel.
  - <http://www.ptc.com/>
- **UGS** - I-DEAS uses own proprietary solids modeling kernel.
  - <http://www.ugs.com/products/nx/ideas/>

Comment: In theory, if a user is using a CAD System with an ACIS or a Parasolid kernel, that user can generate or read .sat (ACIS) or .xmt, x\_t, or eXT (Parasolid) files. The user can then use an ACIS/STEP or a Parasolid/STEP translator, as appropriate, to generate or read a STEP AP203 (or AP214) file. This, theoretically, addresses STEP AP203/AP214 Advanced B-Rep translation for ACIS and Parasolid based systems.

### 4.2.4 STEP Tool Vendors

In the development of both the STEP Standard and STEP translators, some companies have developed tools to facilitate the development. Most notably in the STEP community are the following:

- **EPM** - EXPRESS Data Manager Suite of tools for application development and integration (Contains EDMmodelConverter which "uses EXPRESS-X to convert data from one EXPRESS schema to another") (<http://www.epmtech.jotne.com/products/index.html>)
- **ITI** - (**PDE/Lib, IGES/Works, CAD/IQ, CADfix**) (Changed name from ITI PDI to TranscenData (Global Interoperability Solutions)) <http://www.transcendata.com>
- **"NIST"**
  - a) **EXPRESS Engine** (Formerly **EXPRESSO** (EXPRESS Language Environment) ("Freeware")) (<http://exp-engine.sourceforge.net/>)
- **PD Tec** - ECCO Toolkit (EXPRESS Compiler) ("provides the building blocks ... and a software development environment to ... implement product data technology" - (<http://www.pdtec.de/>))
- **STEP Tools, Inc.** - ST-Developer (to build and maintain STEP Applications) - (<http://www.steptools.com/products/>)
- **ISE Project** – Website has been developed by the NSRP Integrated Shipbuilding Environment (ISE) Project to provide publicly available free of charge mediation and translation software – ([www.isetools.org](http://www.isetools.org))
  - **JEN-X** – Convert document from EXPRESS to XML (available as Open Source on [Sourceforge.net](http://Sourceforge.net))
  - **P21 to P28 Converter** – Convert files between STEP and XML representations
  - **Mediators** – Tools to translate data between various STEP formats

Also to be noted in the category of "tools" to help users are the "trouble shooting" tools such as CAD/IQ from TranscenData, and the geometry "healers" built into translators from Theorem Solutions, CATIA, Unigraphics, Pro/ENGINEER, and others.

## 5 Pilots & Prototypes

At this point in time, robust commercial STEP translators include AP203 (cc's 1, 2, 4, and 6) and AP214 (cc's 1 & 2). These translators have been proved-out through rather extensive testing in forums such as PDES, Inc's STEPnet, ProSTEP's rally, and now the joint PDES, Inc./ProSTEP CAX-Implementors Forum. The early problems with accuracy and interoperability have essentially been eliminated, and the translators are of good quality.

Commercial implementation of other STEP AP's, with only a few exceptions as noted above, is rather slow in coming. But, this is not to say that other STEP AP's are not being tested. In fact there are, and have been, numerous pilots, prototypes and prove-outs throughout the world that are showing that STEP AP's in a wide variety of application domains can and do meet the requirements specified in the scopes of these application protocols.

These activities and the successes that they are demonstrating show that there is significant support throughout the world, especially in the CAD/CAM user community, for STEP to succeed. Most of the countries participating in TC184/SC4 have established STEP Centers. There are many STEP related R & D projects funded by national governments throughout the world. The CAD/CAM/CAE vendors participate in these prototyping projects to the extent to which they are funded. There is still limited vendor commitment to producing commercial STEP translation products at this point in time.

To illustrate the extent of the STEP related piloting activities, some of these many activities will be cited below with references given to web sites for additional information.

The SCRA's Advanced Technology Institute (ATI) houses PDES, Inc. which is an industrial consortium chartered with accelerating the development and implementation of STEP. More than twenty major automotive, aerospace and CAD/CAM vendor and user companies actively participate in their numerous STEP projects. (visit [http://pdesinc.aticorp.org/step\\_overview.html](http://pdesinc.aticorp.org/step_overview.html))

#### **PDES, Inc. Pilots:**

- STIR - STEP TDP Interoperability Readiness Pilot (AP232 & AP203 cc1)
- STEPwise - STEP web integrated supplier exchange (AP232/PDM)
  - a) An extension of the STIR Pilot
  - b) Estimated Annual Pre-Production Savings per supplier - \$64K
- Eurofighter PDM Pilot (Unified PDM Schema)
- ISAP - International STEP Automotive Project
  - a) Joint with ProSTEP
  - b) AP Interoperability (AP202, AP203, AP214)
  - c) PDM
- Electromechanical Pilot - AP210/AP203
- AEA - Aerospace Engine Alliance - AP203/PDM Schema
- Engineering Analysis - AP209
- TURBINE - AP203
  - a) Cross Section & Assembly Solid Models
- AWS - Advanced Weapon System (AP203/AP202)
- CSTAR - (AP203 cc1) (See Production Implementation @ McDonnell Douglas)
- AeroSTEP - (AP203 cc5 & cc6) for Digital Pre-Assembly Solid (See Production Implementation @ Boeing)
- STAMP – Supply-chain Technologies for Affordable Missile Products – AP232/STEP PDM Schema
- VAST – Validating Advanced Supply Chain Technology
- LTDR (Using STEP for Long Term Data Retention)

#### **ATI - NIST**

- PreAMP- Precompetitive Advanced Manufacturing Program - AP210CD/AP220WD

#### **ATI - DARPA**

- TIGER - Team InteGrated - Electronic Response - An extension of PreAMP (AP210 DIS & AP220 WD)
- STAMP - Supply-chain Technologies for Affordable Missile Products - AP232/STEP PDM Schema

#### **DARPA**

- **MARITECH STEP Program** - Accelerate STEP development and assess implementability in U.S. Marine Industry

#### **AIAG**

- AutoSTEP - AP203 cc6
  - b) Publications (<http://www.aiag.org/>)
  - c) STEP/IGES Comparison
  - d) Direct Translator Comparison



#### **ATI - USAF/WPAFB-WL**

- PAS-C - PDES Application protocol Suite for Composites - AP203/AP209/AP232/AP222

#### **ATI - TACOM**

- **TACOM Pilot** - an extension of PAS-C with the Army - AP203/AP209/AP232/AP222

#### **NIST**

- Plant STEP Consortium - AP225
- STEP AP213 Coverage Analysis Pilot
- ATP – Supermodel/STEP-NC Project (AP238 & ISO 14649)
- IMS – Integrated Manufacturing Systems (A series of Projects related to Manufacturing)  
<http://www.ims.org>

#### **NSRP – ISEC**

- ESTEP – AP216 & AP218 Prototype Demonstrations
- Harvest – AP’s 215, 216, 218 (to IS)

#### **SCRA/RAMP - DLA**

- STEP Feature-based Manufacturing Pilots
- Reports with Cost/Time Savings Metrics (<http://isg-scra.org/STEP/STEPWhitePapers.html>)
  - a) RAMP/STEP Site Prove-outs Phases 1 & 2 - AP224/AP203
  - b) RAMP/STEP Commercial Pilot @ Texas Instruments - AP224/AP203
  - c) RAMP @ Focus:HOPE - AP224/AP203
  - d) STEP for Small/Medium Manufacturers Pilot - AP203

#### **SCRA – NAVSEA**

- STEP Shipbuilding AP Development – AP’s 215, 216, 218 (to DIS)

#### **SCRA – TACOM TARDEC**

- N-STEP – National Automotive Center Standard Exchange of Product; STEP Manufacturing Suite (See Appendix A Document 14); Pathfinder STEP Project for the U.S. Army

#### **SCRA – ARDEC**

- Lean Munitions; STEP-Enabled project using AP224 and AP240 to support U.S. Army Munitions and Armament mission areas; now in the third year and has been selected to go to full production implementation

#### **SCRA – TACOM GSIE**

- AGILE; STEP-Enabled project using AP224 and AP240 to support U.S. Army industrial depots and arsenals

#### **Siemens NG (Germany)**

- Siemens Information Technology for Industrial Plants - AP212

#### **European Projects (Many of these projects are funded by ESPRIT.)**

- **European STEP Centres Network (ESCN)** - (<http://www.uninova.pt/~escn/prodlinks.html>)

(Many of the following projects are cited at the above web site.)

- **EPISTLE : European Process Industries STEP Technical Liaison Executive** - Data Model used by for AP221, AP227, AP231
- **PIPPIN : Pilot Implementation of Process Plant Lifecycle Data Exchange Conforming To STEP** - AP221
- **PROCESSBASE : Contributions to STEP AP221**

- **SEASPRITE : Software architectures for ship product data integration and exchange.** Electronic data exchange in the shipbuilding industry using STEP AP216 & AP218.
- **FunSTEP :** Furniture STEP Development of a data model based on STEP for the manufacturers - customers integration in furniture industries.
- **CIMSTEEL : Computer Integrated Manufacture for constructional STEELwork - AP230**
- **PISTEP : Process Industries STEP - AP221 & AP227**
- **PdXi : product data eXchange institute -** has lead development of AP231
- **Petrotechnical Open Software Corporation & Caesar Systems, Ltd (POSC/Caesar) -** project to develop "STEP-like" standards for the Oil and Petrochemical Industries
- **SEDRES – System Engineering Representation and Exchange Standardization (AP233)**
- **STEP-NC (ESPRIT) (AP238 & ISO 14649) <http://www.step-nc.org>**

### Japanese Projects (involving STEP) for the Process Industries

- Power Plant STEP Working Group
- Plant CALS/STEP

## A Native Prototype AP210 3-D Package Modeler

*Seth, A.<sup>1</sup>, Thurman, T.R.<sup>2</sup>, Mukhopadhyay, D.<sup>1</sup>, Tang, D.<sup>1</sup>, Stori, J.A.<sup>3</sup>, Ferreira, P.M.<sup>1</sup>*

<sup>1</sup>**Dept. of Mechanical & Industrial Engineering, University of Illinois at Urbana-Champaign**  
1206 West Green Street, MC-244, Urbana, IL, 61801, U.S.A.

<sup>2</sup>**Rockwell Collins**

400 Collins Road N.E., Cedar Rapids, IA, 52498, U.S.A.

<sup>3</sup>**SFM Technology, Inc.**

202, W. Green Street, Urbana, IL, 61801, U.S.A.

### Motivation

The creation of electronic products integrated with mechanical sub-systems to create hybrid products such as those encountered in automotive, aerospace and military systems and products requires the ability to design and manufacture both electronic and mechanical sub-systems and to manage the interactions and interfaces between these sub-systems during design and prototyping and at manufacture in order to avoid need for redesign. This project was an attempt to design and develop a prototype integrated electro-mechanical CAD package modeler for the direct population of AP210 files with geometrical and functional design information for electrical components. The CAD tools available for electronic package design so far have been limited to the generation of purely electrical design models and, usually unrelated, non-parametrized mechanical 2-D drawings or 3-D solid models. Such models require manual cross-interpretation while using them for electro-mechanical analysis. Support for a standard protocol of data exchange at the electro-mechanical level has been vitally lacking. Different levels of detail are needed for different tasks in the electro-mechanical design process. The weakest aspect in the use of CAD and CAE tools for the electro-mechanical domain has been integration. The aim of this research was to develop a tool capable of capturing both electrical and mechanical functionality during the design phase of a package model. By virtue of such a modeling approach, component suppliers could potentially populate AP210 models with component data and geometry, pin-mapping, terminal properties, material properties, connection zones, reference shapes of solder mask junctions and footprint information. We have integrated a commercial MCAD modeling environment with additional code and data structures to successfully generate a valid AP210 file. The availability of a native AP210 modeler provides access to detailed and realistic package models to perform extensive electro-mechanical, thermal, structural and impedance analysis on PCBs, DFM analysis, modeling of constructs such as keep-out areas for features (useful for example, in lead-free initiatives requiring accounting for tin whiskers), and high-end

simulation. We exploit the ability of AP210 to support storing multiple representations appropriate for input to multi-disciplinary engineering analysis. The approach commonly used in generating AP210 information is one of collection of required data from multiple sources followed by ‘conversion’. The robustness of such an approach is always in question, but is often the only viable approach. Due to the historically divergent requirements for Mechanical and Electrical libraries for electro-mechanical components there is a lack of explicitly mapped orientation information, making conversion particularly difficult in this case.

### Methodology:

The objective was the develop a modeler for electronic packaged components native to STEP AP210 that would provide an interface that allows users to quickly define the many geometric constructs (such as leads, seating planes, dimensions, footprint definition etc.) and certain functional capabilities of features that are called for in the standard. By providing a ‘parametric’ capability based on package technology, the modeler would allow for the rapid generation of ‘library’ objects that could be used to facilitate the population of a component library with AP210 packaged parts.

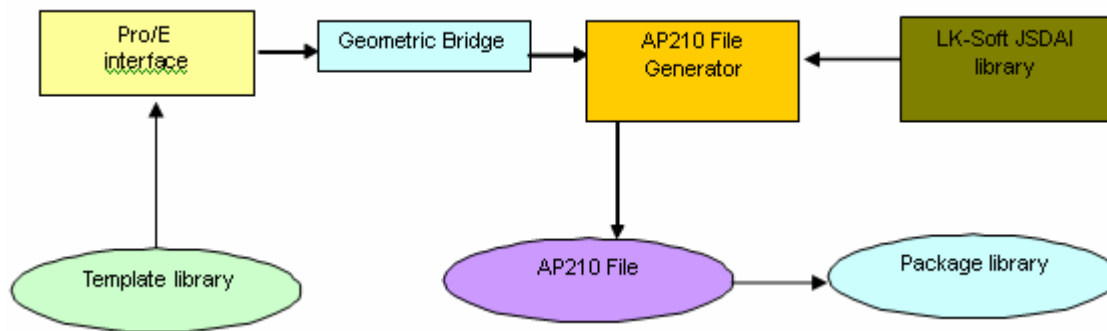

**Figure 16 — System architecture**

The approach used in this project is to develop a design environment in which the information needed for populating the AP210 model is explicitly identified during the design process. To achieve this goal, we chose a commercial mechanical CAD tool, Parametric Technologies Corporation’s Pro/Engineer®. Based on the model requirements of an AP210 package, a set of model templates was designed using Pro/E’s parametric modeling capabilities to create a user interactive capability that guides the design of a packaged item through the specification and assembly of the package information. This approach using templates, also allows for the systematic organization of model data for easy access and conversion during the generation of the AP210 file. This is accomplished by a suite of routines assembled under what we call the ‘Geometric Bridge’ that uses PTC’s Java interface (J-Link) (See Figure 16). The AP210 file generator (that uses LK-Soft’s JSDAI, a Java-based standard data access interface library for STEP) then produces the AP210 file for a packaged component. This approach has allowed us to leverage the strong user interface and parametric template capabilities of a commercial mechanical modeling environment and comprehensive and standardized data model of AP210 to create a single design environment. Further, it allows for the generation and use of package libraries. What is particularly appealing about this process is that it links various 2-D libraries for generating footprints, keep-outs, etc. directly into a single model. It allows for easy regeneration and maintenance of consistency of shape data. As with any prototype implementation, our emphasis was on demonstrating solutions to the major obstacles in a full-scale implementation. For the purposes of this project, the working draft (WD) 48\_8 of the AIM schema of the second edition was used.

### Test Cases and Results:

To demonstrate and validate the package modeler’s capabilities, multiple prototype generic package assemblies were generated and verified. The generated AP210 file can be (partially) verified by loading it back into Pro/E using the AP-203 reader. This checks the correctness of the geometry and topology associated with the manifold objects (advanced b-rep object in Part 42 of STEP), but does not verify the feature information specific to AP210. To check the correctness of the AP210 data model populated, the generated file was loaded into three externally available STEP validation tools and a validation check of the generated model was performed against the schema definition constraints. Three tools, namely the PD-Tec Instance Explorer, the Espresso Express Engine, and the EPM Technology Express Data Manager were used to check the consistency of the files generated for the example package. The PD-Tec tool for example, check all the constraints defined in the AP210 schema such as *Local rules*, *unique rules*, *inverse constraints*, *Global rules*, *required explicit attributes assigned*, *super-type constraints*, *attribute type constraints* and an *attribute instances check*. In the tests conducted, a generated file for a sample package passed the consistency check with one exception each on the PD-Tec tool and the EPM tool. In both cases, the implementation was cross-checked and it was concluded to be an inconsistency in the schema rather than an implementation error. In all cases, the mapping table for the AP210 schema has been strictly adhered to, which is the overruling standard in case of any conflicts. The generated files also passed the most critical validation test by being loaded into and viewed using LK-Soft’s STEP-Book®, a commercial tool to visualize AP210 files.

Future directions for this work include extending the implementation to handle surfaces and curves, include more options for the package template tool, allow parametric generation of lead shapes, storage of parametric data tables in the standard model, a more robust user-interface, implementation of a more complete package model with all necessary data captured at user-interface, updating the application to the published version of the 2nd edition of AP210, and implementation of the data model for connectors and connection zones.

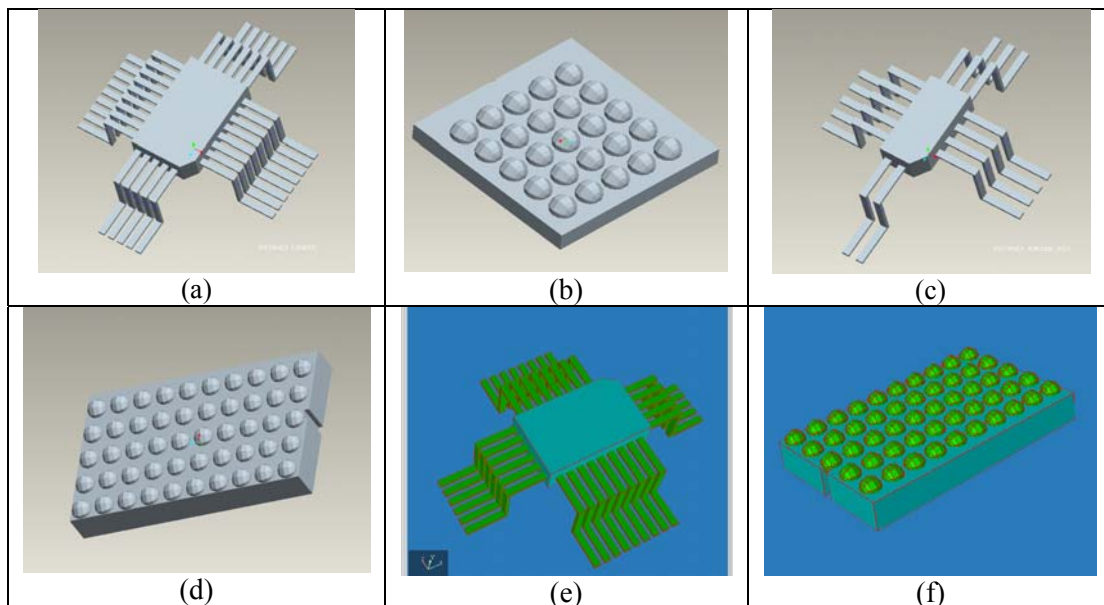

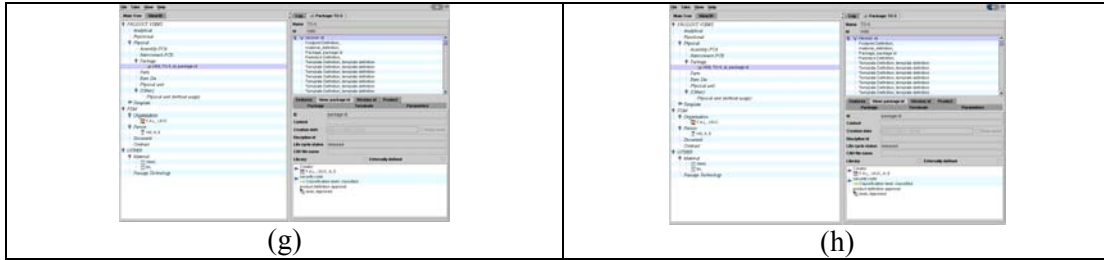

Fig. 2: (a) 3-D view of a sample QFP assembly (b) 3-D view of a sample BGA assembly  
 (c) Variant instance created using QFP template (d) Variant instance created using BGA template (e)  
 QFP package as viewed in STEP-Book (f) QFP package BOM structure in STEP-Book (g) BGA package as  
 viewed in STEP-Book (h) BGA package BOM structure in STEP-Book

## Figure 17 — Prototype AP210 3-D Package Modeler

### Conclusions:

A prototype native AP210 package modeler has been developed leveraging the strengths of the geometric modeling and user interface capabilities of Pro/E and the AP210 population routines of the LK-Soft JSDAI. With this tool, it is hoped to provide designers with the ability to directly generate AP210 native files without having to go through non-standard third-party file formats. Case studies for representative package assemblies have also been developed and tested using multiple resources. The modeler is an important tool in integrating mechanical and electrical domains and ensuring the consistency of the data in these two domains. The prototype implementation suggests that such an environment can readily be developed for use in industrial applications. This work was supported by the National Institute of Standards and Technology (NIST) under Award No. COM NA1341-03-W-0985.

## 6 Production Implementations of STEP

### Production STEP Implementations resulting from PDES, Inc. Pilot Projects:

([http://pdesinc.aticorp.org/step\\_overview.html](http://pdesinc.aticorp.org/step_overview.html)) --- See Press Release Archives for more detail and projected cost/time savings.

- **CSTAR - C-17 STEP Transfer And Retrieval** - Went production in 1995 at McDonnell Douglas (now Boeing) using AP203 cc1
- **AEROSTEP/PowerSTEP** (Boeing) - Went production in 1995 with Rolls Royce (Catia/CADDS5 - AP203 cc6) - Went production in 1996 with General Electric and Pratt & Whitney (Catia/UG - AP203 cc6) - In 1997 entered into agreement with Rolls Royce, General Electric, and Pratt & Whitney to exchange data using STEP AP203 to support digital pre-assembly verification for the 777 and 767-400 aircrafts.
- **General Motors STEP Translation Center** - Went production in 1996 to test and validate surface and solid model data exchange. Extensive STEP/IGES comparison analysis. CATI/UG translation services with GM Powertrain, Delphi/Delco Electronics, and Delphi Automotive divisions.
- **Lockheed Martin - Tactical Aircraft Systems** - Went production in 1998 with the use of CATIA STEP AP203 translators for data exchange on the F-16, JSF, F-22, KTX-2, and F-2 aircraft Programs. In 1999, Lockheed Martin-Tactical Aircraft Systems (LM-TAS), undertook the Virtual Product Development Initiative for Finite Element Analysis (VPDI-FEA) using AP209 DIS.
- **NASA** - Statement of policy that STEP Translators are required to be available at all NASA Sites

- **EuroFighter** – The members of the EuroFighter Aerospace Consortium (Alenia Aerospazio, BAe Systems, EADS-Germany, and EADS-CASA) have developed translators to convert internal data definitions to conform with the agreed upon STEP PDM Schema. The PDM systems for which the translators were developed included Metaphase, Enovia, and Optegra. The companies put these translators into production during 2001 for the EuroFighter Typhoon aircraft.
- **SCRA has supported STEP-Driven Manufacturing in production at Anniston Army Depot since 1994.** - The primary APs used at Anniston are AP224, AP203, and AP240 and the SCRA software products that implement the APs are STEPTrans (AP224 and AP203), STEPValidator (AP224 and AP203), and STEPPlan (AP224). Anniston uses this STEP-Enabled manufacturing capability daily to support the refurbishment of Army weapons systems, such as the Abrams main battle tank.

- **AP210 DFX Rule Environment**

*Stori, J.A.<sup>1</sup>, Thurman, T.R.<sup>2</sup>, Ferreira, P.M.<sup>3</sup>, Seth, A.<sup>3</sup>, Mukhopadhyay, D.<sup>3</sup>, and Tang, D.<sup>3</sup>*

<sup>1</sup>**SFM Technology, Inc.**

202, W. Green Street, Urbana, IL, 61801, U.S.A.

<sup>2</sup>**Rockwell Collins**

400 Collins Road N.E., Cedar Rapids, IA, 52498, U.S.A.

<sup>3</sup>**Dept. of Mechanical & Industrial Engineering, University of Illinois at Urbana-Champaign**

1206 West Green Street, MC-244, Urbana, IL, 61801, U.S.A.

## **Introduction**

The benefits of integrating manufacturability and testability feedback throughout the product development process have been well established. In the design and production of electronic products, providing feedback to designers early in the design cycle can significantly improve product quality, decrease costs, and reduce product development cycle times. Detailed manufacturability analysis toward the end of the design cycle is critical to assuring compatibility with available fabrication capabilities and/or facilitating cost-effective and efficient interactions with electronics manufacturing service (EMS) providers. EMS providers rely on detailed DFM analysis to identify problems prior to production and avoid unnecessary rework.

One of the first production deployments of an end-user application based on AP210 technology is the Rockwell Collins, Inc., (RCI) DFX tool developed at the University of Illinois (UIUC) through a research collaboration between RCI and UIUC. SFM Technology, Inc. has obtained a license from UIUC to commercialize this tool, and is providing production support and maintenance to RCI. The DFX tool implements a comprehensive series of 100+ parameterized DFX rules spanning design-for-assembly (DFA), design-for-manufacture (DFM) and design-for-testability (DFT) that have been customized to meet RCI's internal producibility and testability requirements.

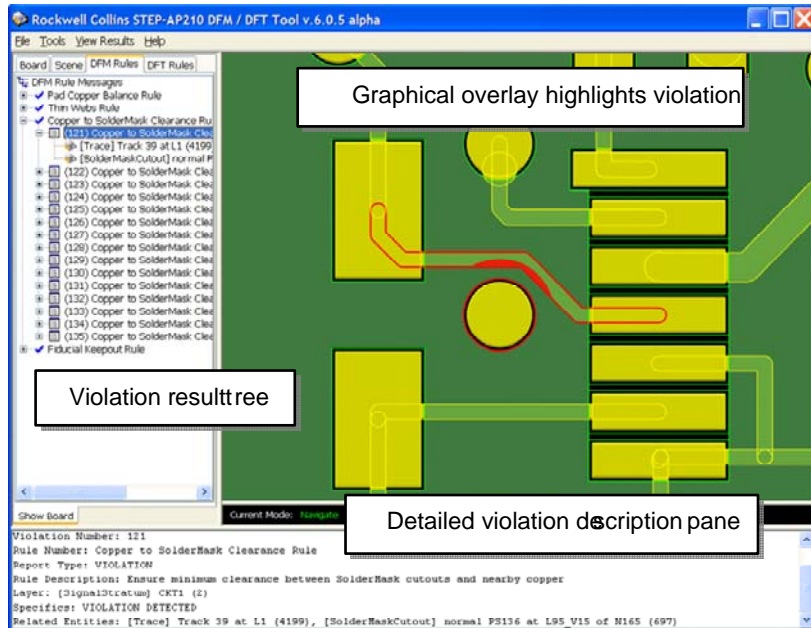

**Figure 18 — Rule Result Browsing Interface**

### 6.1.1 DFX Tool Overview

At the core of the DFX tool is an internal data model based on AP210 that supports a comprehensive set of analysis requirements for the domains of DFA, DFM, and DFT. In addition to the base design entities and physical realization of the PCB layout (traces, lands, vias, signal, solder mask, and dielectric layers, etc.), the data model supports key AP210 constructs such as padstacks, stratum features, layer connection points, and physical networks as well as the extensive interconnectivity provided by AP210 between the model entities.

The process flow is outlined in Figure 18. The rules engine is driven by an AP210 data model that unifies the native ECAD design data with component library data. Further inputs to the rule engine are provided by a web-services interface that communicates relevant manufacturing process data from external data sources. The rule engine can be executed through either an on-line interactive graphical user interface (GUI) environment or off-line in a batch mode for subsequent review of the results through graphical browsing or text-based reports.

The rules are built around a comprehensive geometric library developed at the University of Illinois that supports boundary based analysis including proximity, offsetting, and intersection, as well as bitmap based analysis such as flood fills and connectivity.

Figure 19 illustrates the graphical environment for the browsing of rule results. The rule results are maintained in a familiar tree-based interface. Browsing of an individual violation instance includes direct visual feedback of violation geometry combined with a detailed textual description of the violation instance, including references to the entities involved, and quantitative measures (such as clearance or overlap distances) when relevant.

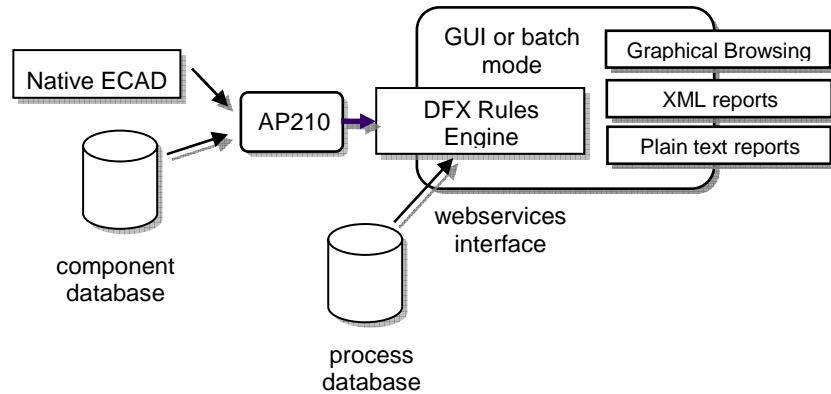

**Figure 19 — DFX Process Flow**

### 6.1.2 Production Deployment at Rockwell Collins, Inc. (RCI)

The DFX tool is currently in production use at RCI with a rule set of 48 DFM/DFA and 61 DFT rules developed to RCI internal specifications. The process flow has been validated through application to hundreds of production designs originating in Zuken’s Visula and CR-5000 ECAD tools. LKSoft’s CADIF to AP210 converter has been used to populate the AP210 files and integrate the PCA component library information from RCI internal databases, and LKSoft’s JSDAI is used internally by the DFX tool for the importing and parsing of the AP210 models.

Commonly encountered designs involve tens-of-thousands of design primitives (lands, traces, and other copper regions) on the outer layers, and the processing time for the complete rule-set is typically on the order of 5-10 minutes using a single processor PC running in either a Windows or Linux environment. SFM Technology, Inc. is generalizing and enhancing the rule-set and system capabilities for broader commercial deployment, as well as addressing unique application requirements for high-value domain-specific analysis. For additional information, please contact:

SFM Technology, Inc.  
 202 W Green St.  
 Urbana, IL 61801  
 217-344-8078  
[info@sfmttech.com](mailto:info@sfmttech.com)



## 7 Guidance on Using STEP

**In theory**, the scopes of the Application Protocols and the defined Conformance Classes indicate the coverage of the various application domains. Numerous pilots, prototype implementations, and prove-out activities have taken place (especially over the past few years) lead by groups such as PDES, Inc. and ProSTEP and internationally funded projects in Shipbuilding and the Process Industries as well as by the U.S. Army, supported by SCRA.

**In reality**, STEP in general use consists primarily of several conformance classes of AP203 (primarily cc6 and a subset of cc1, although most vendors have also implemented cc's 2 & 4) and cc1 and cc2 of AP214 which is essentially AP203 with a somewhat different set of CM data. These are the AP/cc implementations that most of the CAD/CAM Vendors have chosen to implement.

There are a limited number of production implementations of other STEP APs that involve part fabrication. One example is the United Kingdom RAMP (UKRAMP) implementation of AP224. However, Vendors have been slow to implement other AP's and will be until the User Community (i.e., their customers) requests these STEP translation capabilities in significant enough numbers.

So, at this point in time (from a production user point of view), when "we" talk about STEP, we really mean AP203 (cc's 1,2,4 & 6) and/or AP214 (cc's 1 & 2). However, we are now at a point in time when many of the other STEP AP development efforts are coming to completion. At this time, 22 APs have been published as full International Standards. So, soon, when we talk about STEP, we (as "users") will have to be more specific --- we will have to "call out" the STEP AP and the conformance classes in which we are interested. STEP is more than AP203 and its "equivalents". This will put the vendor community in a quandary --- what STEP AP's will they implement? More specifically, what conformance classes of what AP's will they implement? These decisions will be "user"/customer driven! Implementing multiple STEP AP's (i.e., numerous conformance classes for numerous AP's) will potentially be a huge undertaking for the vendors and require a significant investment of time and resources to accomplish. Certainly a strong business case will have to be established for the vendors to undertake this effort. The "user" community will have to "step to the table" with money in their hands to make it happen. It is almost certain that many of the STEP AP's (regardless of achieving IS status) will never be implemented as commercially available translators by the vendors. Some of these STEP AP's will get implemented "internally" within companies and shared with their supply chains in cases where the company feels that the costs are justified by the anticipated return on investment.

It is highly unlikely that AP201 (IS in 1994) (STEP's "equivalent" of IGES's draughting specification) will ever be implemented by anyone. PTC has the only implementation of AP202 (IS in 1996), but other Vendors appear to be considering implementing the AP214 Draughting conformance classes (cc's 3, 4, and/or 10) which have been harmonized with AP202.

Probably the STEP AP with the greatest "visibility"/"momentum" at this point in time is AP239, Product Life Cycle Support. Many companies worldwide have expressed an interest in implementing this AP.

In addition to ITI's commercially available AP210 Translator for Mentorgraphics' BoardStation layout design system, it is projected that Cadence and Zuken-Redac will follow with AP210 implementations of their own. It is not clear, at this point, what conformance classes have been or will be addressed by these translators.

A "commercially" available implementation of AP224 (through the various stages of ISO development - CD, DIS, FDIS and IS) developed by SCRA has been available for several years and in production at

several sites. This is a Pro/ENGINEER to AP224 translator. (Recall: AP224 is/has a single conformance class.) This implementation is in use in the United Kingdom as part of the Ministry of Defence's UKRAMP Program and has been integrated with their process planning system. Currently, no other commercial or production implementations of AP224 are known. Several Vendors have indicated possible interest in implementing AP 224 (including PTC and UGSolutions); none have initiated development to date. All are looking for a "business case" to arise. Such a business case may arise based on the integrated manufacturing suite scenario cited earlier (see section 2.9).

The Shipbuilding and Process Industry Suites represent a significant user community throughout the world. These activities have had strong interest and support. There is high expectation that the STEP AP's that support these efforts will be applied in these respective industries. Still to be determined is the intent of the vendor community to provide the STEP data exchange translators to cover these application domains. Once again, an industry driven business case will have to be presented in order for the vendor community to develop commercial translators for selected conformance classes of these AP's.

So, the question of **when** to use **what** AP and **why** depends, at this point, on the development status of the various AP's and the availability on the CAD systems of interest. The only commercially available STEP translators address geometry and some configuration management data (Essentially AP203 cc's 2, 4, 6 and a subset of cc 1). There is considerable "experimenting"/testing going on with prototype implementations of STEP AP's that have reached varying stages of completion in the development and standardization cycle. There is some experimentation going on in the CAx-IF with "STEP" Application Modules (e.g., colours and layers, validation properties, associative text,...) in combination with AP203. The Application Module (AM) Architecture is being worked hard with the anticipation that Vendors would be more willing to implement "small" "plug and play" modules that can leverage common elements of numerous AP's and be combined in different combinations to achieve functionality equivalent to Application Protocols. STEP AP's currently under development are being encouraged to use the Application Module approach. AP's 203 (Edition 2) and AP233/PAS 20542 are doing this.

The user is encouraged to examine the scopes and associated conformance classes of the STEP Application Protocols that have reached IS status (and those about to reach IS status) to determine which, if any, will meet data exchange needs. Then, a review of the commercially available STEP translators, and the conformance class(es) implemented will determine if a STEP solution is available.

The PDES, Inc. STEPnet and PDMnet and ProSTEP Round Table/Rally testing have done much to ferret out and resolve translation problems and to stabilize the commercial translators for AP203 and AP214 (cc's 1 & 2) and to reach consensus on the STEP PDM schema. Reliability and performance have improved greatly and led to some recommendations and hints.

(From the PDES, Inc. Public Web Site) (<http://pdesinc.aticorp.org>)

"The CAx Implementor Forum is a joint testing effort between PDES, Inc. and ProSTEP. The objective of the forum is to accelerate CAx translator development and ensure that user's requirements are satisfied. The CAx Implementor Forum is an approach to establish a common test activity in the CAD area by merging PDES, Inc.'s STEPnet and ProSTEP's CAD Round Table. The goals of the CAx Implementor Forum are to:

- Implement functionality for today's needs
- Identify functionality for tomorrow's needs
- Avoid roadblocks by establishing agreed upon approaches
- Increase user confidence by providing system and AP interoperability testing

- Ensure new functionality does not adversely impact existing implementations

The CAx Implementor Forum and PDM Implementor Forum are significantly improving STEP translator quality and decreasing translator time-to-market."

Poor model quality, not STEP itself, remains one of the major barriers to the production use of STEP. "Many STEP translation failures and errors occur due to user modeling practices and/or CAD System algorithm errors."

**"A Check List for Data Exchange** (From Theorem Solutions Web Site) (<http://www.theorem.co.uk>)

- During the dialogue between receiver and sender the following points need to be covered:
- Define the purpose of the transfer, e.g. design modification, machining.
- Define number of models/drawings.
- Define the volume of data to be converted.
- Define scope of transfer, e.g. 2D/3D or both
- Associativity to be maintained?
- Define acceptance limits for the transfer.
- Check Drawing Office practices.
- Check the magnetic media to be used.
- Check the operating system environments, i.e. UNIX, NT or other.
- Agree which data compression utilities (if any) will be used.
- Check CAD systems and versions.
- Check versions of the converters to be used.
- Is a process required to be established or is it a one-off transfer?
- For each converter to be used check:
  - Which CAD entities are covered by the converter.
  - Check which entities will be created from each CAD entity translated.
  - What options does the converter have?
  - What version of data is created?

If a standards-based solution is used, requiring two processors, check:

- Which entities are converted to CAD entities.
- Check which CAD entities are created from each neutral file entity translated.
- What options do the pre- and post-processors have?
- What version of the neutral format can be read. "

**"General Information and Techniques for Improving STEP Translation Success**

(From the PDES, Inc. CAx-IF Website @ <http://www.cax-if.org/bestprac/practice.html>)

**Modeling**

- Use entity types that are supported by your translator or defined in exchange agreements
- Wherever possible use basic geometry and primitive solids to create the model
- Avoid modeling practices that can create geometry which cannot be exchanged, as in constructing solids where topological edges converge at a single degenerate point
- Use the highest precision when creating a part
- Most CAD vendors today implement AP 203 (configuration managed 3D design data), Conformance classes 2, 4, and 6
  - Class 6 is advanced boundary representation solids

- Class 4 is topologically bounded surfaces
- Class 2 is geometrically bounded wireframe and surfaces
- AP 214 implementations so far have mainly copied AP 203 geometry
- Use b-rep solids since faceted boundary representation solids corresponds with the little-implemented AP 203 class 5
- If you must use wireframe, make it geometrically bounded since topologically bounded wireframe corresponds with the virtually unimplemented AP 203 class 3

#### **Importing STEP Files**

- Confirm that files are defined to the agreed standard
- Verify that files have not undergone any conversions that may have corrupted them, e.g. ASCII to EBCDIC conversion can convert special characters, which have a meaning in STEP files
- Ensure that files have not been truncated, e.g. to 80 character records, or in length

#### **Exporting STEP Files**

- For assemblies, confirm that all component files are in the same directory
- Make all geometry visible and selectable
- Remove unnecessary geometry, layers, annotation from the file(s)
- Use tools available in the native system to validate geometry prior to export
- Ensure that the STEP translator can support the nature of the data to be exchanged"

#### **Some User Guidelines/Hints/Analysis Websites:**

- PDES, Inc.** Best Practices Guidelines (PDES, Inc. - Public) <http://www.cax-if.org/bestprac/practice.html>
- **ProSTEP** Best Practices Guidelines (ProSTEP Public) <http://www.prostep.org/en/services/bp/> (in German)

## **8 STEP Translator Implementors Forum**

Some sort of "Official" Certification for STEP Translators has always been a goal of the ISO STEP community. The definition of certification has been an issue. Is it simply semantic and syntactic conformance to the AP's schema and STEP's syntax? The requirement for and the development of Abstract Test Suites (ATS) provide the basis for certifying a STEP translator for a specified conformance class of a specified AP.

Agreements have been reached within the ISO TC184/SC4 STEP community on what constitutes certification of a STEP translator and an agreed upon process for determining certification. A 1999 Memorandum of Understanding (MOU) signed by the four STEP Centers: PDES, Inc. (USA), GOSET (France), JSTEP Japan), and C-STEP (China) supporting STEP Certification. The U. S. Product Data Association (USPRO) has been designated as the administrator for the STEP Certification Program and the Center for Electronic Commerce (CEC) at the Environmental Research Institute of Michigan (ERIM) has been designated to conduct the certification testing and to validate the results.

The procedures are designed to be performed electronically with a mechanism for conducting sample self-testing prior to initiating the "real" certification test. Translators can be certified as preprocessors (generating STEP files) and/or as postprocessors (reading in the STEP file). Official STEP Certification testing was initiated in 1999 and to date, seven (7) Vendor translators have been bi-directionally certified for AP203 cc 6a where the "a" designates the "agreed upon" minimal subset of cc1 configuration management data. The certified translators are Dassault's CATIA 4.2.2, UGSolutions' UNIGRAPHICS v16, Autodesk's Mechanical Desktop 4.1, Theorem Solutions' CADD5 v4.0, SolidWorks 2000, Alibre's Design, and MSC's Patran 2001 r1.

The **CAX Implementor Forum** is a joint testing effort between [PDES, Inc.](#) and [ProSTEP iViP](#). The objective of the forum is to accelerate CAX translator development and ensure that user's requirements are satisfied. The CAX Implementor Forum is an approach to establish a common test activity in the CAD area by merging PDES, Inc.'s STEPnet and ProSTEP iViP's CAD Round Table.

The goals of the CAX Implementor Forum are to:

- ▶ Implement functionality for today's needs
- ▶ Identify functionality for tomorrow's needs
- ▶ Avoid roadblocks by establishing agreed upon approaches
- ▶ Increase user confidence by providing system and AP interoperability testing
- ▶ Ensure new functionality does not adversely impact existing implementations

The CAX Implementor Forum and [PDM Implementor Forum](#) are significantly improving STEP translator quality and decreasing translator time-to-market.

*For more information on CAX Implementor Forum, send email to: [CAX-INFO-L@CAX-IF.ORG](mailto:CAX-INFO-L@CAX-IF.ORG)*

The **PDM Implementor Forum** is the STEP interoperability test bed for PDM systems.

The PDM Implementor Forum is a part of a comprehensive infrastructure where STEP developers and users conduct interoperability testing over the internet.

The PDM Implementor Forum is an activity of the combined STEP testing forum between PDES, Inc. and ProSTEP.

The PDM Implementor Forum and the [CAX Implementor Forum](#) are significantly improving STEP translator quality and decreasing translator time-to-market.

## 9 Summary

The development and implementation of STEP Standards is dynamic and on-going. This handbook represents a “snap shot” of the information as it exists at this point in time.

This handbook is a collection of information on the current state of STEP and it's current usability. It's intent was to provide information of value to engineering users with a need to exchange product data with customers and/or suppliers.

The handbook concentrated on identifying the application domains being covered by STEP development, identifying commercially available tools for using STEP, providing guidance on using the STEP technology that is currently available, and providing sources of additional information.

The current status of STEP development was presented with emphasis on those parts of STEP that have achieved International Standard (IS) status and those parts that will soon reach that status. The scopes of these STEP Application Protocols (AP's) are presented to indicate what is and isn't addressed in the AP's. This information was presented so that the engineering user was able to see the depth of coverage of the AP's and to identify those STEP AP's and their associated conformance classes that best will meet the user's product data exchange (PDE) requirements.

A table is provided showing commercially available PDE translators from the major CAD/CAM vendors. This table includes STEP translators as well as direct translators and translators that use other PDE formats.

At this point in time, commercial implementation of STEP is mainly limited to several conformance classes of AP203 - Configuration Controlled Design and two conformance classes of AP214 - Core Data for Automotive Mechanical Design Processes which are roughly equivalent to AP203. Reference is made to those major companies who have put this current STEP capability into production.

Numerous pilot, prototype and proof-of-concept implementations of the many STEP Application Protocols were cited to emphasize the successful demonstration of the power and robustness of the evolving STEP standards.

An attempt was made to distinguish between what is "real" now and what is theoretically possible (& achievable) in the future and to identify some of the current obstacles to achieving the ultimate goal of STEP. (i.e., to provide a complete, unambiguous, neutral computer-interpretable standard for representing product data throughout the lifecycle of the product.)

Some guidance was provided for the engineering user in using the currently available STEP capability. Some hints, guidelines and checklists were provided and referenced to assist in using the currently available STEP technology.

The STEP that is commercially available to the engineering user community is essentially AP203 and its "look alike" AP214 cc 1&2 (i.e., geometry (wireframe, surfaces & solids) with some configuration management data). What is available is really very good --- good enough to be in production at Boeing, Lockheed Martin, General Motors, General Electric, Pratt & Whitney, Rolls Royce and other large companies. But STEP presents a much more powerful and robust technology that has been and is being demonstrated in numerous Research & Development environments.

STEP is frequently misunderstood in the general engineering user community. It is still evolving, and STEP is now at a point in its evolution when a significant number of Application Protocols are reaching International Standard status, with 22 APs having been published as ISs to date.. The user community will now have to start looking more closely at the AP's and their associated conformance classes (cc's) to determine what components/parts of STEP best meet their requirements. Users are going to have to start referring to STEP by AP and cc. In order to realize the "full" power of STEP, the user community will have to drive vendor implementation of the AP conformance classes that they will need to meet their business objectives. In order for this to happen, strong business cases are going to have to be developed in order to get the CAD/CAM/CAE Vendors on board.

## 10 APPENDICES

### 10.1 APPENDIX A - Documents

1. The Economic Benefits of Advanced Product Data (Draft), DL910T1, Michelle M. Kordell & Eric L. Gentsch, Logistics Management Institute, December 1999.
2. The Applicability of STEP to Automotive Design and Manufacturing, Automotive Industry Action Group (AIAG) D-10, March 10, 1998.
3. SCRA RAMP STEP-Driven Manufacturing Prove-Out Reports: (with metrics) ([http://ramp.isg-scra.org/ap224\\_reports.html](http://ramp.isg-scra.org/ap224_reports.html))
  - a. Final Report for STEP Driven Manufacturing at Small and Medium Manufacturers Pilot Project, DLA RAMP Program, Team SCRA, July 15, 1997.
  - b. RAMP Site Proveout of STEP Filesets Project - Phase 1 (June 8, 1994 - February 24, 1995)(Final Report-General Release), TAR2017005-0, RAMP Program, Team SCRA, (Reproduced & Distributed by USPro), March, 1995.
  - c. RAMP Site Proveout of STEP Filesets Project - Phase 2 (February 25, 1995 - July 17, 1996)(Final Report), TAB2017009-0, RAMP Program, Team SCRA, March 26, 1997.
  - d. RAMP Technology Transfer Pilot Program (Final Report), Texas Instruments Defense Systems and Electronics, November 21, 1996.
  - e. Rapid Acquisition of Manufactured Parts Pilot Project (Final Report), Team SCRA & Focus:HOPE, July 31, 1997.
4. Product Data Exchange Technologies Success Story Booklet, IGES/PDES Organization (IPO) Workshop, Gaithersburg, Maryland, January 27, 1997.
5. The Historical Need for STEP (A White Paper), Howard Mason (British Aerospace)
6. STEP Development Methods, (A White Paper), Julian Fowler (CADDETC-Fomerly), March 7, 1995.
7. STEP:Towards Open Systems-STEP Fundamentals and Business Benefits, Dr. Kais Al-Timimi & John MacKrell, CIMdata, September, 1996.
8. Introducing STEP - The Foundation for Product Data Exchange in the Aerospace and Defence Sectors, National Research Council Canada, C2-447/1999, Susan Gilles (ed), 1999. <http://strategis.ic.gc.ca/epic/internet/inad-ad.nsf/en/ad03581e.html>
9. STEP-The Grand Experience, NIST, Sharon J. Kemmerer (ed.), July 1999
10. STEP-The Future of Product Data Exchange (An AIAG Booklet), Dick Justice, Russell Doty & Mike Strub, 1995.
11. On-demand manufacturing of Printed circuit assemblies Using STEP (OPUS), W. B. Gruttke, W. B. Freeman, C. T. Lanning & K. D. Buchanan, EMI International, April 1999.

12. STEP-Driven Manufacturing, CASA/SME Blue Book Series, John H. Bradham, 1998.
13. Fundamentals of STEP Implementation, Dave Loffredo, STEP Tools, Inc., <http://www.steptools.com/library/fundimpl.pdf>
14. STEP Manufacturing Suite, (A White Paper), Team SCRA, 30 September 2001, [http://isg-scra.org/STEP/files/STEP\\_MfgSuiteWhitePaper.pdf](http://isg-scra.org/STEP/files/STEP_MfgSuiteWhitePaper.pdf)
15. “AP213: Numerical Control (NC) Process Plans for Machined Parts” (A White Paper for ISO TC184/SC4), L. Slovensky, K. Yee, W. Simon, June 2000
16. “Integrating Product Data Standards”, Len Slovensky, Plant Services, August 2000
17. “STEP into Automatic Machining”, (STEP-NC White Paper), Martin Hardwick, STEP Tools, Inc., August 2001, <http://www.manufacturingcenter.com/tooling/archives/0202/0202technotebook.asp>
18. STEP Application Handbook (First Edition), Team SCRA, 1 June 2000, <http://isg-scra.org/STEP/STEPHandbook.html>
19. STEP Application Handbook (Second Edition), Team SCRA, 1 December 2001, <http://isg-scra.org/STEP/STEPHandbook.html>
20. The Engineering Analysis Core Model – A ‘plain man’s guide’. David Leal, December 1999, <http://www.cedarlon.demon.co.uk/eacm/> (PDES Inc.’s Public Website – STEP Capabilities – Engineering Analysis)



## 10.2 APPENDIX B – Web Sites

1. SCRA - Product Data --- <http://isg-scra.org/STEP/index.html>

### \*\*\*\*\* STEP Centers \*\*\*\*\*

2. Portuguese STEP Center --- <http://www.uninova.pt>

3. Fujitsu STEP Research & Development Center --- <http://www.fqs.co.jp/STEP/>

4. Italian STEP Center (CeSTEP) (in Italian) --- <http://www.uninfo.polito.it/CESTEP/stepmenu.htm>

5. PDES Inc. Public Website --- <http://pdesinc.aticorp.org/>

6. ProSTEP --- <http://www.prostep.de/>

7. STEP in Finland ---

<http://cic.vtt.fi/links/step.html> (Building & Construction)

<http://cic.vtt.fi/links/euproj/index.html> (List of Projects)

8. ISO TC 184/SC 4/WG 3/T 23 (Ship team) - <http://www.nsrp.org/t23/>

9. Europe Marine e-business Standards Association - <http://www.emsa.org/>

10. Japan Ship Technology Research Association (JSTRA) - <http://www.jstra.jp/>

11. Korea STEP Center - <http://kstep.or.kr/>

### \*\*\*\*\* Standards Organizations \*\*\*\*\*

12. ANSI --- <http://www.ansi.org/>

13. ISO --- <http://www.iso.ch/iso/en/ISOOnline.frontpage>

14. ISO Standards Query --- [http://www.iso.ch/iso/en/Standards\\_Search.StandardsQueryForm](http://www.iso.ch/iso/en/Standards_Search.StandardsQueryForm)

15. NIST --- <http://www.nist.gov/welcome.html>

16. SC4 On-Line Information Service (SC4ONLINE) --- <http://www.tc184-sc4.org/>

17. US Product Data Association (USPro) --- <https://www.uspro.org/>

### \*\*\*\*\* Information, Overviews, Summaries \*\*\*\*\*

18. NIST SOAP Website (Updated 2001-11-28): --- <http://www.mel.nist.gov/sc5/soap/> --- STEP On A Page

19. PDES, Inc. STEP Part Descriptions --- [http://pdesinc.aticorp.org/whatsnew/all\\_aps.html](http://pdesinc.aticorp.org/whatsnew/all_aps.html)

20. PDES, Inc. STEP Overview --- [http://pdesinc.aticorp.org/step\\_overview.html](http://pdesinc.aticorp.org/step_overview.html)

21. ProSTEP Best Practices (in German) --- <http://www.prostep.org/en/services/bp/>

### \*\*\*\*\* Tools \*\*\*\*\*

22. EPM Technology Products --- <http://www.epmtech.jotne.com/products/index.html>

23. EuroSTEP --- <http://www.eurostep.se>

24. EXPRESS Engine (Formerly EXPRESSO) --- <http://exp-engine.sourceforge.net>

25. International TechneGroupe Inc. (ITI) --- <http://www.iti-oh.com>

26. PD Tec Products --- <http://www.pdtec.de/>

27. STEP Tools, Inc. --- <http://www.steptools.com/>

### \*\*\*\*\* Vendors \*\*\*\*\*

28. Alias Wavefront --- <http://usa.autodesk.com/adsk/servlet/index?id=5970886&siteID=123112>

29. Alibre --- <http://www.alibre.com/solutions/>

30. Autodesk Data Exchange Products --- <http://www.autodesk.com/products/dataexch/index.htm>

31. Autodesk – XchangeWorks --- (Free Plug In)

<http://www.solidworks.com/pages/products/xchangeworks/index.html>

32. CATIA/CADAM Interface Products/ IBM Data Exchange Services ---

<http://www-306.ibm.com/software/applications/plm/catiav4/prods/stp/>

33. PTC Pro/E Interfaces --- <http://www.ptc.com/products/proe/foundation/interfaces.htm>

34. SDRC (Now Part of EDS) --- <http://www.plmsol-eds.com/>

35. Solid Edge Translators: ---  
[http://www.ugs.com/partners/partner\\_pages/partnerPage.shtml?action=company&companyId=67366](http://www.ugs.com/partners/partner_pages/partnerPage.shtml?action=company&companyId=67366)  
--- <http://www.ugs.com/products/open/parasolid/portfolio/step.shtml>
36. Solid Edge Website --- <http://www.solid-edge.com/>
37. TranscendData (formerly ITI PDI) --- <http://www.transcendata.com/>
38. UGSolutions Products ---  
--- <http://www.ugs.com/index.shtml>  
--- <http://www.solidedge.com/overview/data.exchange.htm>
39. Theorem Solutions --- <http://www.theorem.co.uk/> (CADverter)  
\*\*\*\*\* Industry Group \*\*\*\*\*
40. AIAG --- <http://www.aiag.org/>  
\*\*\*\*\* Other \*\*\*\*\*
41. IMTECH View Formats --- <http://www.imtechdesign.com/3dview/index.htm>

### 10.3 APPENDIX C – STEP On A Page

ISO TC184/SC4

**STEP On A Page**

ISO 10303

#### APPLICATION PROTOCOLS AND ASSOCIATED ABSTRACT-TEST SUITES

I 201 <a href="#">Explicit draughting</a> [ATS 301 = X]	E 221 <a href="#">Functional data &amp; their schem rep for process plant</a> [X]
I 202 <a href="#">Associative draughting</a> [C]	X 222 Design-manuf for composite structures [X]
I 203 <a href="#">Configuration controlled 3D design</a> (c2=l,a1=l)[X]	C 223 <a href="#">Exch of design &amp; mfg product info for cast parts</a> [X]
I 203 <a href="#">Configuration controlled 3D design</a> (TS1=l)	@ 224 e3 <a href="#">Mech pdt def for p. plg using mach'n'g feat</a> e3
I 204 <a href="#">Mechanical design using boundary rep</a> [I]	(e2=l) [I,W]
X 205 Mechanical design using surface rep [W]	I 225 <a href="#">Building elements using explicit shape rep</a> [C]
X 206 Mechanical design using wireframe [X]	X 226 Ship mechanical systems[X]
I 207 <a href="#">Sheet metal die planning and design</a> [c1=l]	I 227 <a href="#">Plant spatial configuration</a> (e2=E) [X]
X 208 Life-cycle product change process [X]	X 228 Building services: HVAC [X]
I 209 <a href="#">Composite &amp; metal structural anal &amp; related design</a> [X]	A 229 <a href="#">Exchange of product info for forged parts</a> [X]
I 210 <a href="#">Electronic assy, interconnection &amp; packaging design</a> [X]	X 230 Building structural frame: steelwork [X]
W 210 e2 <a href="#">Electronic assy, interconnection &amp; packaging design</a>	X 231 Process-engineering data [X]
X 211 Electronic P-C assy: test, diag, & remanuf[X]	I 232 <a href="#">Technical data packaging: core info &amp; exch</a> [I]
I 212 <a href="#">Electrotechnical design and installation</a> [X]	W 233 e2 <a href="#">Systems engineering data repr</a>
X 213 Num control (NC) process plans for mach'd parts [X]	X 234 Ship operational logs, records, and messages[X]
I 214 e2 <a href="#">Core data for automotive mech design processes</a>	C 235 <a href="#">Materials info for des and verif of products</a> [X]
[X]	E 236 <a href="#">Furniture product and project data</a> [W]
A 214 e3 <a href="#">Core data for automotive mech design processes</a>	X 237 <a href="#">Computational Fluid Dynamics</a>
I 215 <a href="#">Ship arrangement</a> [X]	E 238 <a href="#">Application interpreted model for computer numeric controllers</a>
I 216 <a href="#">Ship moulded forms</a> [X]	I 239 <a href="#">Product life cycle support</a>
X 217 Ship piping [X]	I 240 <a href="#">Process plans for machined products</a>
I 218 <a href="#">Ship structures</a> [W]	
C 219 <a href="#">Dimension inspection</a> [X]	
O 220 Proc. plg, mfg, assy of layered electrical products [X]	

**COMMON RESOURCES (with 13584-20 logic. model of expr. and 15531-42 Time)**

**Legend: TS Status**  
 0-10 =O=prop-->apvl for ballot  
 10-20=A=NP blt circ-->NP apvl  
 20-60=D=DTS dev-->reg as TS  
 >60 =T=TS Published

**APPLICATION MODULES (Technical specifications)**

Because there are many of these planned SOAP has been forced to be SOAPH, STEP on a page and a half. For their listing, please access the file via the SOAP home page.

**INTEGRATED-APPLICATION RESOURCES**

- |   |  |
|---|--|
| I 101 <a href="#">Draughting</a> (c1=l)       | @ 107 <a href="#">Finite-element analysis definition relationships</a>                     |
| X 102 Ship structures                         | I 108 <a href="#">Prmetizat'n&amp;Constraints for expl geom prod mdl</a>                   |
| X 103 E/E connectivity                        | I 109 <a href="#">Assembly model for products</a>  |
| I 104 <a href="#">Finite element analysis</a> | X 110 <a href="#">Mesh based computational fluid dynamics</a>                              |
| I 105 <a href="#">Kinematics</a> (c1=l, c2=l) | E 111 <a href="#">Construction history features</a>  |
| X 106 Building core model                     | E 112 <a href="#">2d standard modeling commands for the procedural parametric exchange</a> |

**INTEGRATED-GENERIC RESOURCES**

- |   |   |
|---|---|
| I 41 e3 <a href="#">Fund of prdct descr &amp; spt</a>   | I 50 <a href="#">Mathematical constructs</a>                |
| I 42 e3 <a href="#">Geom &amp; top rep</a>              | I 51 <a href="#">Mathematical description</a>               |
| I 43 e2 <a href="#">Representation structures</a>       | X 52 Mesh-based topology                                    |
| I 44 e2 <a href="#">Product structure configuration</a> | X 53 Numerical Analysis                                     |
| I 45 <a href="#">Materials</a> (c1=l)                   | I 54 <a href="#">Classification and set theory</a>          |
| I 46 <a href="#">Visual presentation</a> (c1=l, c2=l)   | I 55 : <a href="#">Procedural and hybrid representation</a> |
| I 47 <a href="#">Tolerances</a> (c1=l)                  | I 56 <a href="#">State</a>                                  |
| X 48 Form features                                      | X 57 Expression extensions                                  |
| I 49 <a href="#">Process structure &amp; properties</a> | X 58 Risk   |
|   | W 59 <a href="#">Quality of product shape data</a>          |

**APPLICATION-INTERPRETED CONSTRUCTS**

- |  |  |
|--|--|
| I 501 <a href="#">Edge-based wireframe</a>           | I 513 <a href="#">Elementary B-rep</a>                     |
| I 502 <a href="#">Shell-based wireframe</a>          | I 514 <a href="#">Advanced B-rep</a>                       |
| I 503 <a href="#">Geom-bounded 2D wireframe</a>      | I 515 <a href="#">Constructive solid geometry</a>          |
| I 504 <a href="#">Draughting annotation</a>          | X 516 Mechanical-design context                            |
| I 505 <a href="#">Drawing structure &amp; admin.</a> | I 517 <a href="#">Mech-design geom presentation</a> (c1=l) |
| I 506 <a href="#">Draughting elements</a>            | I 518 <a href="#">Mech-design shaded presentation</a>      |
| I 507 <a href="#">Geom-bounded surface</a>           | I 519 <a href="#">Geometric tolerances</a> (c1=l)          |
| I 508 <a href="#">Non-manifold surface</a>           | I 520 <a href="#">Assoc draughting elements</a>            |
| I 509 <a href="#">Manifold surface</a>               | I 521 <a href="#">Manifold subsurface</a>                  |
| I 510 <a href="#">Geom-bounded wireframe</a>         | I 522 <a href="#">Machining features</a>                   |
| I 511 <a href="#">Topologically bounded surface</a>  | @ 522 e2 <a href="#">Machining features</a>                |
| I 512 <a href="#">Faceted B-representation</a>       | I 523 <a href="#">Curve swept solid</a>                    |

**IMPLEMENTATION METHODS**

- |  |  |
|--|--|
| I 21 e2 <a href="#">Clear-text encoding exch str</a> | I 25 <a href="#">EXPRESS to OMG XML binding</a>                  |
| I 22 <a href="#">Standard data access interface</a>  | X 26 IDL language binding (to #22)                               |
| I 23 <a href="#">C++ language binding (to #22)</a>   | I 27 <a href="#">JAVA language binding (to #22)</a>              |
| I 24 <a href="#">C language binding (to #22)</a>     | I 28 <a href="#">XML rep for EXPRESS-schemas and data</a> (e2=E) |
|  | X 29 Ltwt Java binding (to #22)                                  |

- DESCRIPTION METHODS**
- I 1 [Overview and fundamental principles](#) (a2=W)
  - I 11 e2 [EXPRESS language ref man.](#) (e3=O (ISO 20303))
  - I 12 [EXPRESS-I language ref man](#) (Type 2 tech report, not a 10303 part)
  - X 13 [Architecture and Methodology reference manual](#)
  - I 14 [EXPRESS-X Language reference manual](#)

- CONFORMANCE TESTING METHODOLOGY & FRAMEWORK**
- I 31 [General Concepts](#)
  - I 32 [Requirements on testing labs and clients](#)
  - X 33 [Structure and use of abstract test suites](#)
  - I 34 [Abstract test methods for Part 21 Implementation.](#)
  - I 35 [Abstract test methods for Part 22 Implementation.](#)

**Legend: Part Status** (E, F, I safe to implement)  
 0=O=**Preliminary Stage** (Proposal-->appr for NP ballot)  
 10=A=**Proposal Stage** (NP ballot circ-->NP approval)  
 20=W=**Preparatory Stage**(Wkg Draft devel.-->CD registration)  
 30=C=**Committee Stage** (CD circulation-->DIS registration)  
 40=E=**Enquiry Stage** (DIS circ.-->FDIS registration)  
 50=F=**Approval Stage** (FDIS circ-->Int'l Std registration)  
 @=**At ISO, approved for publication** (ISO status 40.95 or 50.99)  
 60=I=**Publication Stage** (Int'l Std published)  
 98=X=**Project withdrawn**

jgnell, 89-Oct.-23; rev. 01-11-28. Origin: ISO 10303 Editing Committee. On-line: <http://www.nist.gov/sc5/soap/>  
**Chg 1, 2004-06-19**/jpbrazy Reverse engineered SOAP to MS Word source to enable linking to SC4ONLINE Project folders.  
**Chg 2, 2006-05-05**/jpbrazy. Updated to include publications through 2005-12-31.

**Legend: TS Status**

0-10 =O=prop-->apvl for ballot  
 10-20=A=NP blt circ-->NP apvl  
 20-60=D=DTS dev-->reg as TS  
 @ At ISO, approved for publication  
 >60 =T=TS Published  
 98 =X= Project withdrawn

ISO TC184/SC4STEP AM On M Pages

ISO 10303

**COMMON Resources (with 13584-20 Logical model of expressions (I) and 15531-42 Time model (E))****Application Modules (Technical Specifications)****S AM Title**

T 403 [AP203 Configuration control 3d design](#)  
 D 410 [AP210 electronic assembly interconnect and packaging design](#)  
 T 421 [Functional data and schematic representation](#)  
 O 433 [AP233 system engineering and design](#)  
 D 436 [AP236 furniture catalog and interior design](#)  
 T 439 [AP239 Product life cycle support](#)

T 1001 e2 [Appearance assignment](#)  
 T 1002 [Colour](#)  
 T 1003 [Curve appearance](#)  
 T 1004 e2 [Elemental geometric shape](#)  
 T 1005 [Elemental topological shape](#)  
 T 1006 e2 [Foundation representation](#)  
 T 1007 [General surface appearance](#)  
 T 1008 [Layer assignment](#)  
 T 1009 [Shape appearance and layers](#)  
 T 1010 [Date time](#)

T 1011 [Person organisation](#)  
 T 1012 [Approval](#)  
 T 1013 [Person organisation assignment](#)  
 T 1014 [Date time assignment](#)  
 T 1015 [Security classification](#)  
 T 1016 [Product categorisation](#)  
 T 1017 [Product identification](#)  
 T 1018 [Product version](#)  
 T 1019 [Product view definition](#)  
 T 1020 [Product version relationship](#)

T 1021 [Identification assignment](#)  
 T 1022 [Part and version identification](#)  
 T 1023 [Part view definition](#)  
 T 1024 [Product relationship](#)  
 T 1025 [Alias identification](#)  
 T 1026 [Assembly structure](#)  
 T 1027 [Contextual shape positioning](#)  
 X 1028 Geometric shape and topology  
 X 1029 Boundary representation model  
 T [1030 Property assignment](#)

X 1031 Property representation  
 T 1032 [Shape property assignment](#)  
 T 1033 [External model](#)  
 T 1034 [Product view definition properties](#)  
 X 1035 Product view definition structure properties  
 T 1036 [Independent property](#)  
 X 1037 Independent property usage

**S AM Title**

X 1219 AP203E2\_config control 3D design CC1  
 X 1220 AP203E2\_config control 3D design CC2

X 1221 AP203E2 config control 3D design CC3  
 X 1222 AP203E2\_config control 3D design CC4  
 X 1223 AP203E2\_config control 3D design CC5  
 X 1224 AP203E2\_config control 3D design CC6  
 X 1225 AP203E2\_config control 3D design CC7  
 X 1226 AP203E2\_config control 3D design CC8  
 X 1227 AP203e2\_config\_control\_3d\_design\_module  
 T 1228 [Representation with uncertainty](#)  
 O 1229 AP203 configuration management  
 T 1230 [Configuration controlled 3D parts and assemblies](#)

T 1231 [Product data management](#)  
 O 1232 [Design material aspects](#)  
 T 1233 [Requirement assignment](#)  
 O 1236 Furniture product data and project data  
 X 1239 Product life cycle support  
 T 1240 [Organization type](#)

T 1241 [Information rights](#)  
 T 1242 [Position in organization](#)  
 T 1243 [Experience](#)  
 T 1244 [Qualifications](#)  
 T 1245 [Type of person](#)  
 T 1246 [Attribute classification](#)  
 X 1247 Classification  
 T 1248 [Product breakdown](#)  
 T 1249 [Activity method assignment](#)  
 T 1250 [Attachment slot](#)

T 1251 [Interface](#)  
 T 1252 [Probability](#)  
 T 1253 [Condition](#)  
 T 1254 [Condition evaluation](#)  
 T 1255 [State definition](#)  
 T 1256 [State observed](#)  
 T 1257 [Condition characterized](#)  
 T 1258 [Observation](#)  
 T 1259 [Activity as realized](#)  
 T 1260 [Scheme](#)

T 1261 [Activity method implementation](#)  
 T 1262 [Task specification](#)  
 T 1263 [Justification](#)  
 O 1264 Risk  
 T 1265 [Envelope](#)

**S AM Title**

T 1038 [Independent property representation](#)  
T 1039 [Geometric validation property representation](#)  
T 1040 [Process property assignment](#)

T 1041 [Product view definition relationship](#)  
T 1042 [Work request](#)  
T 1043 [Work order](#)  
T 1044 [Certification](#)  
X 1045 Solid model  
T 1046 [Product replacement](#)  
T 1047 [Activity](#)  
T 1049 [Activity method](#)  
T 1050 [Dimension tolerance](#)

T 1051 [Geometric tolerance](#)  
T 1052 [Default tolerance](#)  
O 1053 [Placed datum target](#)  
T 1054 [Value with unit](#)  
T 1055 [Part definition relationship](#)  
T 1056 [Configuration item](#)  
T 1057 [Effectivity](#)  
T 1058 [Configuration effectivity](#)  
T 1059 [Effectivity application](#)  
T 1060 [Product concept identification](#)

T 1061 [Project](#)  
T 1062 [Contract](#)  
T 1063 [Product occurrence](#)  
T 1064 [Event](#)  
T 1065 [Time interval](#)  
X 1066 Constructive solid geometry  
O 1067 [Constructive solid geometry 2D](#)  
T 1068 [Constructive solid geometry 3D](#)  
X 1069 Faceted boundary representation model  
T 1070 [Class](#)

T 1071 [Class of activity](#)  
O 1072 [Activity or state space](#)  
O 1073 [Behaviour](#)  
T 1074 [Property condition](#)  
O 1075 [Possession of property validity](#)  
O 1076 Product feature space  
T 1077 [Class of product](#)  
O 1078 [Property dictionary for structural analysis](#)  
O 1079 [Property distribution](#)  
T 1080 [Property space](#)

O 1081 [Compound property space](#)  
O 1082 [State](#)  
O 1083 [Distribution mapping](#)  
O 1084 [Product activity and state space parameterisation](#)  
T 1085 [Property identification](#)  
O 1086 [B spline function](#)  
O 1087 [Elementary function dictionary](#)  
O 1088 [Externally defined maths value](#)  
O 1089 [Linear Function](#)  
O 1090 [Maths function](#)

T 1091 [Maths space](#)  
T 1092 [Maths value](#)  
O 1093 [Shape defined function](#)  
O 1094 [Tabular function](#)  
O 1095 [Mesh](#)  
O 1096 [Mesh function](#)  
O 1097 [Structured mesh](#)  
O 1098 [Unstructured mesh](#)  
T 1099 [Independent property definition](#)  
O 1100 [Possession of property statistics and probability](#)

**S AM Title**

T 1266 [Resource management](#)  
T 1267 [Required resource](#)  
T 1268 [Resource item](#)  
T 1269 [Resource as realized](#)  
T 1270 [Message](#)

T 1271 [State characterized](#)  
T 1272 [Activity characterized](#)  
T 1273 [Resource property assignment](#)  
T 1274 [Probability distribution](#)  
T 1275 [External class](#)  
T 1276 [Location](#)  
T 1277 [Location assignment](#)  
T 1278 [Product group](#)  
X 1279 Environment  
T 1280 [Required resource characterized](#)

T 1281 [Resource item characterized](#)  
T 1282 [Resource management characterized](#)  
T 1283 [Resource as realized characterized](#)  
X 1284 Resourced activity method  
T 1285 [Work request characterized](#)  
T 1286 [Work order characterized](#)  
T 1287 [AP239 activity recording](#)  
T 1288 [Management resource information](#)  
T 1289 [AP239 management resource information](#)  
T 1290 [Document management](#)

T 1291 [Plib class reference](#)  
T 1292 [AP239 product definition information](#)  
T 1293 [AP239 part definition information](#)  
T 1294 [Interface lifecycle](#)  
T 1295 [AP239 properties](#)  
T 1296 [Condition evaluation characterized](#)  
T 1297 [AP239 document management](#)  
T 1298 [Activity method characterized](#)  
X 1299 Activity method implementation characterized  
T 1300 [Work output](#)

T 1301 [Work output characterized](#)  
X 1302 [Task assignment](#)  
X 1303 AP239 activity and resource management  
T 1304 [AP239 product status recording](#)  
X 1305 Resourced activity  
T 1306 [AP239 task specification resourced](#)  
T 1307 [AP239 work definition](#)

T 1340 [Name assignment](#)  
T 1341 [Generic expression](#)  
T 1342 [Expression](#)  
T 1343 [Product placement](#)  
T 1344 [Numerical interface](#)  
T 1345 [Item definition structure](#)  
T 1346 [Numeric function](#)  
T 1347 [Wireframe 2d](#)  
T 1348 [Requirement management](#)  
T 1349 [Incomplete data reference mechanism](#)  
T 1350 [Inertia characteristics](#)

D 1351 [Catalog data information](#)  
D 1352 [Catalog data information and shape representation](#)  
D 1353 [Parameterized catalog data information](#)  
D 1354 [Furniture interior decoration](#)  
D 1355 [Parameterized catalog data and shape representation](#)  
X 1356 Furniture catalog and interior design  
T 1357 [Selected item](#)  
T 1358 [Location assignment characterized](#)  
O 1359 Justification characterized

**S AM Title**

T 1101 [Product property feature definition](#)  
T 1102 [Assembly feature definition](#)  
T 1103 [Product class](#)  
T 1104 [Specified product](#)  
T 1105 [Multi linguism](#)  
T 1106 [Extended measure representation](#)  
X 1107 [Product management data](#)  
T 1108 [Specification based configuration](#)  
T 1109 [Alternative solution](#)  
T 1110 [Surface conditions](#)

T 1111 [Classification with attributes](#)  
T 1112 [Specification control](#)  
T 1113 [Group](#)  
T 1114 [Classification assignment](#)  
T 1115 [Part collection](#)  
T 1116 [Pdm material aspects](#)  
T 1118 [Measurement representation](#)  
O 1119 [Construction history](#)  
O 1120 [Configuration controlled 3D design](#)

T 1121 [Document and version](#)  
T 1122 [Document assignment](#)  
T 1123 [Document definition](#)  
T 1124 [Document structure](#)  
X 1125 [File properties](#)  
T 1126 [Document properties](#)  
T 1127 [File identification](#)  
T 1128 [External item identification assignment](#)  
T 1129 [External properties](#)  
T 1130 [Derived shape element](#)

T 1131 [Construction geometry](#)  
@ 1132 [Associative text](#)  
T 1133 [Single part representation](#)  
T 1134 [Product structure](#)  
O 1135 [Work management](#)  
T 1136 [Text appearance](#)  
O 1137 [Simplified cataloging](#)  
T 1140 [Requirement identification and version](#)

T 1141 [Requirement view definition](#)  
T 1142 [Requirement view definition relationship](#)  
T 1143 [Building component](#)  
T 1144 [Building item](#)  
T 1145 [Building structure](#)  
T 1146 [Location in building](#)  
T 1147 [Manufacturing configuration effectivity](#)

T 1151 [Functional data](#)  
X 1152 [Structure and classification](#)  
O 1153 [Plant system functional data and schematic representation](#)  
O 1154 [Plant system functional data](#)  
T 1156 [Product structure and classification](#)  
T 1157 [Class of product structure](#)  
T 1158 [Class of composition of product](#)

T 1159 [Class of connection of product](#)  
T 1160 [Class of containment of product](#)

T 1161 [Class of involvement of product in connection](#)  
T 1162 [Class of product library](#)  
T 1163 [Individual product structure](#)  
T 1164 [Product as individual](#)  
T 1165 [Involvement of individual product in connection](#)  
T 1166 [Composition of individual product](#)  
T 1167 [Connection of individual product](#)

**S AM Title**

O 1360 [Annotated presentation](#)

O 1361 [Associative Annotation](#)  
O 1362 [Dimension and tolerance callouts](#)  
T 1364 [Event assignment](#)  
T 1365 [Time interval assignment](#)  
D 1366 [Tagged text representation](#)  
O 1367 [Textual expression representation](#)  
O 1368 [Document order](#)  
O 1369 [Binary representation](#)  
O 1370 [Data structure representation](#)

O 1371 [State based behavior](#)

O 1433 [Project Management](#)  
O 1434 [Project management resource information](#)  
O 1435 [Organization structure](#)  
O 1436 [Project breakdown](#)  
O 1437 [Schedule](#)  
O 1438 [Work structure](#)  
O 1439 [Project management management resource information connector](#)  
O 1440 [Project management project management resource information connector](#)

O 1441 [Project management organization structure connector](#)  
O 1442 [Project management project breakdown connector](#)  
O 1443 [Project management schedule structure connector](#)  
O 1444 [Project management work structure connector](#)  
O 1445 [Information packet](#)  
O 1446 [System requirements](#)  
O 1447 [System requirements connector](#)  
O 1448 [System behavior](#)  
O 1449 [System behavior connector](#)  
O 1450 [System structure](#)

O 1451 [System structure connector](#)  
O 1452 [Requirement categorization](#)  
O 1453 [Function based behavior](#)  
O 1454 [Transformation input output](#)  
O 1455 [Transformation order](#)  
O 1456 [Order condition](#)  
O 1457 [Shared resource](#)  
O 1459 [Input output](#)  
O 1460 [Requirement model assignment](#)

O 1461 [System risk connector](#)  
O 1462 [Time duration relationship](#)  
O 1463 [Transformation](#)  
O 1464 [User defined attribute](#)  
O 1465 [Working draft system engineering](#)  
O 1466 [Program Management](#)  
O 1467 [Risk management](#)  
O 1468 [External state based behaviour model](#)  
O 1469 [Foundation state definition](#)  
O 1470 [Parameter value specification](#)

O 1471 [State based behaviour representation](#)  
O 1472 [General model parameter](#)

O 1473 [Description assignment](#)  
O 1474 [Analysis assignment](#)  
O 1475 [Analysis characterized](#)  
O 1476 [Analysis identification](#)  
O 1477 [System modelling](#)  
O 1478 [External functional model](#)  
O 1479 [Extended task element](#)  
O 1480 [Task element](#)

<p><b>S AM Title</b></p> <p>T 1168 <a href="#">Containment of individual product</a></p> <p>T 1169 <a href="#">Activity structure and classification</a></p> <p>T 1170 <a href="#">Class of activity structure</a></p> <p>T 1171 <a href="#">Class of composition of activity</a></p> <p>T 1172 <a href="#">Class of connection of activity</a></p> <p>T 1173 <a href="#">Class of involvement in activity</a></p> <p>T 1174 <a href="#">Class of activity library</a></p> <p>T 1175 <a href="#">Individual activity structure</a></p> <p>T 1176 <a href="#">Individual activity</a></p> <p>T 1177 <a href="#">Composition of individual activity</a></p> <p>T 1178 <a href="#">Connection of individual activity</a></p> <p>T 1179 <a href="#">Individual involvement in activity</a></p> <p>O 1180 <a href="#">Document structure and classification</a></p> <p>O 1181 <a href="#">Class of document library</a></p> <p>O 1182 <a href="#">Class of document</a></p> <p>O 1183 <a href="#">Class of composition of document</a></p> <p>O 1184 <a href="#">Document as realized</a></p> <p>O 1185 <a href="#">Composition of individual document</a></p> <p>O 1186 <a href="#">Person role and classification</a></p> <p>O 1187 <a href="#">Class of person library</a></p> <p>T 1188 <a href="#">Class of person</a></p> <p>O 1189 <a href="#">Class of role of person in organization</a></p> <p>O 1190 <a href="#">Person as realized</a></p> <p>O 1191 <a href="#">Role of individual person in organization</a></p> <p>O 1192 <a href="#">Organization structure and classification</a></p> <p>O 1193 <a href="#">Class of organization library</a></p> <p>O 1194 <a href="#">Class of organization</a></p> <p>O 1195 <a href="#">Class of composition of organization</a></p> <p>O 1196 <a href="#">Organization as realized</a></p> <p>O 1197 <a href="#">Composition of individual organization</a></p> <p>T 1198 <a href="#">Property and property assignment</a></p> <p>T 1199 <a href="#">Possession of property</a></p> <p>T 1203 <a href="#">Schematic and symbolization</a></p> <p>T 1204 <a href="#">Schematic drawing</a></p> <p>T 1205 <a href="#">Schematic element</a></p> <p>T 1206 <a href="#">Draughting annotation</a></p> <p>T 1207 <a href="#">Drawing structure and administration</a></p> <p>T 1208 <a href="#">Schematic element library</a></p> <p>T 1209 <a href="#">Symbolization by schematic element</a></p> <p>T 1210 <a href="#">Set theory</a></p> <p>T 1211 <a href="#">Cardinality of relationship</a></p> <p>T 1212 <a href="#">Classification</a></p> <p>T 1213 <a href="#">Reference data library</a></p> <p>T 1214 <a href="#">System breakdown</a></p> <p>T 1215 <a href="#">Physical breakdown</a></p> <p>T 1216 <a href="#">Functional breakdown</a></p> <p>T 1217 <a href="#">Zonal breakdown</a></p> <p>T 1218 <a href="#">Hybrid breakdown</a></p>	<p><b>S AM Title</b></p> <p>O 1481 <a href="#">Behaviour view definition</a></p> <p>O 1482 <a href="#">Behaviour identification and version</a></p> <p>O 1483 <a href="#">Behaviour description assignment</a></p> <p>O 1484 <a href="#">System identification and version</a></p> <p>O 1485 <a href="#">System view definition</a></p> <p>O 1486 <a href="#">Decision support</a></p> <p>O 1487 <a href="#">Trade study</a></p> <p>O 1488 <a href="#">Verification and validation</a></p> <p>O 1489 <a href="#">Issue management</a></p> <p>O 1490 <a href="#">Issue</a></p> <p>T 1501 <a href="#">Edge based wireframe</a></p> <p>T 1502 <a href="#">Shell based wireframe</a></p> <p>T 1507 <a href="#">Geometrically bounded surface</a></p> <p>T 1509 <a href="#">Manifold surface</a></p> <p>T 1510 <a href="#">Geometrically bounded wireframe</a></p> <p>T 1511 <a href="#">Topologically bounded surface</a></p> <p>T 1512 <a href="#">Faceted boundary representation</a></p> <p>T 1514 <a href="#">Advanced boundary representation</a></p>
<p><b>STEP AP210 Modules</b></p> <p><b>S AM Title</b></p> <p>D 1601 <a href="#">Altered package</a></p> <p>D 1602 <a href="#">Altered part</a></p> <p>D 1603 <a href="#">Analytical model</a></p> <p>D 1604 <a href="#">AP210 assembly functional interface requirements</a></p> <p>D 1605 <a href="#">AP210 assembly functional requirements</a></p> <p>D 1606 <a href="#">AP210 assembly physical design</a></p> <p>D 1607 <a href="#">AP210 assembly physical interface requirements</a></p> <p>D 1608 <a href="#">AP210 assembly physical requirements</a></p> <p>D 1609 <a href="#">AP210 assembly requirement allocation</a></p> <p>D 1610 <a href="#">AP210 assembly technology constraints</a></p>	<p><b>STEP AP210 Modules</b></p> <p><b>S AM Title</b></p> <p>D 1691 <a href="#">Interface component</a></p> <p>D 1692 <a href="#">Land</a></p> <p>D 1693 <a href="#">Layered 2d shape</a></p> <p>D 1694 <a href="#">Layered 3d shape</a></p> <p>D 1695 <a href="#">Layered interconnect module 2d design</a></p> <p>D 1696 <a href="#">Layered interconnect module 3d design</a></p> <p>D 1697 <a href="#">Layered interconnect module 3d shape</a></p> <p>D 1698 <a href="#">Layered interconnect module design</a></p> <p>D 1699 <a href="#">Layered interconnect module design with design intent modifications</a></p> <p>D 1700 <a href="#">Layered interconnect module with printed component</a></p>



D 1611 [AP210 connection zone based model extraction](#)  
 D 1612 [AP210 device functional and physical characterization](#)  
 D 1613 [Physical unit non planar design view](#)  
 D 1614 [AP210 functional decomposition](#)  
 D 1615 [AP210 functional requirement allocation](#)  
 D 1616 [AP210 functional specification](#)  
 D 1617 [AP210 interconnect design](#)  
 D 1618 [AP210 interconnect design for microwave](#)  
 D 1619 [AP210 interconnect functional requirements](#)  
 D 1620 [AP210 interconnect physical requirements](#)  
  
 D 1621 [AP210 interconnect requirement allocation](#)  
 D 1622 [AP210 interconnect technology constraints](#)  
 D 1623 [AP210 laminate assembly design](#)  
 D 1624 [AP210 package functional and physical characterization](#)  
 D 1625 [AP210 packaged part white box model](#)  
 D 1626 [AP210 physical unit physical characterization](#)  
 D 1627 [AP210 printed part functional and physical characterization](#)  
 D 1628 [AP210 product data management](#)  
 D 1629 [AP210 product requirement allocation](#)  
 D 1630 [AP210 product rule](#)  
  
 D 1631 [Area 2d](#)  
 D 1632 [Assembly 2d shape](#)  
 D 1633 [Assembly 3d shape](#)  
 D 1634 [Assembly component placement requirements](#)  
 D 1635 [Assembly functional interface requirement](#)  
 D 1636 [Assembly module design](#)  
 D 1637 [Assembly module macro definition](#)  
 D 1638 [Assembly module with cable component 2d](#)  
 D 1639 [Assembly module with cable component 3d](#)  
 D 1640 [Assembly module with macro component](#)  
  
 D 1641 [Assembly module with subassembly](#)  
 D 1642 [Assembly module usage view](#)  
 D 1643 [Assembly module with interconnect component](#)  
 D 1644 [Assembly module with cable component](#)  
 D 1645 [Assembly module with packaged connector component](#)  
 D 1646 [Assembly shape](#)  
 D 1647 [Assembly physical interface requirement](#)  
 D 1648 [Assembly physical requirement allocation](#)  
 D 1649 [Assembly technology](#)  
 D 1650 [Bare die](#)  
  
 D 1651 [Basic curve](#)  
 D 1652 [Basic geometry](#)  
 D 1653 [Cable](#)  
 D 1654 [Characteristic](#)  
 D 1655 [Chemical substance](#)  
 D 1656 [Component grouping](#)  
 D 1657 [Component feature](#)  
 D 1658 [Connectivity allocation to physical network](#)  
 D 1659 [Curve swept solid](#)  
 D 1660 [Datum difference based mode](#)  
  
 D 1661 [Design management](#)  
 D 1662 [Design specific assignment to assembly usage view](#)  
 D 1663 [Design specific assignment to interconnect usage](#)

[design](#)  
 D 1701 [Layout macro definition](#)  
 D 1702 [Manifold subsurface](#)  
 D 1703 [Model parameter](#)  
 D 1704 [Network functional design view](#)  
 D 1705 [Functional usage view](#)  
 D 1706 [Non feature shape element](#)  
 D 1707 [Package](#)  
 D 1708 [Packaged connector model](#)  
 D 1709 [Packaged part white box model](#)  
 D 1710 [Packaged part black box model](#)  
  
 D 1711 [Part external reference](#)  
 D 1712 [Part feature function](#)  
 D 1713 [Part feature grouping](#)  
 D 1714 [Part feature location](#)  
 D 1715 [Part occurrence](#)  
 D 1716 [Part template 2d shape](#)  
 D 1717 [Part template 3d shape](#)  
 D 1718 [Part template extension](#)  
 D 1719 [Part template non planar shape](#)  
 D 1720 [Part template shape with parameters](#)  
  
 D 1721 [Physical component feature](#)  
 D 1722 [Physical layout template](#)  
 D 1723 [Physical node requirement to implementing component allocation](#)  
 D 1724 [Physical unit 2d design view](#)  
 D 1725 [Physical unit 3d design view](#)  
 D 1726 [Physical unit 2d shape](#)  
 D 1727 [Physical unit 3d shape](#)  
 D 1728 [Physical unit design view](#)  
 D 1729 [Physical unit interconnect definition](#)  
 D 1730 [Physical unit shape with parameters](#)  
  
 D 1731 [Constructive solid geometry 2d](#)  
 D 1732 [Physical unit usage view](#)  
 D 1733 [Planned characteristic](#)  
 D 1734 [Pre defined datum symbol](#)  
 D 1735 [Pre defined datum 2d symbol](#)  
 D 1736 [Pre defined datum 3d symbol](#)  
 D 1737 [Printed physical layout template](#)  
 D 1738 [Product identification extension](#)  
 D 1739 [Production rule](#)  
 D 1740 [Requirement decomposition](#)  
  
 D 1741 [Sequential laminate assembly design](#)  
 D 1742 [Shape composition](#)  
 D 1743 [Shape parameters](#)  
 D 1744 [Shield](#)  
 D 1745 [Signal](#)  
 D 1746 [Software](#)  
 D 1747 [Specification document](#)  
 D 1748 [Stratum non planar shape](#)  
 D 1749 [Styled curve](#)  
 D 1750 [Text representation](#)  
  
 D 1751 [Test requirement allocation](#)  
 D 1752 [Thermal network definition](#)  
 D 1753 [Value with unit extension](#)  
 D 1754 [Via component](#)  
 D 1755 [Physical connectivity definition](#)

[view](#)

D 1664 [Device marking](#)

D 1665 [Electrical network definition](#)

D 1666 [Extended geometric tolerance](#)

D 1667 [Extended elemental geometric shape](#)

D 1668 [Fabrication joint](#)

D 1669 [Fabrication requirement](#)

D 1670 [Fabrication technology](#)

D 1671 [Feature and connection zone](#)

D 1672 [Fill area style](#)

D 1673 [Edge shape feature](#)

D 1674 [Functional assignment to part](#)

D 1675 [Functional decomposition to assembly design](#)

D 1676 [Functional decomposition to design](#)

D 1677 [Functional decomposition to interconnect design](#)

D 1678 [Functional decomposition with nodal representation to packaged mapping](#)

D 1679 [Functional specification](#)

D 1680 [Functional unit requirement allocation](#)

D 1681 [Generic material aspects](#)

D 1682 [Interconnect 2d shape](#)

D 1683 [Interconnect 3d shape](#)

D 1684 [Interconnect module connection routing](#)

D 1685 [Interconnect module to assembly module relationship](#)

D 1686 [Interconnect module usage view](#)

D 1687 [Interconnect module with macros](#)

D 1688 [Interconnect non planar shape](#)

D 1689 [Interconnect physical requirement allocation](#)

D 1690 [Interconnect placement requirements](#)

D 1756 [Conductivity material aspects](#)

D 1757 [Test select product](#)

D 1758 [Promissory usage in product concept](#)

D 1759 [Ap210 datum difference based model definition](#)

D 1760 [Pre defined product data management specializations](#)

O 1761 [Information product](#)

O 1762 [Generic product occurrence](#)

O 1763 [Integral shield](#)

O 1764 [Shape feature](#)

O 1765 [Characterizable object](#)

**Legend: TS Status**

0-10 =O=prop-->apvl for ballot

10-20=A=NP blt circ-->NP apvl

20-60=D=DTS dev-->reg as TS

@ At ISO, approved for publication

>60 =T=TS Published

98 =X= Project withdrawn

jgnell, 1989-Oct.-23; rev. 2002-Nov-08. Origin: ISO 10303 Editing Committee. On-line: <http://www.nist.gov/sc5/soap/>

**Chg 1. 2004-06-20/jpbrazy** Reverse engineered SOAP to MS Word source to enable linking to SC4ONLINE Project folders.

**Chg 2. 2006-05-05/jpbrazy** - Updated Status through 2006-03-31

## **10.4 APPENDIX D – Scopes for ISO 14649 Parts**

### **ISO 14649 – Data Model for Computerized Numerical Control (CNC)**

(ISO 14649 Parts are being developed in ISO TC184/SC1)

#### **ISO/DIS 14649-1 Overview and fundamental principles**

Data model for computerized numerical controllers. Overview and fundamental principles.

#### **ISO/DIS 14649-10 General process data**

This part of ISO 14649 specifies the process data which is generally needed for NC-programming within all machining technologies. These data elements describe the interface between a computerised numerical controller and the programming system (i.e. CAM system or shopfloor programming system). On the programming system, the programme for the numerical controller is created. This programme includes geometric and technological information. It can be described using this part of ISO 14649 together with the technology-specific parts (ISO 14649-11, etc.). This part of ISO 14649 provides the control structures for the sequence of programme execution, mainly the sequence of working steps and associated machine functions.

The “machining\_schema” defined in this part of ISO 14649 contains the definition of data types which are generally relevant for different technologies (e.g. milling, turning, grinding). The features for non-milling technologies like turning, EDM, etc. will be introduced when the technology specific parts like ISO 14649-12 for turning, ISO 14649-13 for EDM, and ISO 14649-14 for contour cutting of wood and glass are published. It includes the definition of the workpiece, a feature catalogue containing features which might be referenced by several technologies, the general executables and the basis for an operation definition. Not included in this schema are geometric items and representations, which are referenced from ISO 10303’s generic resources, and the technology-specific definitions, which are defined in separate parts of ISO 14649.

This part of ISO 14649 cannot stand alone. An implementation needs in addition at least one technology-specific part (e.g. ISO 14649-11 for milling, ISO 14649-12 for turning).

Additionally, the schema uses machining features similar to ISO 10303-224 and ISO 10303-214. The description of process data is done using the EXPRESS language as defined in ISO 10303 11. The encoding of the data is done using ISO 10303-21.

#### **ISO/DIS 14649-11 - Process data for milling**

The purpose of ISO 14649 - 11 is to:

- ◆ Re-establish an accepted standard for the transmission of NC data to the shop floor!
- ◆ Provide motion control data based on splines for sophisticated, high-speed NC cutting operations
- ◆ Avoid intermediate data formats (CLDATA)
- ◆ Provide all necessary data for easy modification of NC data at the machine controller
- ◆ Replaces the old “M and G” codes with “working steps”

This part of ISO14649 specifies the data elements needed as process data for milling

This part of ISO 14649 specifies the technology-specific data elements needed as process data for milling.

Together with the general process data described in ISO 14649-10, it describes the interface between a computerized numerical controller and the programming system (i.e. CAM system or shopfloor programming system) for milling . It can be used for milling operations on all types of machines, be it milling machines, machining centers, or lathes with motorized tools capable of milling. The scope of this part does not include any other technologies, like turning, grinding, or EDM. These technologies will be described in further parts of ISO 14649.

Subject of the milling\_schema, which is described in this part of ISO 14649, is the definition of technology-specific data types representing the machining process for milling and drilling. This includes both milling of freeform surfaces as well as milling of prismatic workpieces (also known as 2½D-milling). Not included in this schema are geometric items, representations, manufacturing features, executable objects, and base classes which are common for all technologies. They are referenced from ISO 10303's generic resources and ISO 14649-10. The description of process data is done using the EXPRESS language as defined in ISO 10303-11. The encoding of the data is done using ISO 10303-21.

**OUT OF SCOPE:**

- turning
- grinding
- EDM

The scope of this part of ISO 14649 does not include tools for any other technologies, like turning, grinding, or EDM. Tools for these technologies will be described in further parts of ISO 14649.

**ISO/NWI 14649-12 Process data for turning**

(The scope of this part will be analogous to Part 11, except that it will address turned parts.)

**ISO/DIS 14649-111 Tools for milling**

This part of ISO 14649 specifies the data elements needed as tools for milling. They work together with ISO 14649- 11, the process data for milling. These data elements can be used as a criteria to select one of several milling and drilling type tools, not to describe a complete information of a particular tool. Therefore, leaving out optional attributes gives the controller more freedom to select from a larger set of tools. The NC is assumed to have access to complete description of specific tools in a database.

The milling\_tool\_schema defined in this part of ISO 14649 serves as a basic tool schema including just the most important information. It is intended to give the controller enough information to select the tool specified in the NC program.

In ISO 6983, the tool is defined just with its number (e.g. T8). No further information concerning the tool type or geometry is given. This information is part of the tool set-up sheet, which is supplied with the NC-program to the machine. The tool set-up sheet gives the relationship between the tool location (e.g. slot 8) and the type of tool (e.g. "drill 4 mm").

The approach of this tool sheet to ISO 14649-11 is to include the information which is contained in the tool set-up sheet mentioned above in the NC program. Therefore, the most important information which needs to be included in the tool description is:

- . tool type
- . tool geometry
- . expected tool life

The tool schema does not include information which is part of the tool database. The tool database is related to the machine and the tools themselves but independent of the NC program. This means that data like the following data types are not included in the tool schema:

- normative tool life
- tool location in the tool changer

The tool schema does not include information about tool holders and tool assembly components.

It is important to understand that all length measure types used in this Part are not toleranced length measure types because they are used to describe the tools **required** for the manufacturing of a workpiece, not the actual dimensions of the tools available at the machine. A real tool must be selected by the tool management based on the actual tool dimensions and the tolerances of features.

The overall structure of the tool description in this part of ISO 14649 and ISO 14649-10 is the same with ISO/DIS 13399-1. Many definitions of tool body and it's geometry are referenced from the NIST tool model. [NISTIR5707:Modeling of Manufacturing Resource Information, July,1995]

#### **OUT OF SCOPE**

The scope of this part of ISO 14649 does not include tools for any other technologies, like turning, grinding, or EDM. Tools for these technologies will be described in further parts of ISO 14649.

#### **ISO/NWI 14649-112 Tools for turning**

(The scope of this part will be analogous to Part 111, except that it will address turned parts.)