

Kuchenzeichnung

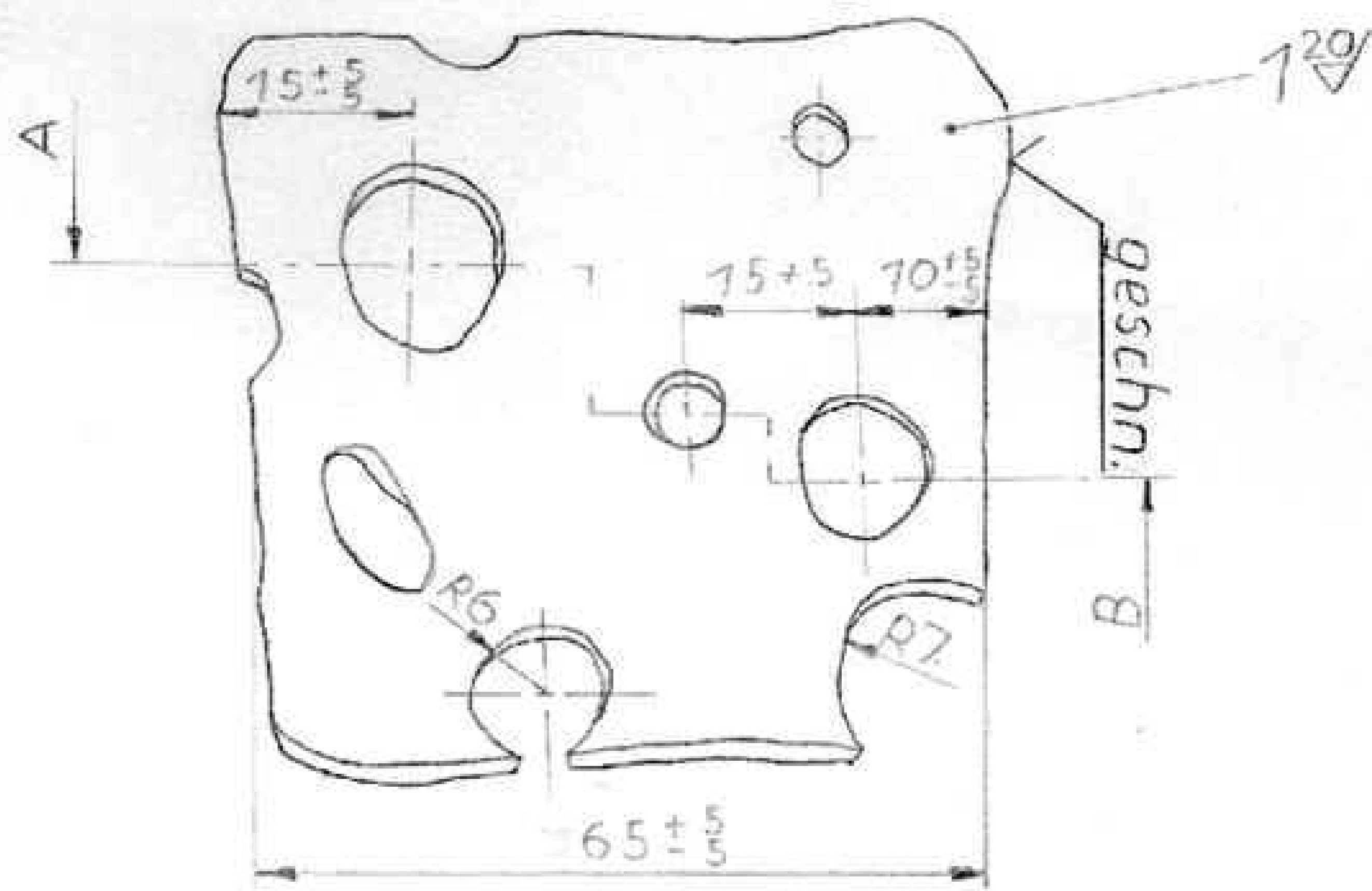

Aufschnitt A-B

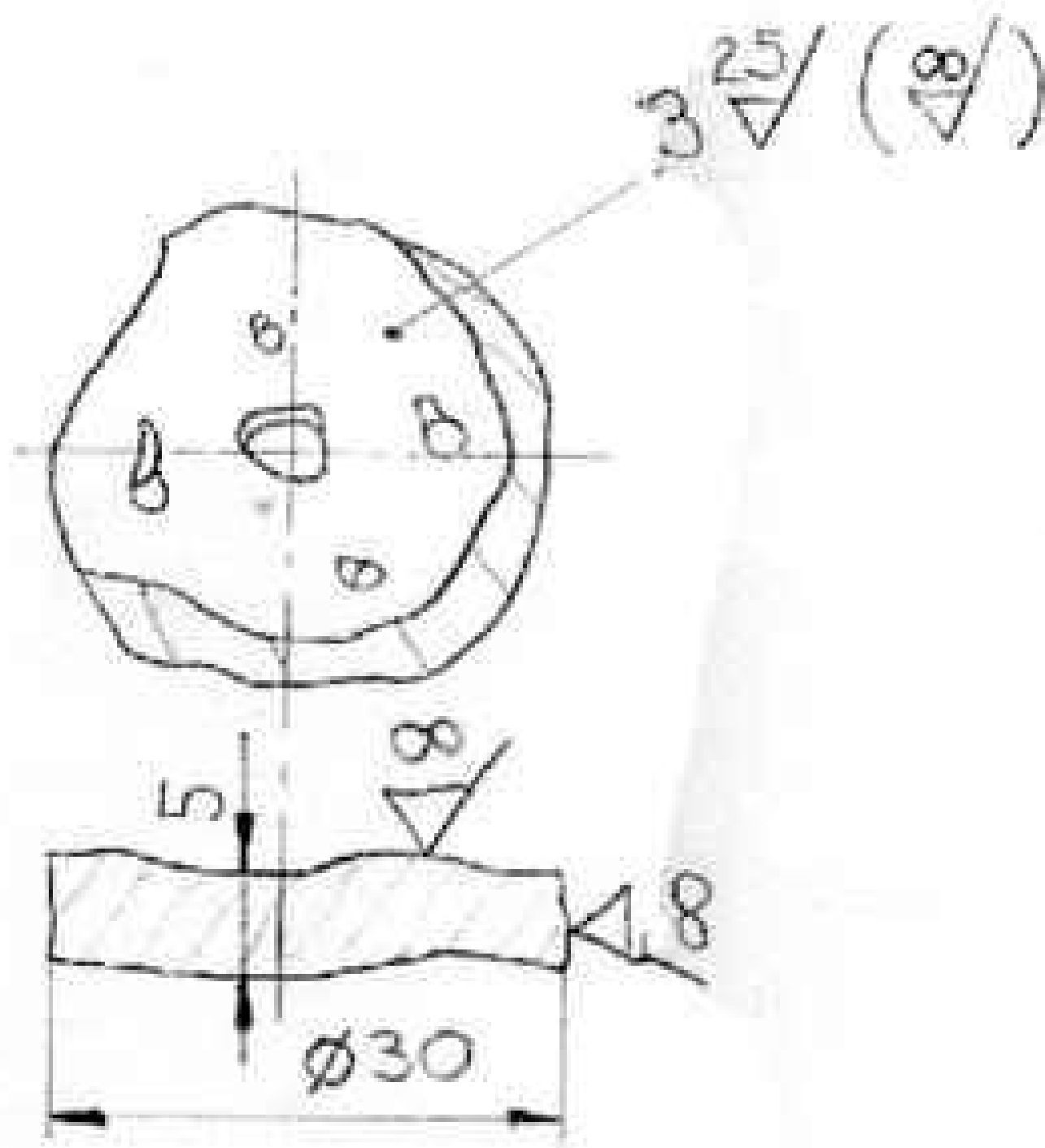
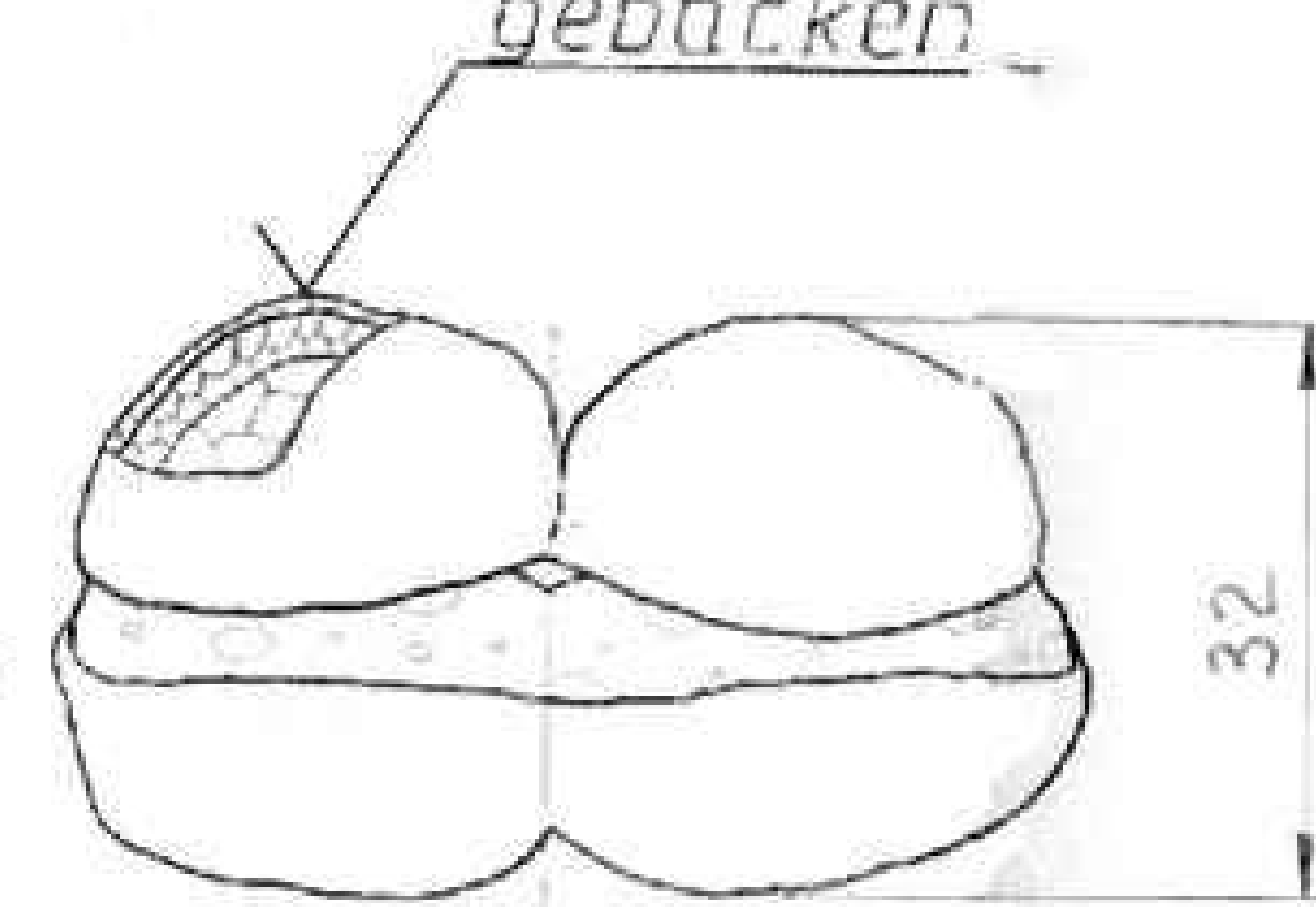
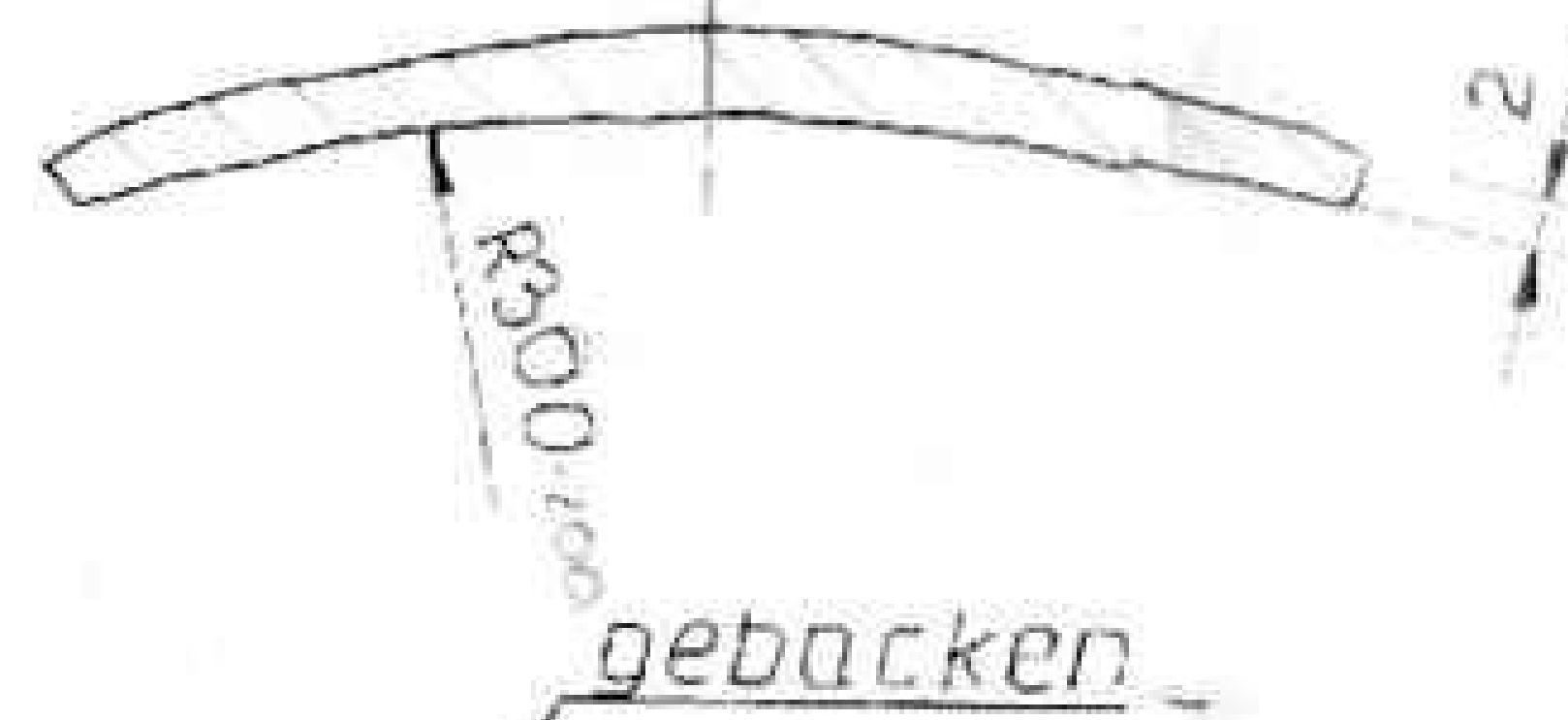
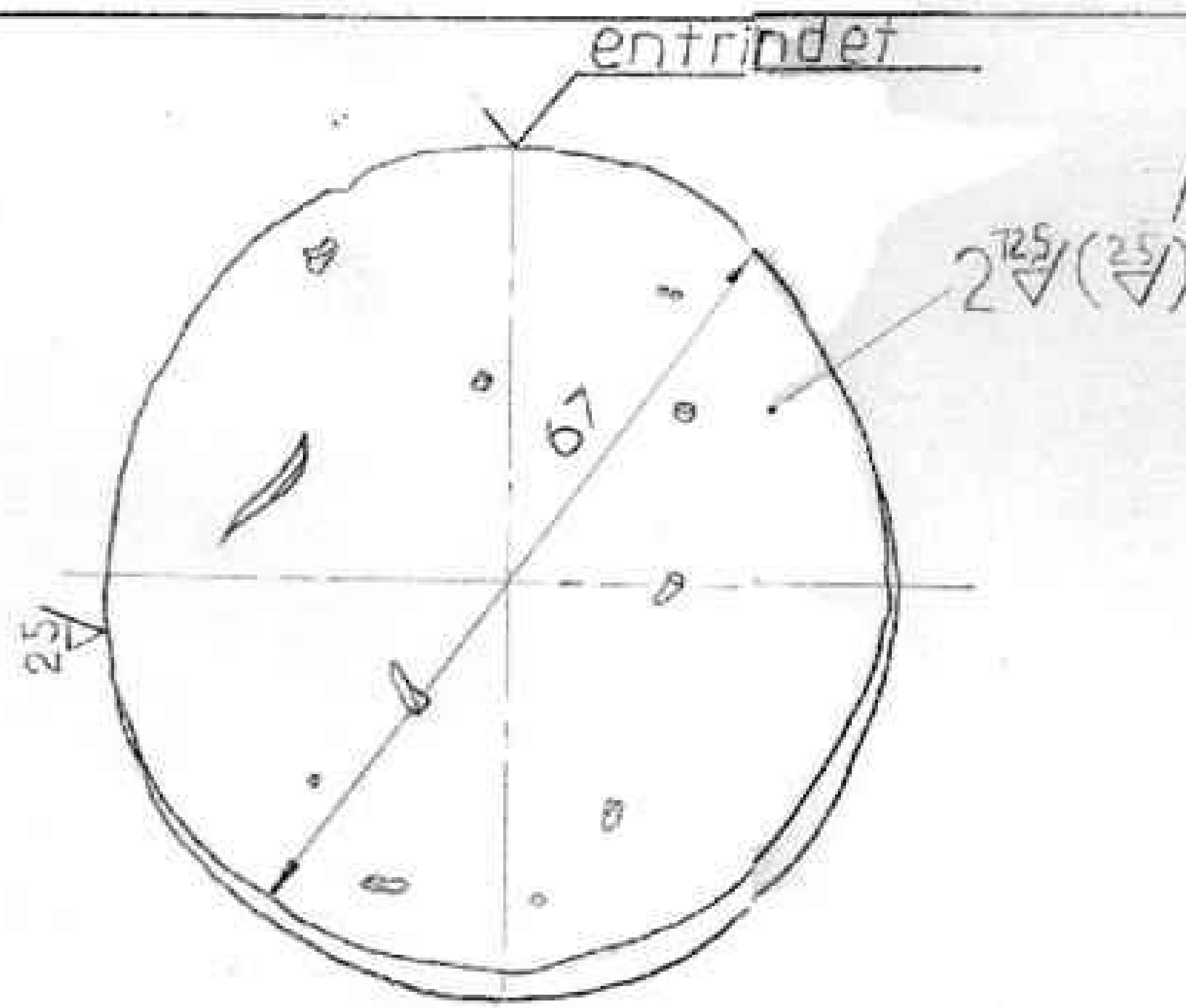
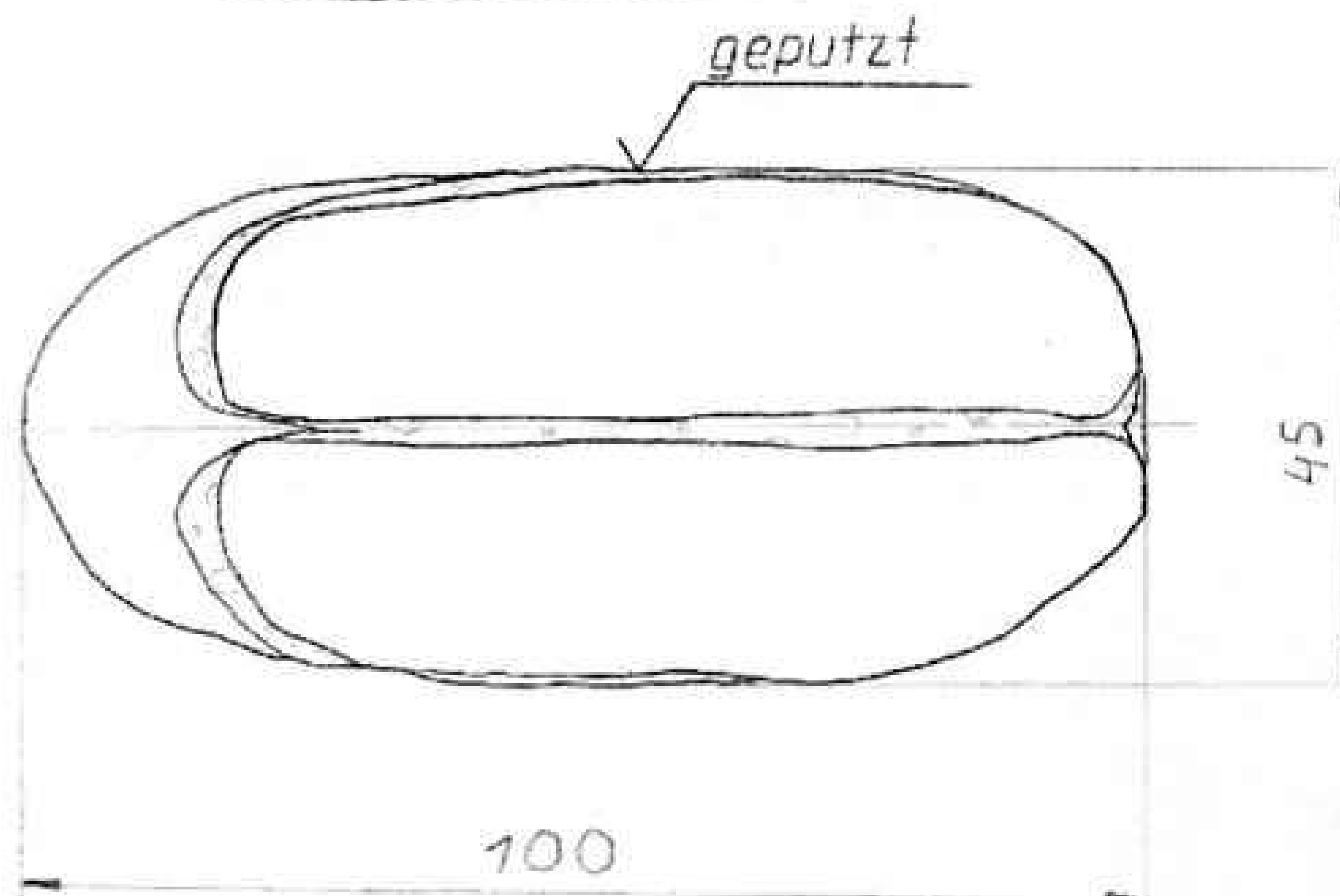
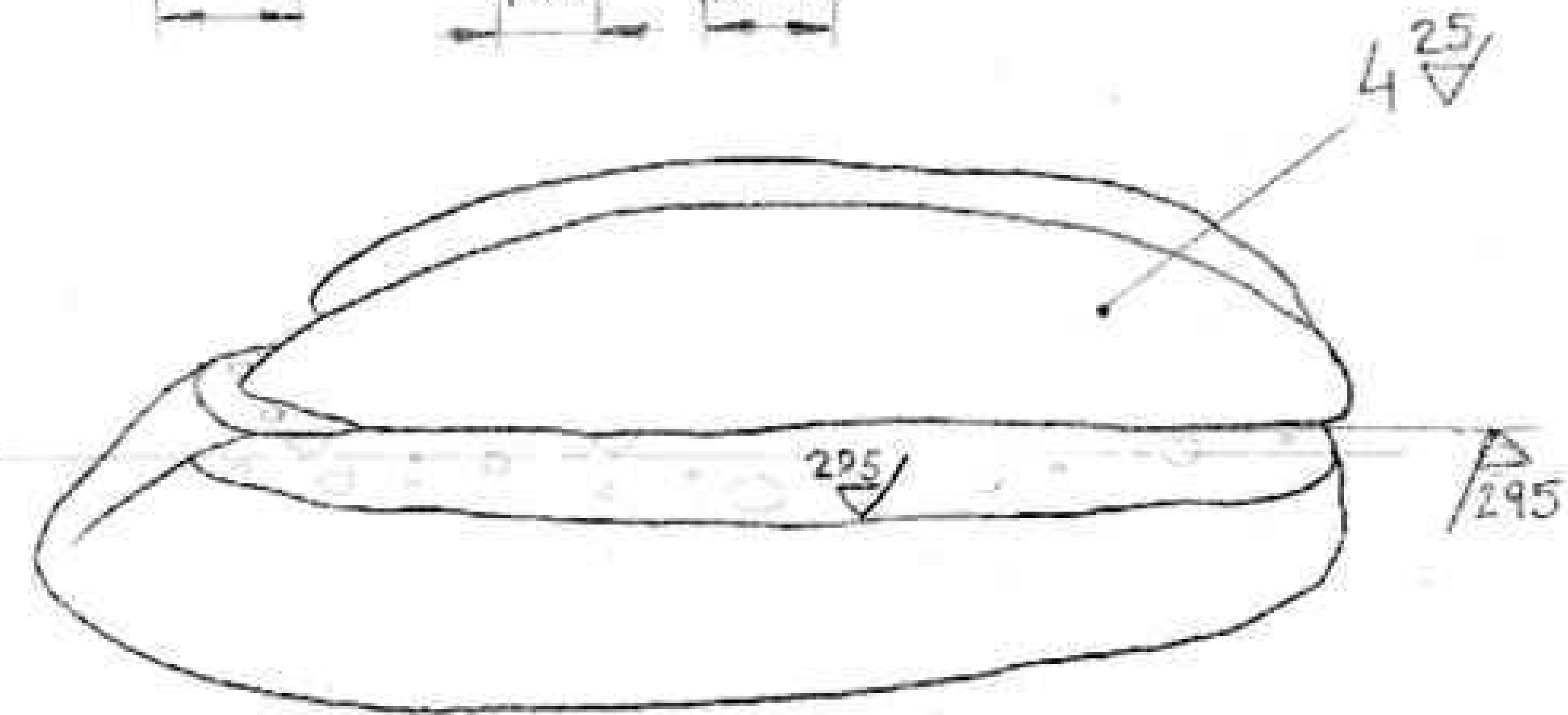

Menüzeichnung

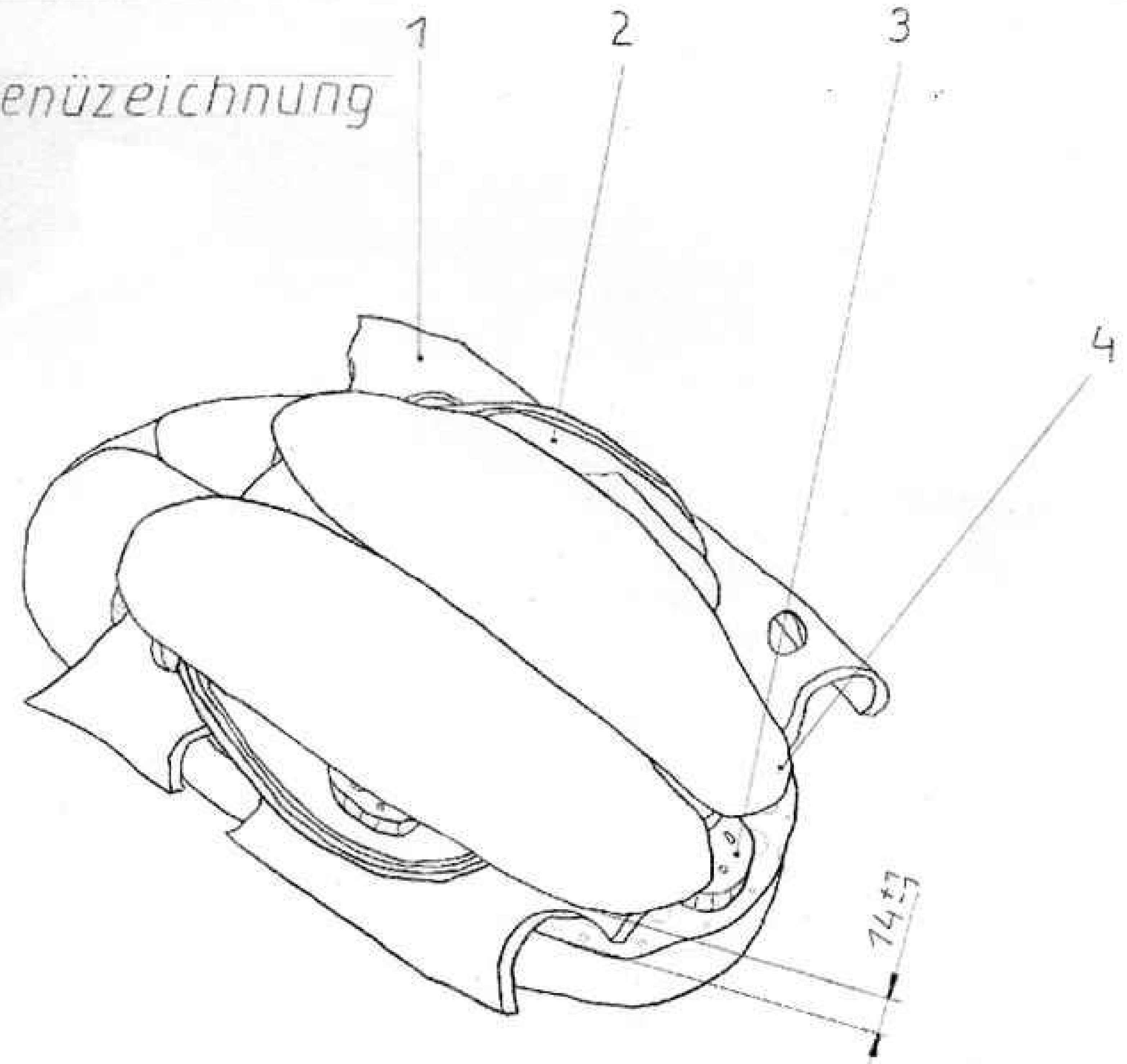

Schnittfl. d. Semmel mit Teebutter geschmiert

Stk	Benennung	Teil	Norm	WSt.	Bemerkungen
1	Semmel	4	Bock-N 1 Teil		ADEG-Sonderang
3	Gurke	3	Nat. N 53 Organisch		Garten gedung
3	Extrawurst (Pikant)	2	Fleisch 4 Augen		Affe, blind-Lebend
1	Emmentaler	1	Kuh-N 34 Milch		weiß 40% Fett

Tag	Spitzname	Husch, Pflusch	VERTICAL WISDOM	Murx & CO	Die Harte Böhle Argh
Gez. 99.990	Martin Vidric				
Gepr.					
N. Gepr.					
Maßst.					
1:1					
Geschmacks- tol. exquis.					

Pass.	Größtm	Kleinst.
$\phi 11H5$	$\phi 11,008$	$\phi 11,000$
$\phi 7H5$	$\phi 7,006$	$\phi 7,000$
$\phi 10H10$	$\phi 10,058$	$\phi 10,000$

Letztes Progr. WSKU  
Rezept 1  
Klasse 2M ORIGINAL