



EPLAN Data Standard

(English version)



Issue: October 2021

Based on EPLAN Version 2.9 SP1

PROCESS CONSULTING

ENGINEERING SOFTWARE

IMPLEMENTATION

GLOBAL SUPPORT

Explanation for manufacturers

Since 2008, the EPLAN Data Portal has made component data from many manufacturers available in EPLAN format. When EPLAN Electric P8 was launched on the market, the basic idea was to provide the electrical macros for the individual components in order to reduce the effort involved in creating circuit diagrams with EPLAN Electric P8. Today, engineers use the EPLAN portfolio for more processes than just creating circuit diagrams. In particular, the modern switch cabinet production demands the requirements on component data. Detailed data such as 3D files, connection diagrams and drilling patterns are required for modern production processes. In addition, users of the EPLAN software want to carry out efficient engineering and automate recurring workflows. The EPLAN software can support these processes, but for this purpose customers require standardized data from different manufacturers.

In view of this situation, EPLAN is developing the EPLAN Data Standard for the Data Portal. It describes which data is to be provided in which form in the Data Portal. Components that meet the EPLAN Data Standard are easier to integrate into the planning and production process of EPLAN users, hence saving time and being cost effective..

Explanation for users

The EPLAN Data Portal has grown very successfully since 2008. Over 950,000 component data in EPLAN format from over 304 manufacturers can be found here. At the same time, the importance of component data in engineering and manufacturing processes has also increased. Enclosures are planned in 3D and mounting plates are processed automatically by machines. As a result, many new requirements for component data are being imposed on manufacturers.

EPLAN is developing the EPLAN Data Standard to channel these requirements and provide both manufacturers and users with a basis for creating and using component data. It describes which data fields can expect a user when downloading components from the Data Portal.

This should reduce the maintenance effort for article data at the user and increase the manageability of the data for automated processes.



The EPLAN Data Standard is not a seal of approval for the correctness of the content of the data. Contents are provided by the manufacturers with great care. Every user feedback contributes to further improving data quality.

Notes on the readability of the EPLAN Data Standard document

The following document describes the requirements for component data. The headings are based on the properties of EPLAN parts management. Headings marked with the EPLAN Data Standard logo () are mandatory fields in the standard and must be filled in. However, these may vary from product subgroup to product subgroup. **The exact definition of the individual properties of the respective product subgroups can be found in the supplementary document "EPLAN_Data_Standard_Product_group_overview_EN".**

Data records that comply with the EPLAN Data Standard are marked with the logo in the EPLAN Data Portal and thus are immediately recognized by the user.

Index

Changelog.....	5
General definitions	7
Creation of macros – General rules	12
Record type: Manufacturer / Supplier	13
Record type: Part	15
Record type: Drilling pattern 	29
Record type: Connection point pattern 	30
Record type: Accessory placement	42
Record type: Accessory list	43
Specific data fields for Terminals.....	44
Specific data fields for Cables	54
Specific data fields for Relays, contactors	60
Specific data fields for Protection devices.....	65
Specific data fields for Connections.....	68
Specific data fields for Plugs.....	72
Specific data fields for Enclosure.....	77
Specific data fields for Cable ducts.....	80
Specific data fields for PLC.....	83
Specific data fields for Fluid Power.....	95
Specific data fields for Housing	101
Specific data fields for Housing accessories, internal extension	103
Specific data fields for Busbars	105
Specific data fields for Routing accessories.....	107
Specific data fields for User-defined rail.....	108

Changelog

Chapter	Change
General definitions > Multilingual fields	Definition is changed for Language-neutral language identifier (??_??)
General definitions > Length-variable items	New chapter
Creation of macros – General rules	Settings tab in the Macro box dialog is described
Record type: Part > Tab: General	More detailed description for the Designation 1 property
Record type: Part > Tab: User-defined properties	More detailed description
Record type: Part > Tab: Free properties	More detailed description
Record type: Part > Tab: Mounting data	More detailed description for the Graphical macro field
Record type: Part > Tab: Assembly	New chapter
Record type: Part > Tab: Accessories	More detailed description
Record type: Part > Tab: Documents	Definition is changed
Record type: Accessory list	New chapter
Specific data fields for Terminals	More detailed description
Specific data fields for Cables	Note for Prefabricated cables
Specific data fields for Mounting rail	This chapter is removed and definitions for Mounting rail are provided in the chapter Specific data fields for Housing accessories, internal extension
PLC – How to do	More detailed description
Specific Data fields for Fluid	More detailed description Added exception for sub-plats (max.working pressure)
Specific data fields for Housing	New chapter
Specific data fields for Housing accessories, internal extension	New chapter
Specific data fields for Busbars	New chapter
Specific data fields for Routing accessories	New chapter
Specific data fields for User-defined rail	New chapter
Excel sheet (new tabs): Product group overview	EPLAN Auxiliary Part MECHANICS_General 19-inch module technology Housing Housing accessories, external Housing accessories, internal Busbars Hook-up Lock systems Routing accessories User-defined rail FLUID_Filters FLUID_Fluid control terminal FLUID_Power units and plants FLUID_Pumps

	FLUID_Sensors FLUID_PNE_Sub-plates FLUID_HYD_Sub-plates FLUID_General FLUID_Accessories
Excel sheet (modified tabs): Product group overview	Terminals Cables Connections Relays, contactors Protection devices Plugs PLC Cable ducts FLUID_Actuators, general FLUID_Valves FLUID_Connections

Note:

With this document, all previous documents of the EPLAN Data Standard are obsolete and only the information provided here is valid if it differs from the previous version.



General definitions

Formatting

In the case of textual information, attention must be paid to the typical uppercase and lowercase languages of the respective national language. Only upper or lowercase letters are not allowed. Exceptions are the specification of proper names (EPLAN, ALPHA, etc.)

Multilingual fields





Multilingual fields in EPLAN software are identified by one of the following icons.

	 The field is empty, or the contents of the field are language-neutral (this means that the language identifier “??_??” is used)
	 The contents of the field are language-dependent.

In the case of multilingual fields, at least the specification of the English (USA) language in the language identifier “en_US” is mandatory. Further languages can be added optionally. Make sure that the corresponding languages are also filled in each multilingual property that is used.

Exceptions are articles which are exclusively intended for a certain market and are only available there (e.g. China), in that case the corresponding language is adequate.

Care must be taken to include the corresponding language in the respective language identifier. A language other than the corresponding language identifier is not permitted.





	 de_DE → German text
	 en_US → English text
	 fr_FR → English text





The language identifier “??_??” must be used only if the contents of the field are entirely marked as excluded from translation and if the contents are partially marked as excluded from translation, language “en_US” must be used and further languages can be used.

If the contents of the field are entirely marked as excluded from translation, make sure that the translation is removed from the other language identifiers (use the “Remove translations” popup menu item in EPLAN).

When editing a multilingual field you can mark the highlighted text as excluded from translation in EPLAN software via the popup menu item (*Mark text as ‘Excluded from translation’*) or simply by typing the text between double braces `{{<text>}}`.

Please note that only language-neutral texts (non-translatable texts) must be marked as excluded from translation. If there is a text which is translatable, it must not be marked (see the below examples for describing a cable).

	  ??_??@{{PUR 4X0.34mm ² }}
	  ??_??@Control Cable {{PUR 4X0.34mm ² }}

  ??_??@{{Control Cable PUR 4X0.34mm²}}
  en_US@Control Cable {{PUR 4X0.34mm²}}

Path specifications: creation of the folder structure and file names / references

If references to files are specified (e.g. for documentations, macros or images), a fixed path (C:\folder\...) is not permitted. You must pay attention to use the path variable, like e.g. \$(MD_MACROS). In addition, the respective manufacturer-related subfolder structure must be defined with the full name from the settings on the tab page: set in Manufacturer / Supplier (e.g. \$(MD_MACROS)\<Manufacturer:Full Name>\...)

A total length of 240 characters must not be exceeded.

Generally, the nomenclature of file names and references (connection point patterns, drilling patterns, etc.) is not explicitly required. However, these should be plain text name used in the English language.

Specification of physical quantities

The specification of physical quantities is carried out according to standard EN ISO 80000-1 and DIN 1301-1. This means that the unit character follows the numeric value after a distance, usually the space. Exceptions are the following unit signs, which immediately follow the numerical value: °, ', "(Angle units such as degrees, minutes, seconds, etc.). Unit characters, which also contain a degree character (e.g. °C), are indicated by spaces.

Physical quantities are always indicated with a unit.

Make sure that there is no line break between number and unit.



10 V
 10-100 kV
 300/500 V
 0,5 mA
 5°
 20 °C
 G 1/4"
 G 2 1/2"

Length-variable items

Definitions in this chapter only apply to the following Product groups and subgroups from the "Mechanics" Generic product group but not for parts with length specifications (for example cables, connections, lines / conduits, hoses).

Product group	Product subgroup
Busbars	Busbar cover
	Rail
Cable ducts	General
	General
Housing accessories, internal extension	C horizontal rails
	Cable clamp rails
	Mounting rail
User-defined rail	General

A length-variable item in EPLAN only refers to the items from the above product subgroups that can be cut into several lengths such as Mounting rails, Busbar rails, Cable ducts, etc.

For the purpose of placing length-variable items in the 3D mounting layout properly, you should pay attention to the following properties in the EPLAN Parts management.

Delivery length <22058>

Enter the value of the delivery length in this field. Depending on the Product group and Product subgroup, this property can be found in the Properties tab.

If the value is empty or '0.00' we consider that the item is not a length-variable item (see below example).

For example, the following cable clamp rail is not defined as a length-variable item in EPLAN, because for this item, length can be changed mechanically by sliding the rail in or out, not by cutting into individual pieces. Therefore, the "Delivery length" property must not be filled.

[Rittal Cable Clamp C rail \(DK 7016.140\)](#)



The following properties can be found in the Mounting data tab.

Weight <22046>

For length-variable items this field must not be filled.

Dimensions

You must provide an outline extrusion (.fc2) in the Graphical macro field for any length-variable item. Exceptions are Cable ducts, Busbar rails, and Mounting rails for which the dimension fields can be used as described below, instead of an outline extrusion. EPLAN Pro Panel uses the dimension values to shape a standard form of these items in the 3D mounting layout.

Cable ducts

Generic product group:	Mechanics
Product group:	Cable ducts
Product subgroup:	General

Width <22013> and Depth <22014> must be filled, but Height <22012> must not be filled.

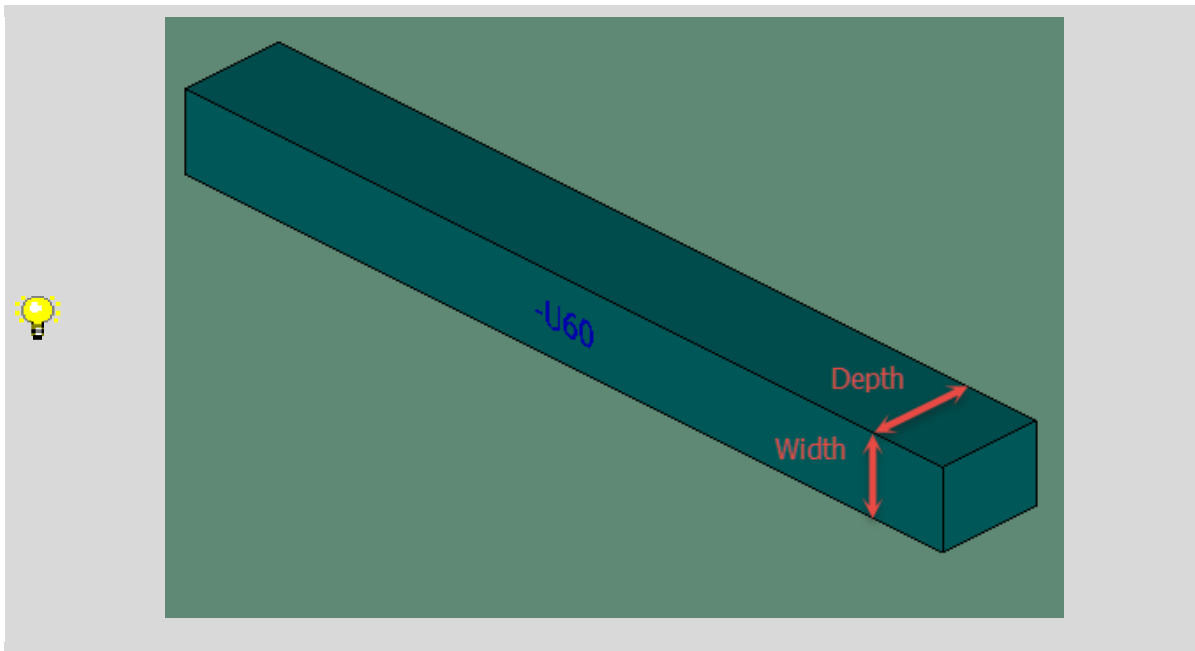

Busbar rails

Generic product group:	Mechanics
Product group:	Busbars
Product subgroup:	Rail

Width <22013> and Depth <22014> must be filled, but Height <22012> must not be filled.

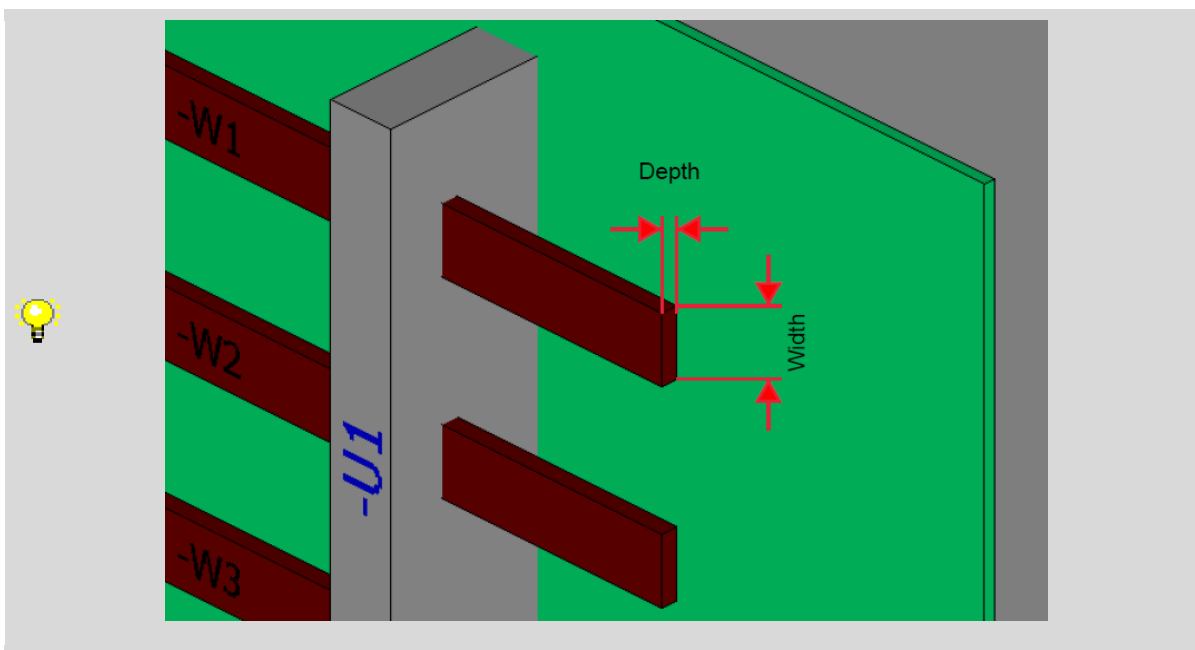

Mounting rails

Generic product group:	Mechanics
Product group:	Housing accessories, internal extension
Product subgroup:	Mounting rail

Height <22012>, Width top <22198> and Width bottom <22199> must be filled, but Width <22013> and Depth <22014> must not be filled.

Width top <22198> and Width bottom <22199> properties are available only for Mounting rail product subgroup and can be found in the Properties tab.

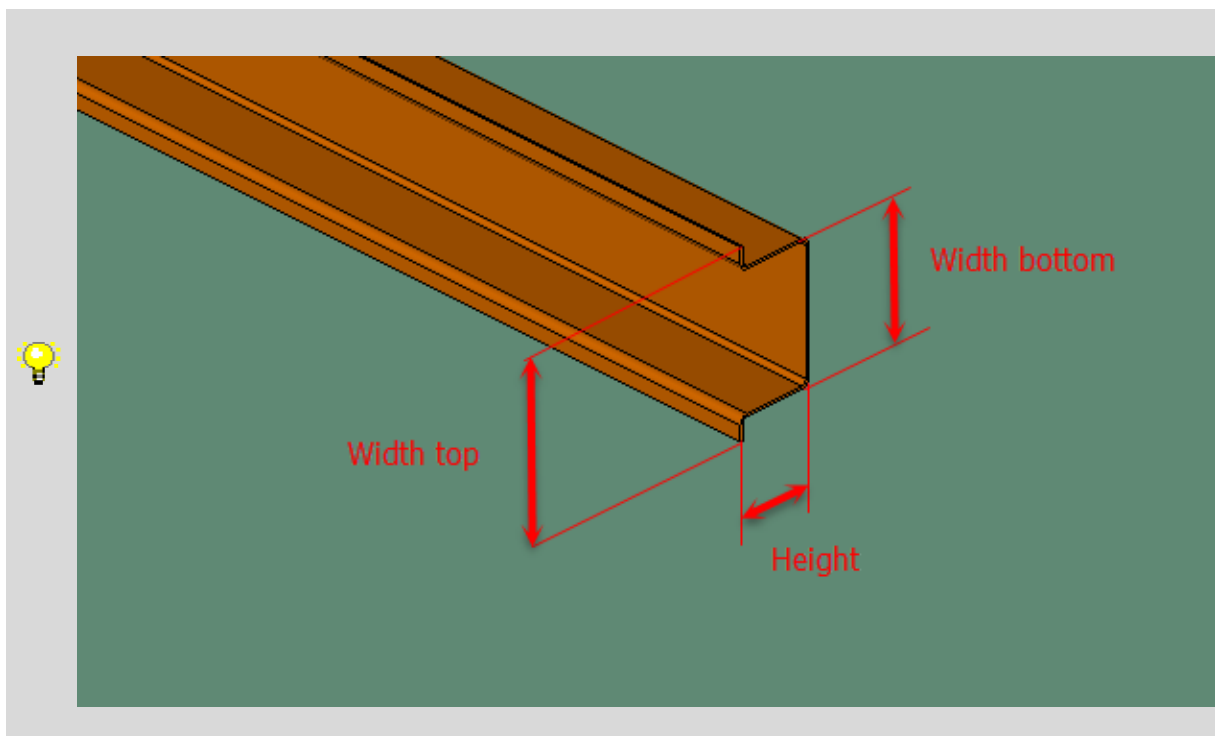

Graphical macro <22018>

For length-variable items if the dimension values are not used to shape a standard form of the above items, an Outline extrusion (.fc2) must be stored in this field. When defining an outline, the dimension values are then no longer considered.

If part is not a length-variable item, a 3D macro (.ema) file must be stored in this field instead of an Outline extrusion (.fc2).

Detailed information about outline extrusions can be found in the EPLAN Platform Online Help.

Creation of macros – General rules

Some articles need a representation in the circuit diagram that exceed the simple symbolics. This means that a macro is needed. In the specific chapters, the EPLAN Data Standard describes which display types and variants are necessary for the individual product groups. Here the general valid requirements are described, which are valid for all macro display types in this document. It is described in the specific chapters if there are necessary exceptions. In the downloadable macro project “EDS_Macroproject_20211029” the described templates and settings can be viewed and taken from.

Macro

Care must be taken for the provision of the article macros. The macro must be grouped with the macro box and the elements must be on the appropriate grid. The use of self-created or imported layers is not allowed. The format settings of the elements must be set to come "from layer". This guarantees the changeability of values (e.g. Size and Color) from within the layer management and to always suffice for the target project. Provided macros must be created as window macro (.ema). Macros, which are created with a special function template, build an exception. These macros must be necessarily saved as symbol macros (.ems)

Macro-Box

The macro box must be fitted to the size of the actual macro. For the final macro this means, the macro box must not be bigger than 4mm. An eventual macro created for the panel layout builds an exception. For this macro the macro box must be exactly on top of the part placement box without any distance.

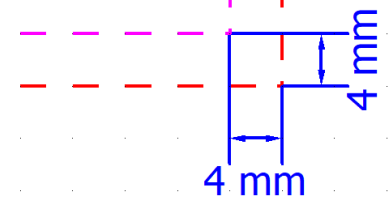

Figure 1 Distance of the Macro-Box

Furthermore, there are standardized property arrangements required which must be used unchanged for all macro boxes and are provided in the mentioned macro project.

Pay attention to the definition of the following properties which can be found under the “Settings” tab in the Macro box dialog.

Generate protected group during insertion

This checkbox must not be activated.

Also insert macro box

This option must be selected to “From project settings”.

Take connection point designations into account

Optional and must be set to one of the following options from the selection list:

From user settings <0> (default setting)

Yes <1>

No <2>

Record type: Manufacturer / Supplier

Tab: Address

Short name <22900> 

The short name corresponds to the manufacturer's abbreviation.

This is specified by EPLAN and can be requested from EPLAN if it does not already exist. The existing abbreviations can be viewed under the link below.

https://www.eplanusa.com/fileadmin/cloud/public/edp/Manufacturer_in_EDP.pdf

→ Current manufacturer

Full name <22908> 

The company name must be entered here without any legal additions. The full name is displayed as the manufacturer in the EPLAN Data Portal.



Instead of
EPLAN GmbH & Co. KG
just apply "EPLAN"

Title <22909>

Optional.

Name 1 <22910>

Optional.

Here you must enter the official company name, including legal additions.



EPLAN GmbH & Co. KG

Name 2 <22911>

Optional.

Name 3 <22912>

Optional.

Street

Optional.

Enter here the street and house number of the official company headquarters.

Zip code / City

Optional.

Enter the postcode of the official company headquarters here, without additional country code.



40789 Monheim am Rhein

Zip code / P.O. box:

Optional.

If available, enter the postal code of the company's official mailbox here, without additional country code.

Country

Optional.

Here you must enter in English the country where the official company headquarters is.



Germany

Phone

Optional.

Enter here the official telephone number of the company's registered office.

Example nationale telephone number:

01234 5678-910

Example international telephone number with country calling code:

+ 49 1234 5678-910

Fax

Optional.

Enter here the official number of the fax of the head office.

If you fill in this field, please note the requirements from the previous point phone

E-Mail

Optional.

Enter here the official e-mail address of the company headquarters.

Customer Number

Is reserved for the end user and must not be filled.

Description

Optional.

Pay attention to the definition in the chapter "[General definition > Multilingual fields](#)".

Record type: Part

Tab: General

Generic product group <22138> / Product group <22041> / Product subgroup <22028>



The part is to be classified in a meaningful and correct product group category. This classification is very important, because based on the selected product group certain properties in the parts management or certain functions are therefore also available in the platform.

Trade / subtrade

The correct trade must be selected for the part. An additional substructure is only permitted in the Fluid power trade.

Part number <22001>

In order to guarantee the uniqueness of the part number among all component manufacturers, this should correspond to the following structure:

<Manufacturer: Short name>.<Order number>



Manufacturer RITTAL → <Manufacturer: Short name > RIT
Order number: 8004000
Part number: RIT.8004000

Discontinued part

Is reserved for the end user and must not be filled.

ERP-Number

Is reserved for the end user and must not be filled.

Type number <22002>

The type number of the part must be entered here, this should correspond to the information in the manufacturer catalog. If there is no explicit type number, the order number must be entered.

Designation 1 <22004>

A short, concise description of the part must be entered in this field. For the selection, the fourth level of the eCl@ss categorization is recommended.

The length must not exceed 80 characters.

Technical parameters can be added in this field in such a way that clearly and concisely differentiates parts from each other in the Bill of Material report for example, which are from the same product family, but with different technical characteristics.

- F1 Circuit breaker 10KA 1POL C16
- F2 Circuit breaker 10KA 1POL C10
- F3 Circuit breaker 10KA 1POL B10







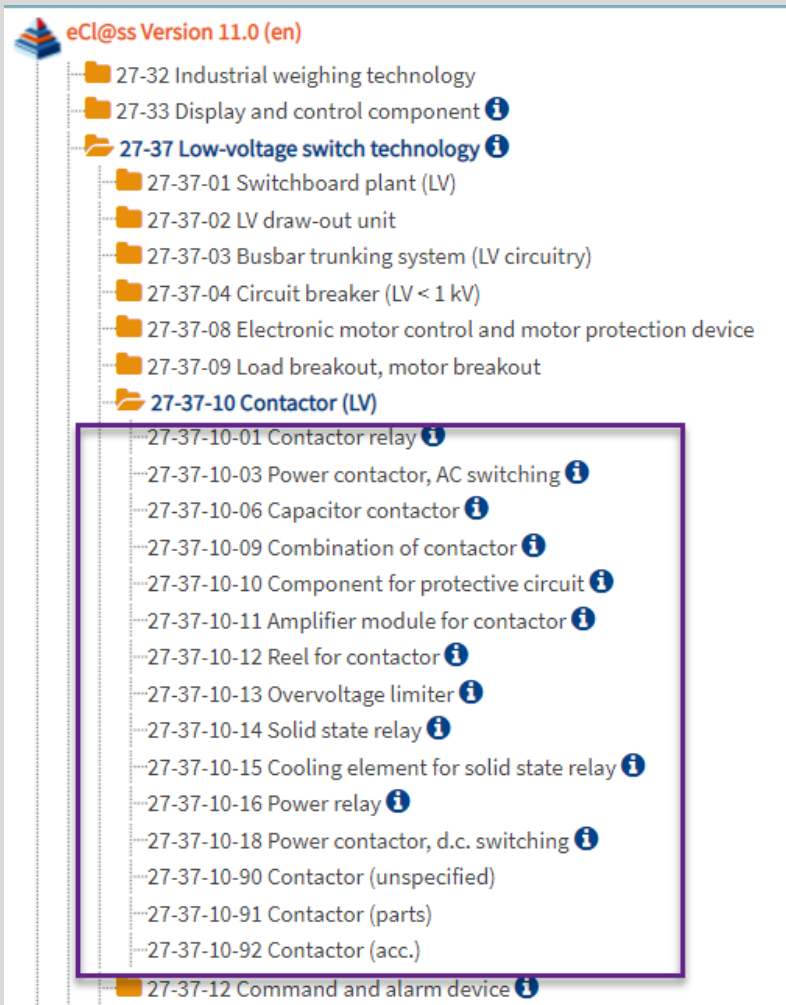







The description must be entered in a single-line text in this field, thus, line break character (¶) must not be used.

Technical parameters must be marked as excluded from translation. Pay attention to the definition in the chapter "[General definition > Multilingual fields](#)".

<https://www.eclasscontent.com/index.php?language=en>



eCl@ss Version 11.0 (en)

- 27-32 Industrial weighing technology
- 27-33 Display and control component 
- 27-37 Low-voltage switch technology **
 - 27-37-01 Switchboard plant (LV)
 - 27-37-02 LV draw-out unit
 - 27-37-03 Busbar trunking system (LV circuitry)
 - 27-37-04 Circuit breaker (LV < 1 kV)
 - 27-37-08 Electronic motor control and motor protection device
 - 27-37-09 Load breakout, motor breakout
 - 27-37-10 Contactor (LV)**
 - 27-37-10-01 Contactor relay 
 - 27-37-10-03 Power contactor, AC switching 
 - 27-37-10-06 Capacitor contactor 
 - 27-37-10-09 Combination of contactor 
 - 27-37-10-10 Component for protective circuit 
 - 27-37-10-11 Amplifier module for contactor 
 - 27-37-10-12 Reel for contactor 
 - 27-37-10-13 Overvoltage limiter 
 - 27-37-10-14 Solid state relay 
 - 27-37-10-15 Cooling element for solid state relay 
 - 27-37-10-16 Power relay 
 - 27-37-10-18 Power contactor, d.c. switching 
 - 27-37-10-90 Contactor (unspecified)
 - 27-37-10-91 Contactor (parts)
 - 27-37-10-92 Contactor (acc.)
 - 27-37-12 Command and alarm device 

Designation 2

Optional.

The description must be entered in a single-line text in this field, thus, line break character (¶) must not be used.

Pay attention to the definition in the chapter "[General definition > Multilingual fields](#)".

Designation 3

Is reserved for the end user and must not be filled.

Manufacturer <22007>

Here you can enter the short name from the specifications under Tab: Manufacturer.

Supplier

Is reserved for the end user and must not be filled.

Order number <22003>

Here the order number of the part is to be entered, this should correspond to the data of the manufacturer catalog.

Description

Optional.

Here an additional detailed description of the part can be deposited. This field is included in the full-text search (Portal + Platform).

Pay attention to the definition in the chapter "[General definition > Multilingual fields](#)".

Tab: Prices / Others

Price unit

Is reserved for the end user and should be set to "0".

Quantity unit <22042>

The unit of measure is to be filled in either "piece" or "meter", depending on how it is ordered. Abbreviations are not allowed.

Pay attention to the definition in the chapter "[General definition > Multilingual fields](#)".

Examples for translation:

de_DE	Stück	Meter
en_US	piece	meter
en_EN	piece	metre
cs_CZ	kus	metr
da_DK	styk	meter
es_ES	pieza	metro
fr_FR	pièce	mètre
hu_HU	darab	méter
it_IT	pezzo	metro
ja_JP	個	メートル
ko_KR	번호	미터
nl_NL	stuk	meter
pl_PL	sztuka	metr
pt_BR	peça	metro
pt_PT	peça	metro
ru_RU	на изделие	метр
sv_SE	styck	meter
tr_TR	adet	metre
zh_CN	件	米

Quantity / packaging

Optional.

Enter the number of units contained in a packaging unit.

Discount

Is reserved for the end user and should be set to "0,00 %".

Purchase price/ price unit

Is reserved for the end user and should be set to "0,00".

Purchase price/ packaging

Is reserved for the end user and should be set to "0,00".

Sales price

Is reserved for the end user and should be set to "0,00".

Barcode number / type

Optional.

If available, enter the GTIN code here.

Certification (General, UL certification, VDE certification, ATEX identifier, CE certification)

Optional.

If a certification is available, it should be registered here. The corresponding numbers must be listed separately by semicolon if necessary.

Tab: User-defined properties

Is reserved for the end user and must not be filled. Exceptions are the following properties (so-called EDS-defined properties) which are available exclusively for the EPLAN parts data providers in the EPLAN Data Portal and must be used if applicable. These properties will be used during the parts data validation process and in the EPLAN Data Portal but will not be accessible by the end user.

EDS.Part.EPLANAuxiliaryPart

This property is a Boolean field type to specify that the part does not exist in the manufacturer catalog. Therefore, it has a dummy part number in the EPLAN parts database, which is created for the sake of the 3D mounting layout functionality in EPLAN Pro Panel. Pay attention to the chapter [“Record type: Part > Tab: Assembly”](#) and to the “EPLAN Auxiliary Part” tab in the “EPLAN_Data_Standard_Product_group_overview” spreadsheet.

One purpose of creating such parts in the EPLAN parts database is to build up an assembly part that is to be placed in the 3D mounting layout in a distributed manner, meaning that separate 3D macros must be assigned to individual subassemblies (e.g., main switch distributed to panel and door). This kind of auxiliary part must be created under the “Component” Part type in the EPLAN Parts database.

Another purpose is to create an assembly part that is to be placed in the 3D mounting layout as a unit (e.g., a complete enclosure plinth with all pieces which are united into one 3D macro for the ease of placement in the 3D mounting layout), meaning that one 3D macro must be assigned to the assembly part, but it cannot be ordered via a single part number. Thus, each subassembly must be ordered individually because the assembly part has a dummy part number in the EPLAN Parts database and does not exist in the manufacturer catalog. This kind of auxiliary part must be created under the “Assembly” / “Module” Part type in the EPLAN Parts database.

EDS.Part.ItemDoesNotNeed3DMacro

This property is a Boolean field type to specify that the item does not require 3D mounting layout macro representation in the “Graphical macro” field because, for example, if the item is not a physical object such as a license for a PLC programmer or item is a field component such as a Valve, Converter, PLC, etc. This applies only to those Product group / subgroups which EDS defines that a 3D graphical macro must be provided.

EDS.Part.ItemDoesNotNeedCPP

This property is a Boolean field type to specify that the item does not have any electrical engineering connection point or fluid power connection point that requires connection point

pattern. This applies only to those Product group / subgroups which EDS defines that a connection point pattern must be provided.

EDS.Part.ItemDoesNotNeedDrill

This property is a Boolean field type to specify that the item does not require holes in the mounting surface in any mounting possibility. This applies only to those Product group / subgroups which EDS defines that a drilling pattern must be provided.

Call the “Configure properties” dialog from **Parts management > Extras > Configure properties** to import the EDS-defined properties (PcPm.EDS.xml) into your EPLAN Parts database, then call the below dialog to import the EDS scheme (PMcs.EDS.xml) into the User-defined properties tab.

The above xml files are provided in the EDS documentation package.

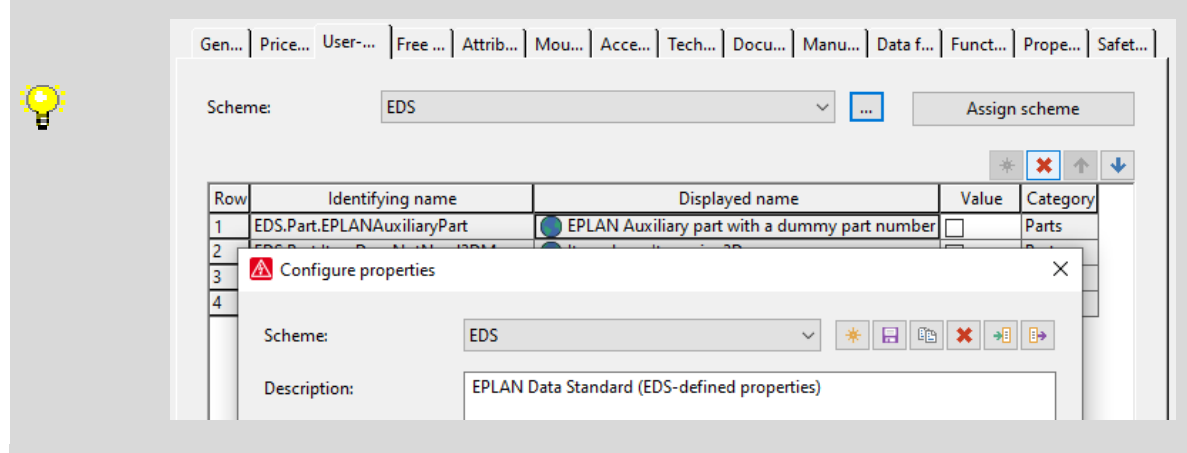

Tab: Free properties

Is reserved for the end user and must not be filled. Exceptions are some Free properties which are explained in a separate document exclusively for the EPLAN parts data providers in the EPLAN Data Portal and must be filled if applicable. These properties will be used in the EPLAN Data Portal but will not be accessible by the end user.

Tab: Attributes

Is reserved for the end user and must not be filled.

Tab: Mounting data

Weight <22046>

Enter the net weight of the part without packaging in kilograms [kg]. This field is used for the weight calculation of the control cabinet.

Width <22013>

Enter here the device-specific width in [mm].

Height <22012>

Enter here the device-specific height in [mm].

Depth <22014>

Enter here the device-specific depth in [mm].

When determining the width / height / depth, the device-specific installation position of the device must be assumed in the control cabinet and the dimensions of an imaginary cuboid body taken from the frontal view.

For mechanical components, please refer to the separate chapters.

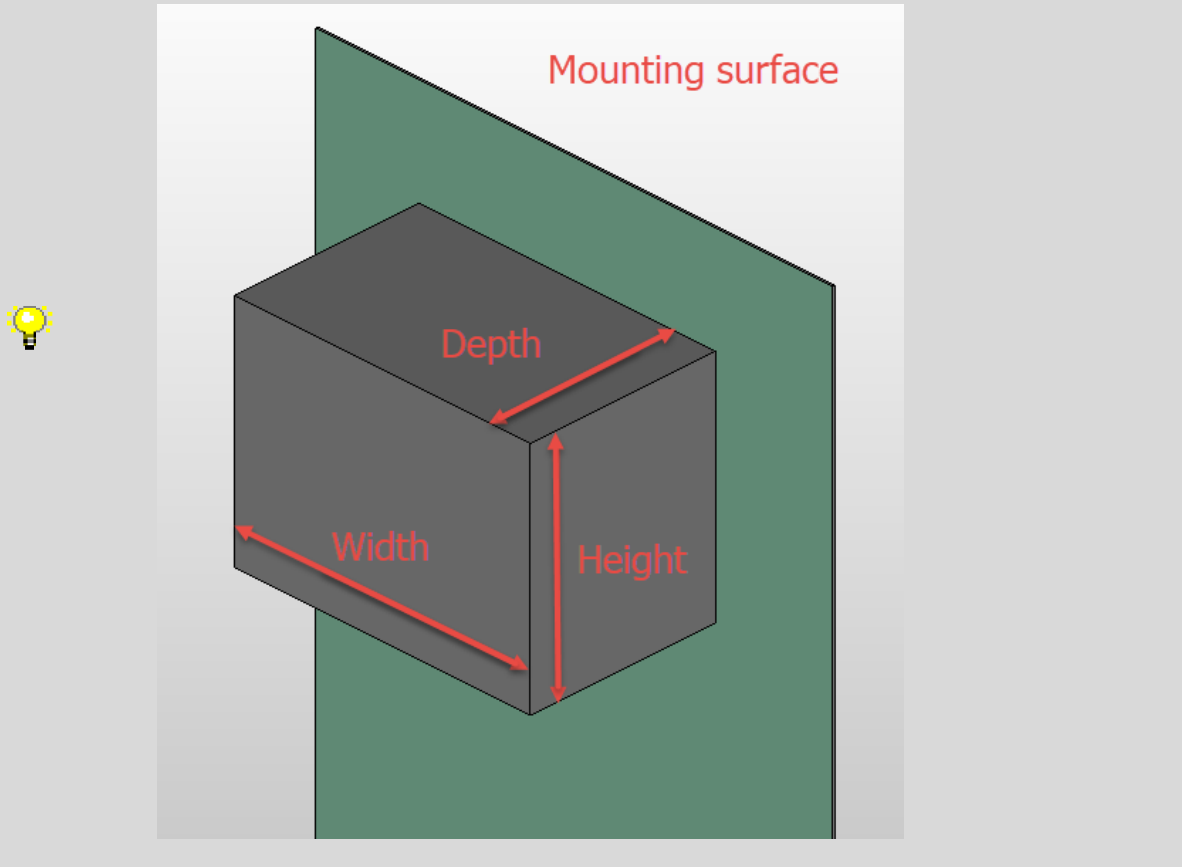

Space requirement

Optional.

This value is calculated when you select [Extras] > Space requirement. The values from the Width and Height fields are used. The following formula is applied: $w \cdot h$ where w = width and h = height.

Mounting surface

Is reserved for the end user and should be set to "Not defined".

External placement

Is reserved for the end user and must not be filled.

Graphical macro <2018>

In this field, enter the EPLAN macro with the representation type "3D mounting layout" and optionally "2D Panel layout" or an Outline extrusion (.fc2) for the length-variable items. Pay attention to the chapter "[General definitions > Length-variable items](#)". All other macro representation types (Multi-line, Single-line, Overview, etc.) must be defined in the Macro field under Technical data tab.

Pay attention to the path specifications of the folder structure and file name in the chapter "[General definition > Path specifications: creation of the folder structure and file names / references](#)".

Image file <22045>

A representative product image shall be indicated in this field. This is used as a preview image on the EPLAN Data Portal.

Pay attention to the path specifications of the folder structure and file name in the chapter „[General definition > Path specifications: creation of the folder structure and file names / references](#)“.



Valid image formats are:

jpg, jpeg, png or bmp

Center mismatch

It is not necessary to specify the center offset when using a 3D macro.

Clip-on height

It is not necessary to specify the clip-on height when using a 3D macro.

Mounting depth

It is not necessary to specify the mounting depth when using a 3D macro.

Texture

It is not necessary to specify the texture when using a 3D macro.

Mounting clearance Width / Height / Depth

These fields are for entry of the device-specific mounting clearances in [mm], from various aspects (thermal, mechanical, etc.). If you enter values in this field, the space requirement calculation ([Extras] > Space requirement) uses the following formula:

$((w+wc) * (h+hc))$, where w = width, wc = width mounting clearance, h = height, and hc = height mounting clearance.

Tab: Assembly

An assembly is a collection of parts belonging to one device (e.g., a pushbutton with a NO contact, the appropriate bracket, and the pushbutton head). The assembly has its own part number and can contain subassemblies.

Detailed information can be found in the EPLAN Platform Online Help.

For creating assemblies select the New popup menu item and, depending on the current selection, select Assembly entry from the subsequent menu.

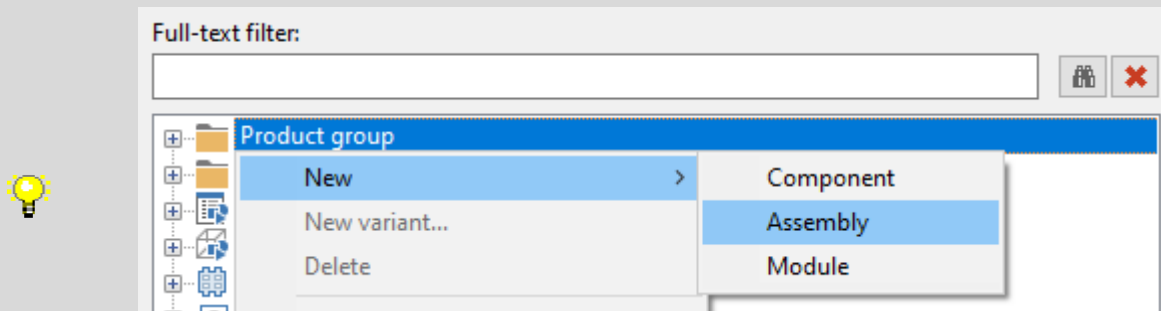

For assemblies, the Function template tab is greyed out and function definitions will be entered from the function definitions which are assigned to the subassemblies, automatically after calling the “Sum up function templates” from **Parts management > Extras > Sum up function templates**.

Distributed placement of assembly

Activate the checkbox if the assembly is to be placed in the 3D mounting layout in a distributed manner (e.g., main switch distributed to panel and door). In this case, 3D macros of individual physical items must be assigned to subassemblies.

Example 1) The below image on the right shows the distributed placement of SIEMENS SIMATIC IM 155-6PN/2 part which consists of an Interface Module and a Server Module (highlighted items -A00).

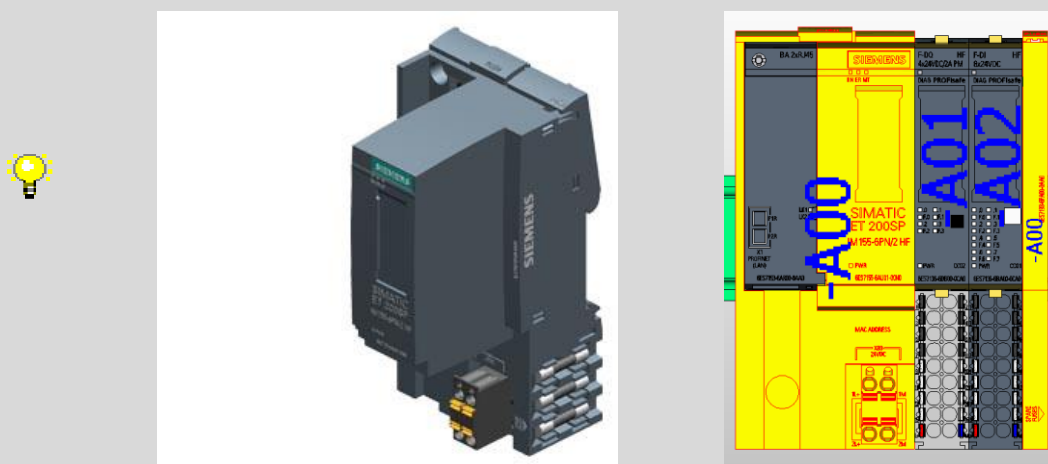

Deselect this check box for other assemblies that are placed together (e.g., a complete enclosure plinth with all pieces which are united into one 3D macro for the ease of placement in the 3D mounting layout). In this case, a 3D macro must be assigned to the assembly part.

Example 2) The below image on the left shows individual parts of a Rittal VX Plinth which must be assembled to become a complete plinth and the image on the right shows the 3D macro of the complete plinth which can be placed in the 3D mounting layout in one piece.

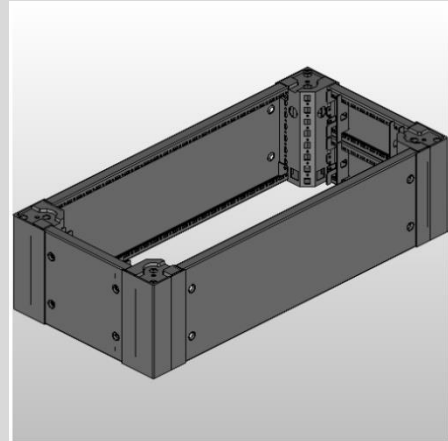

Break up in summarized parts list 

By means of the setting from this drop-down list you specify whether assemblies are to be broken up in the bill of material. The default value "From settings", is reserved for the end user and must not be used. Depending on how you want this assembly to be ordered, select "No" if the assembly itself should be listed in the bill of material or "Yes" if each subassembly must be listed individually in the bill of material.

Example 1) For the SIEMENS SIMATIC IM 155-6PN/2 (SIE.6ES7155-6AU01-0CN0) assembly part, this setting must be selected to "No" because when customer orders the Interface Module it always comes with the Server Module in one packaging.

The Server Module (SIE.6ES7193-6PA00-0AA0) can be ordered separately, but the Interface Module cannot be ordered without the Server Module. Therefore, you must create the Interface Module with a dummy part number (e.g., SIE.6ES7155-IM155-6PN2-HF) in EPLAN for the purpose of distributed placement of individual 3D macros in the 3D mounting layout.



General | Prices / ... | User-defi... | Free pro... | Attributes | Mountin... | **Assembly** | Accesso... | Technica...

Row	Quantity	Part number	Variant	Item number	Supplementary text	DT ID	Length
1	1	SIE.6ES7155-IM155-6PN2-HF	1				0.00 m
2	1	SIE.6ES7193-6PA00-0AA0	1				0.00 m

Pay attention to the sorting order of the subassemblies in the Assembly tab, especially for the assemblies which must be placed in a distributed manner.

Example 2) For the RITTAL VX Plinth (RIT.VX_base_RAL_9005_200_400x800) assembly part, this setting must be selected to “Yes” because this assembly part with a dummy part number does not exist in the Rittal’s catalog and it is created to simplifying the 3D design process in EPLAN Pro Panel by placing the complete plinth in the 3D mounting layout in one piece. Therefore, each individual subassembly must be listed in the bill of material report for the ordering purposes.

Row	Quantity	Part number	Variant	Item number	Supplementary text	DT ID	Length
1	2	RIT.8640021	1				0.00 m
2	2	RIT.8640044	1				0.00 m

When you create an assembly or subassembly with a dummy part number you must activate the “EDS.Part.EPLANAuxiliaryPart” checkbox in the User-defined properties tab to specify that the part has a dummy part number in EPLAN and does not exist in the manufacturer catalog. Pay attention to the chapter [“Record type: Part > Tab: User-defined properties”](#).

Quantity

This property must be equal to or greater than 1.

Part number

Enter the part number of subassembly in this field.

Variant

This field must be filled with the part’s variant designation.

Item number

Is reserved for the end user and must not be filled.

Supplementary text

Is reserved for the end user and must not be filled.

DT ID

Is reserved for the end user and must not be filled.

Length

Input in this column is only possible for parts with length specifications (for example cables, connections, lines / conduits, hoses), but not for parts from the "Mechanics" generic product group. For such a part, for example a cable, you can enter a part of the length here that you have stored at the part itself.

Tab: Accessories

The specification of accessories is optional.

Part is accessory

Optional.

This characteristic is to be set if this part is only an accessory for another part and cannot be used without it.

Required

Optional.

Check this box if the part is to contain a mandatory accessory part.

Part number / name

Select a part / part variant or an accessory list from the part selection.

Designation 1

This field is for displaying information only and will be filled automatically after the Part number / name has been chosen.

Variant

The relevant variant number of the part is displayed here. You can overwrite this entry if required.

Record type

This field is for displaying information only and will be filled automatically after the Part number / name has been chosen.

Accessory placement

Optional.

Select the accessory placement that is to be assigned to the respective component. For this purpose, the corresponding accessory placements must have been generated previously in the "Accessory placement" hierarchy level. Pay attention to the chapter "[Record type: Accessory placement](#)".

Note that the Accessory placement property is not available for accessory lists!

Tab: Technical data

Technical characteristics

Optional.

Group number

Is reserved for the end user and must not be filled.

Part group

Is reserved for the end user and must not be filled.

Function group

Is reserved for the end user and must not be filled.

Wearing part

Is reserved for the end user and must not be filled.

Spare part

Is reserved for the end user and must not be filled.

Lubrication / maintenance

Is reserved for the end user and must not be filled.

Service time 

Is reserved for the end user and must not be filled.

Stress 

Is reserved for the end user and must not be filled.

Procurement 

Is reserved for the end user and must not be filled.

Macro <22145> 

The EPLAN schematic macro must be entered in this field. The EPLAN schematic macro must be stored in this field. This macro may contain all representation types except "3D mounting layout".

Pay attention to the path specifications of the folder structure and file name in the chapter [„General definition > Path specifications: creation of the folder structure and file names / references“](#).

Connection point pattern: Name <22941> 

The correct connection point pattern must be entered here. If the component has different mounting positions, the respective connection point pattern must be stored as a local connection point pattern in the macro.

Connection point patterns are not mandatory for products used exclusively in the field. It is also permitted to store a local connection point pattern in the 3D-Macro. In this case, an additional connection point pattern must not be stored here.

Connection point pattern: Offset in X-direction <22277> 

A possible offset in X-direction in [mm] is to be indicated here.

Connection point pattern: Offset in Y-direction <22278> 

A possible offset in Y-direction in [mm] is to be indicated here.

Tab: Documents

File / Hyperlink <22280> 

Row 1 

In order to fulfill the EDS, the first row must be a hyperlink to the part's specific web page or PDF document on the Internet. If the part itself does not have a specific web page, a hyperlink to the manufacturer / supplier online catalog or alternatively the manufacturer / supplier main web page must be used.

It is recommended to provide a hyperlink in the following format: <company_web_address>/<part_number> (e.g., <https://www.wago.com/2200-1201>) where all the relevant product data such as Technical data, Commercial data, Approvals / Certificates, etc. for the part are documented and accessible in one place.

Row 2-20

Additional documents / hyperlinks can be specified optionally in row 2 to 20.

Pay attention to the path specifications of the folder structure and file name in the chapter "[General definition > Path specifications: creation of the folder structure and file names / references](#)"

Designation <22279>  

If the File / Hyperlink <22280 1-20> property is filled, then this property must be filled with a short, concise designation to describe the File / Hyperlink (e.g. en_US@Product details).

Pay attention to the definition in the chapter "[General definition > Multilingual fields](#)".

Tab: Manufacturing

Drilling pattern <22217> 

The correct drilling pattern of the article must be stored here.

Offset in X-direction <19605> 

A possible offset in X-direction in [mm] is to be indicated here.

Offset in Y-direction <19606> 

A possible offset in Y-direction in [mm] is to be indicated here.

Tab: Data for reports

Is reserved for the end user and must not be filled.

Tab: Function templates

The properties depend on the respective product group and are therefore explained in the respective product-specific chapters.

Tab: Properties

The properties depend on the respective product group and are therefore explained in the respective product-specific chapters.

Tab: Safety-related values

Is reserved for the end user and must not be filled.

Record type: Drilling pattern

Tab: Drilling pattern

Name <22931> 

The name of the drilling pattern is specified here. The name should be structured as follows:

<Manufacturer: Short name>.< AnyText >

Pay attention to the path specifications of the folder structure and file name in the chapter [„General definition > Path specifications: creation of the folder structure and file names / references“](#).

Description <22930>  

If several drilling patterns are assigned to an article for selection, a description must be stored for the purpose of differentiation. If only one drilling pattern can be selected, the description is optional.

Pay attention to the definition in the chapter [“General definition > Multilingual fields”](#).

Tab: Cut-outs 

The correct drilling pattern must be stored here.

Tab: Attributes 

Is reserved for the end user and must not be filled.

Record type: Connection point pattern

Tab: Connection point pattern

Name <22945> 

The name of the Connection point pattern is specified here. The name should be structured as follows:

<Manufacturer: Short name>.<AnyText>

Pay attention to the path specifications of the folder structure and file name in the chapter [„General definition > Path specifications: creation of the folder structure and file names / references“](#).

Description <22946> 

Optional.

Here an additional short description of the connection point pattern can be added.

Pay attention to the definition in the chapter [“General definition > Multilingual fields”](#).

Standard connection point: Connection category 

Is reserved for the end user and should be set to "Undefined".

Standard connection point: Connection dimension 

Is reserved for the end user and must not be filled.

Standard connection point: Wire termination processing (EPLAN Cabinet) 

Is reserved for the end user and should be set to "Undefined".

Standard connection point: Additional length 

Is reserved for the end user and should be set to "0".

Standard connection point: Routing direction 

Is reserved for the end user and should be set to "Automatic"

Tab: Connection points

Connection point designation 

The designation of the respective connection must be entered here. If the connection point pattern is for terminals, this field must not be filled.

Plug designation 

If a plug designation has been assigned for device or PLC connections, it must be entered here.

Level 

Mandatory field only for terminals. Enter the floor of the terminal here.

Internal / External index 

This field must not be filled, as a unique connection designation is required for terminals.

X/Y/Z Position 

Enter here the distance of the connection in X/Y/Z direction from the zero point (along the component width).

Routing direction 

Here you can select the connection point direction from the list.

X/Y/Z vector 

These values define the vector of the wiring direction

Additional length 

Is reserved for the end user and must not be filled.

Connection category 

Select the correct connection version from the list below.

See the how to do chapter for more information.

Connection dimension 

This information is only relevant for some certain connections categories.

See the how to do chapter for more information.

Min. cross-section 

The minimum permissible wire cross section in [mm²] must be specified here. This information is mandatory if a single wire will be connected. If different types of wires (e.g. rigid, open-wire) have different cross-sections defined, the largest is specified.

This information is only relevant for some certain connections categories.

See the how to do chapter for more information.

Max. cross-section 

The maximum permissible wire cross section in [mm²] must be specified here. Exceptions see "Min. cross-section". In case of different wire types (e.g. rigid, free-stranded) and different cross-sections are defined, the smallest is specified in each case.

This information is only relevant for some certain connections categories.

See the how to do chapter for more information.

Max. number of connections 

Here the number of maximum connections allowed at the connection must be specified.

This information is only relevant for some certain connections categories.

See the how to do chapter for more information.

Dual sleeve prescribed 

Here it is necessary to determine whether double sleeves are prescribed at this connection when connecting 2 wires or not.

Min. AWG 

Here the minimum permitted wire cross-section must be specified in [AWG] (numeric value without unit).

This information is only relevant for some certain connections categories.

See the how to do chapter for more information.

If the item is not available in the US or Canadian market, this information is optional.

Max. AWG 

Here the maximum permitted wire cross-section must be specified in [AWG] (numeric value without unit).

This information is only relevant for some certain connections categories.

See the how to do chapter for more information.

If the item is not available in the US or Canadian market, this information is optional.

Socket size 

This information is only relevant for some certain connections categories.

See the how to do chapter for more information.

Min. tightening torque 

If no minimum and maximum value is defined, but only a single value, the following values are defined in min. and max is the identical value.

This information is only relevant for some certain connections categories.

See the how to do chapter for more information.

Max. tightening torque 

See Min. tightening torque.

Stripping length 

The length in millimeters on which the wire assembly machine should strip the insulation, must be entered here.

This information is only relevant for some certain connections categories.

See the how to do chapter for more information.

Bus interface: Name

Optional.

Tab: Attributes 

Is reserved for the end user and must not be filled.

Connection point pattern – How to do

This chapter describes the recommended procedure for creating connection point pattern. In particular, the effects of the connection category on the corresponding properties. The properties to be filled depend on the connection category. See an overview in the Excel sheet "EPLAN_Data_Standard_Product_group_overview_<release_date>" on the "Connection point pattern" tab.

The 3D connection point pattern only lists connections or terminals which are connected via a single wire. This also includes wires that are bundled as cables in the further course of the installation. The situation at the connection point (terminal strip) of the electrical components is decisive.

Electrical connections which are connected to a product by multi-pole plugs or sockets are not included in the 3D connection diagram. Usually, these are connections that are made using prefabricated cables. Typical examples are:

- Network connection / RJ45
- USB
- Mx- sockets / plugs (e.g. M8, M12)
- Sub-D

Likewise, the following connection situations are not included in the 3D connection point pattern:

- Connection point where the braided shield of a cable is connected to the housing, e.g. by clamping to a shielding plate
- electrical connections that are made without connecting a wire via mechanical contact elements between each other or automatically by the mechanical assembly of two components, e.g. backplane bus.

Only the following listed connection categories are to be used to create the connection point pattern:

Electrical engineering	Fluid power
Screw connection	Plug-in connection
Spring pulley connection	Push-wire connection
Push-in connection	Internal thread
Penetration connection	External thread
Insulation-displacement connection	
Bolt connection	
Flat plug-in connector	
Crimp connection	
Band connection	
Rail connection	
Soldering lug connection	
Wrap post	

Screw connection



Picture 2 Phoenix Contact (3044076)

Property	Value
Connection category	Screw connection
Connection dimension	
min. cross-section	0,14 mm ²
max. cross-section	4 mm ²
Min. AWG	26
Max. AWG	12
Max. number of connections	2
Dual sleeve prescribed	False
Socket size	PZ2
Min. tightening torque	0,5 Nm
Max. tightening torque	0,5 Nm
Stripping length	9 mm

Spring pulley connection



Picture 3 Phoenix Contact (3031076)

Property	Value
Connection category	Spring pulley connection
Connection dimension	
min. cross-section	0,08 mm ²
max. cross-section	1,5 mm ²
Min. AWG	28
Max. AWG	16
Max. number of connections	1
Dual sleeve prescribed	False
Socket size	
Min. tightening torque	
Max. tightening torque	
Stripping length	9 mm

Push-in connection



Picture 4 Phoenix Contact (3208130)

Property	Value
Connection category	Push-in connection
Connection dimension	
min. cross-section	0,14 mm ²
max. cross-section	1,5 mm ²
Min. AWG	26
Max. AWG	14
Max. number of connections	1
Dual sleeve prescribed	False
Socket size	
Min. tightening torque	
Max. tightening torque	
Stripping length	8 mm

Penertration connection



Picture 5 Phoenix Contact (3050031)

Property	Value
Connection category	Penertration connection
Connection dimension	
min. cross-section	0,5 mm ²
max. cross-section	2,5 mm ²
Min. AWG	20
Max. AWG	14
Max. number of connections	1
Dual sleeve prescribed	False
Socket size	
Min. tightening torque	
Max. tightening torque	
Stripping length	9 mm

Insulation-displacement connection



Picture 6 Siemens (8WH3003-0CE07)

Property	Value
Connection category	Insulation-displacement connection
Connection dimension	
min. cross-section	0,25 mm ²
max. cross-section	1,5 mm ²
Min. AWG	24
Max. AWG	16
Max. number of connections	1
Dual sleeve prescribed	False
Socket size	
Min. tightening torque	
Max. tightening torque	
Stripping length	9 mm

Bolt connection

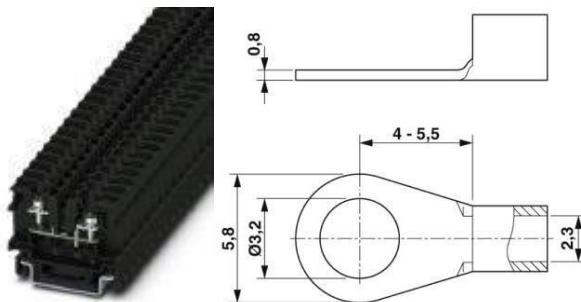

Picture 7 Phoenix Contact (3281103)

Property	Value
Connection category	Bolt connection
Connection dimension	3,2 mm
min. cross-section	0,5 mm ²
max. cross-section	1,25 mm ²
Min. AWG	26
Max. AWG	12
Max. number of connections	2
Dual sleeve prescribed	
Socket size	PZ2
Min. tightening torque	0,6 Nm
Max. tightening torque	1 Nm
Stripping length	

Flat plug-in connector



Picture 8 Phoenix Contact (1953017)

Property	Value
Connection category	Flat plug-in connector
Connection dimension	2,8x0,8 mm
min. cross-section	0,5 mm ²
max. cross-section	6 mm ²
Min. AWG	20
Max. AWG	10
Max. number of connections	1
Dual sleeve prescribed	False
Socket size	
Min. tightening torque	
Max. tightening torque	
Stripping length	

Rail connection

Property	Value
Connection category	Rail connection
Connection dimension	6x3 mm
min. cross-section	
max. cross-section	
Min. AWG	
Max. AWG	
Max. number of connections	
Dual sleeve prescribed	
Socket size	
Min. tightening torque	
Max. tightening torque	
Stripping length	

Plug-in connection / Push-wire connection / Internal thread / External thread

Property	Value	Value	Value	Value
Connection category	Plug-in connection	Push-wire connection	Internal thread	External thread
Connection dimension	8 mm	8 mm	G 1/8"	G 1/8"
min. cross-section				
max. cross-section				
Min. AWG				
Max. AWG				
Max. number of connections				
Dual sleeve prescribed				
Socket size				
Min. tightening torque				
Max. tightening torque				
Stripping length				

Devices with two or more connection rooms

Some products offer the possibility to connect several wires for the same identical connection in separate terminal or connection rooms. The rooms or connection possibilities are electrically connected to each other. From the point of view of a circuit diagram the separate rooms represent a single electrical connection or connection point. For each room separate coordinates can be determined. Therefore, each room - even if the connection designation is identical - is listed separately with the corresponding coordinates in the 3D connection point pattern.

The listing of the connections in sequence of the corresponding rooms is independent of the information in the function template of the article. This means that even if the connection is mentioned several times in the 3D connection point pattern, it is only mentioned once in the function template.



Abbildung 9 Siemens

Example for a device with the connection designation "1L1" with two connection rooms within one screw connection

Connection point designation	Plug designation	Level	Internal / External index	X position	Y position	Z position	Routing direction
1L1		0	Undefined	11,55 mm	109,85 mm	57,90 mm	Move up
1L1		0	Undefined	14,55 mm	109,85 mm	57,90 mm	Move up



Picture 10 Siemens

Example for a device with the connection designation "1L1" with two connection rooms with two spring pulley connections:

Connection point designation	Plug designation	Level	Internal / External index	X position	Y position	Z position	Routing direction
1L1		0	Undefined	11,55 mm	109,85 mm	57,90 mm	Move up
1L1		0	Undefined	14,55 mm	109,85 mm	57,90 mm	Move up

Record type: Accessory placement

Tab: Accessory placement

Name <22970> 

The name of the accessory placement is specified here. The name should be structured as follows:

<Manufacturer: Short name>.< AnyText >

Pay attention to the path specifications of the folder structure and file name in the chapter [„General definition > Path specifications: creation of the folder structure and file names / references“](#).

Description <22974> 

Insert here the description of the accessory placement.

Pay attention to the definition in the chapter [“General definition > Multilingual fields”](#).

Tab: Placement

Installation variant 

Insert here the description of the installation variant



Base point 

Insert here the defined mounting points in a layout space.

Rotation 

Select here by drop down menu the suitable rotation.

Offset in X/Y/Z-direction 

If there is an offset for the automatic placement, insert here the correct value.

Can be moved 

If this installation variant can be moved in the enclosure, the checkbox should be set.

Tab: Attributes

Is reserved for the end user and must not be filled.

Record type: Accessory list

Tab: Accessory list

Name <22960> 

The name of the accessory list is specified here. The name should be structured as follows:

<Manufacturer: Short name>.< AnyText >

Pay attention to the path specifications of the folder structure and file name in the chapter „[General definition > Path specifications: creation of the folder structure and file names / references](#)“.

Description <22959> 

Optional.

Pay attention to the definition in the chapter “[General definition > Multilingual fields](#)”.

Tab: Parts

Part number 

Select a part / part variant from the part selection. Note that only accessories (parts with the activated “Part is accessory” checkbox under the Accessories tab) are available to be entered in this field.

Designation 1 

The Designation 1 field is filled automatically. The field is for displaying information only and is grayed out.

Variant 

The relevant variant number of the part is displayed here. You can overwrite this entry if required.

Accessory placement

Optional.

Select the accessory placement that is to be assigned to the respective component. For this purpose, the corresponding accessory placements must have been generated previously in the "Accessory placement" hierarchy level. Pay attention to the chapter “[Record type: Accessory placement](#)”.

Tab: Attributes

Is reserved for the end user and must not be filled.

Specific data fields for Terminals

Pay attention to the main definitions in the chapter "[Record type: Part](#)".

Tab: Properties: Terminal data

Color <22080>  

Enter the colour of the terminal here. The value shall be stated in full and no abbreviations shall be used.

Pay attention to the definition in the chapter "[General definition > Multilingual fields](#)".



Material <22081> 

Optional.

The material from which the insulating body of the terminal is made must be entered here.

Pay attention to the definition in the chapter "[General definition > Multilingual fields](#)".

Terminals: Degree of protection <22082> 

Optional.

Pay attention to the definition in the chapter "[General definition > Multilingual fields](#)".

Connection point cross-section <22036>

Optional.

Max. power dissipation <22074> 

Enter the maximum power dissipation per pole in Watt (Voltampere) with the corresponding unit [W] (VA). This is essential for the thermal calculation in Pro Panel.

Alignable <22229> 

Since terminals can always be arranged in a row, the checkbox for terminals must always be set. This checkbox must also be activated for accessories that can be arranged in a row.

Terminals: Cross-section from <22084> 

Enter the minimum connectable conductor cross-section in [mm²], indicating the unit. If for different wire types (e.g. rigid, free-stranded) different cross-sections are defined, the value from cross-section fine wire with conductor end sleeve must be selected.

If the item is only available in the US or Canadian market, this information is optional.

Terminals: Cross-section to <22085> 

Enter the maximum connectable conductor cross-section in [mm²], indicating the unit. If for different wire types (e.g. rigid, free-stranded) different cross-sections are defined, the value from cross-section fine wire with conductor end sleeve must be selected.

If the item is only available in the US or Canadian market, this information is optional.

Terminals: AWG from <22086> 

Enter the minimum connectable conductor cross-section in [AWG] (numeric value without unit). If for different wire types (e.g. rigid, free-stranded) different cross-sections are defined, the value from cross-section fine wire with conductor end sleeve must be selected.

If the item is not available in the US or Canadian market, this information is optional.

Terminals: AWG to <22087> 

Enter the maximum connectable conductor cross-section in [AWG] (numeric value without unit). If for different wire types (e.g. rigid, free-stranded) different cross-sections are defined, the value from cross-section fine wire with conductor end sleeve must be selected.

If the item is not available in the US or Canadian market, this information is optional.

Current <22071>

Optional.

Voltage <22033>

Optional.

Terminals: Current IEC <22088> 

The rated current in Ampere, with the corresponding unit [A], is to be entered here.

This field is optional for pure PE terminals.

If the item is only available in the US or Canadian market, this information is optional.

Terminals: Voltage IEC <22089> 

The rated voltage in Volt, with the corresponding unit [V], is to be entered here.

This field is optional for pure PE terminals.

If the item is only available in the US or Canadian market, this information is optional.

Terminals: Current UL <22090>

Optional.

Terminals: Voltage UL <22091>

Optional.

Terminals: Current CSA <22092>

Optional.

Terminals: Voltage CSA <22093>

Optional

Tab: Function templates

Detailed information and concrete examples for the presentation and structure of the function template of terminals can be found in the chapter "[Terminals – How to do](#)".

Function definition

The correct function definition must be entered here.

Connection point designations

This field must be filled correctly. The connection designation must be indicated in lowercase letters or numbers.



If fixed designations are printed on the terminals, these must be used even if they contradict the above specifications.

Connection point descriptions

Is reserved for the end user and must not be filled.

Connection point cross-section / diameter

Is reserved for the end user and must not be filled.

Connection dimension

Is reserved for the end user and must not be filled.

Subordinate DT / DT ID <21005>

Is reserved for the end user and must not be filled.

Terminal / Pin designation

Is reserved for the end user and must not be filled.

Terminal / Pin description

Is reserved for the end user and must not be filled.

Level

In this field, in the case of a multilevel terminal block, the corresponding level must be entered. If the terminal is not a multilevel terminal, level 0 must be selected here.



In case of multilevel terminals, function definitions which belong to each terminal level, must be sorted from highest level to the lowest level, meaning that the first row in the Function template tab must represent the function definition of the highest terminal level.

Level 0 must not be used in multilevel terminals.

Pay attention to the chapter "[Terminals – How to do](#)".

Safety function

If this is a safety function, set this checkbox.

Intrinsically safe

If the function is intrinsically safe, set this checkbox.

Symbol

Is reserved for the end user and must not be filled.

Symbol macro

Optional.

Terminal category

The design of the terminal must be entered here. The possible values are given and can be found in the following list:



For further information please refer to the EPLAN Platform Online Help

Terminal with LED

If the terminal has an integrated LED, this checkbox must be set.

Terminal with plug-in adapter

If the terminal has a plug-in adapter, this checkbox must be set.

Description

Is reserved for the end user and must not be filled.

Template group (multi-line) <21023>

Optional.

In this field a uniform number or designation for two or more function definitions can be entered. Function definitions with the same Template group designation will be combined into one logical unit. Therefore, if one of these functions is marked in the navigator, all the functions of the template group are placed at the same time - together with the part stored at the macro.

Labeling type

Is reserved for the end user and must not be filled.

Terminals – How to do

This chapter shows how the function templates for different terminals should be designed.

Feed-through terminal with bridge possibility



Figure 1 for example Phoenix Contact (3031212)

Row	Function definition	Connection designations	point	Level	Safety function	Intrinsically safe	Terminal category	Terminal with LED	Terminal with plug-in adapter
1	Terminal with saddle jumper, 2 connection points	a b		0	FALSE	FALSE	Feed-through terminal	FALSE	FALSE

Feed-through terminal with bridge possibility



Figure 2 for example Phoenix Contact (3209578)

Row	Function definition	Connection designations	point	Level	Safety function	Intrinsically safe	Terminal category	Terminal with LED	Terminal with plug-in adapter
1	Terminal with saddle jumper, 4 connection points	a b c d		0	FALSE	FALSE	Feed-through terminal	FALSE	FALSE

Three-level terminal with PE rail contact



Figure 3 for example Phoenix Contact (0461018)

Row	Function definition	Connection point designations	Level	Safety function	Intrinsically safe	Terminal category	Terminal with LED	Terminal with plug-in adapter
1	Terminal with saddle jumper, 2 connection points	e f	3	FALSE	FALSE	Feed-through terminal	FALSE	FALSE
2	Terminal, 2 connection points	c d	2	FALSE	FALSE	Feed-through terminal	FALSE	FALSE
3	PE terminal with rail contact, 1 connection point	b	1	FALSE	FALSE	Feed-through terminal	FALSE	FALSE

Sensor/Actuator Terminal Block

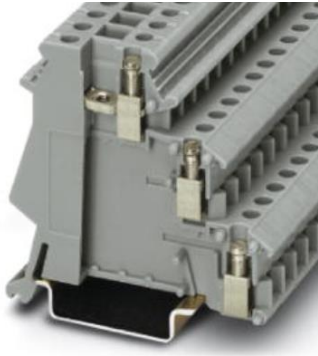

Figure 4 for example Phoenix Contact (2715966)

Row	Function definition	Connection point designations	Level	Safety function	Intrinsically safe	Terminal category	Terminal with LED	Terminal with plug-in adapter
1	Terminal with saddle jumper, 2 connection points	e/f	3	FALSE	FALSE	Feed-through terminal	FALSE	FALSE
2	Terminal, 1 connection point	d	2	FALSE	FALSE	Feed-through terminal	FALSE	FALSE
3	Terminal, 1 connection point	b	1	FALSE	FALSE	Feed-through terminal	FALSE	FALSE



In case of multi-level terminals, the assignment of the connection point designation must be observed. The designation always starts on the internal side and is continued. If only one connection is available for a level (see example in Figures 4 & 5) and thus e.g. the connection is missing on the internal side, the corresponding connection designation must also be omitted.

Potential distributors



Figure 5 for example Phoenix Contact (3031047)

Row	Function definition	Connection point designations	Level	Safety function	Intrinsically safe	Terminal category	Terminal with LED	Terminal with plug-in adapter
1	Terminal with saddle jumper, 9 connection points	a b c d e f g h i	0	FALSE	FALSE	Feed-through terminal	FALSE	FALSE

Quadruple-deck terminal block with PE terminal in level 1

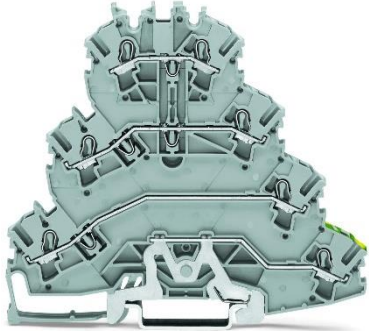

Figure 6 for example WAGO (2002-4127)

Row	Function definition	Connection point designations	Level	Safety function	Intrinsically safe	Terminal category	Terminal with LED	Terminal with plug-in adapter
1	Terminal with saddle jumper, 2 connection points	g h	4	FALSE	FALSE	Feed-through terminal	FALSE	FALSE
2	Terminal with saddle jumper, 2 connection points	e f	3	FALSE	FALSE	Feed-through terminal	FALSE	FALSE
3	Terminal with saddle jumper, 2 connection points	c d	2	FALSE	FALSE	Feed-through terminal	FALSE	FALSE
4	PE terminal with rail contact, 1 connection point	b	1	FALSE	FALSE	Feed-through terminal	FALSE	FALSE

Quadruple-deck terminal block with blank terminal in level 1

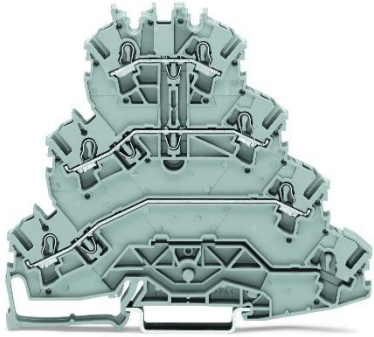

Figure 7 for example WAGO (2002-4101)

Row	Function definition	Connection point designations	Level	Safety function	Intrinsically safe	Terminal category	Terminal with LED	Terminal with plug-in adapter
1	Terminal with saddle jumper, 2 connection points	g h	4	FALSE	FALSE	Feed-through terminal	FALSE	FALSE
2	Terminal with saddle jumper, 2 connection points	e f	3	FALSE	FALSE	Feed-through terminal	FALSE	FALSE
3	Terminal with saddle jumper, 2 connection points	c d	2	FALSE	FALSE	Feed-through terminal	FALSE	FALSE



In case of multilevel terminals, blank terminal levels (e.g. level 1 for above terminal) must be skipped in the Function template.

Specific data fields for Cables

Pay attention to the main definitions in the chapter "[Record type: Part](#)".

Tab: Properties: Cable data

Cable type / Type designation <22030> 

The type designation of the cable must be entered here.

The entry is limited to 40 characters.



ÖLFLEX® CLASSIC 100

Number of connections <22031> 

The number of connections in the cable must be entered here.

The entry is limited to 6 characters.

Length (prefabricated) <22055> 

For prefabricated cables, the length in Meters, with the corresponding unit [m], must be entered here.

In the case of spiral cables, the length of the cable after extension is decisive.

Connection: Cross-section / diameter <22032> 

Here the cross section of the connection, without indication of the corresponding unit, is to be entered. If there are several different cross-sections in the cable, the specification must be separated by a slash (/) without spaces.



0,14/0,5

Unit for connection cross-section / diameter <22068> 

The corresponding unit that was used in the property "Connection: Cross-section / diameter" is to be entered here.



Possible values are predefined and can be taken from the EPLAN Platform Online Help.

No. of connections and cross-section / diameter <22069> 

The number of connections with cross section must be entered here. Different cross-sections can be indicated by a "+".



3x1,5

3G2,5

10x0,14+2x0,5

10x0,25 +(2x1,5) + (3x0,5)

Cable / Conduit: Designation in graphic <22064> 

Is reserved for the end user and must not be filled.

Image file <22045>

A representative product image shall be entered in this field. This is used as a preview image on the EPLAN Data Portal.

Pay attention to the path specifications of the folder structure and file name in the chapter „[General definition > Path specifications: creation of the folder structure and file names / references](#)“.

Cable assignment diagram form <22034>

The end user is reserved and must not be filled.

Voltage <22033>

The rated voltage of the cable, with the corresponding unit [V], must be entered here. If multiple entries are necessary, the voltages must be separated by a forward slash (/) without spacings.

The entry is limited to 10 characters.



External diameter <22065>

Enter the outer diameter of the cable in millimeter, with the corresponding unit [mm]. In case of flat cables, the width shall be expressed in millimeter with the corresponding unit [mm].

The entry is limited to 16 characters.

Min. bending radius <22063>

Enter the minimum bending radius of the cable in millimeter, with the corresponding unit [mm].

Copper weight <22066>

Optional.

The copper content in [kg/km] in the cable must be entered here.

The input is limited to 10 characters.

Weight / length <22067>

Optional.

Enter the weight of the cable in [kg/km].

The input is limited to 10 characters.

Intrinsically safe <22114>

If the cable is intrinsically safe and it is ensured that no spark is generated during operation or in the event of a short circuit which could ignite any explosive atmosphere (gas or liquid), the checkbox must be set.

Short-circuit proof <22115>

If the cable is sure about short circuit, i.e. it is guaranteed that the cable also does not burn with a short circuit between the single veins, this check box is to be selected.

Tab: Function templates

Detailed information and concrete examples for the presentation and structure of the function template of terminals can be found in the chapter "[Cable – How to do](#)".

Function definition

The correct function definition must be entered here.



For the prefabricated cables it is necessary to have at least one cable definition. The function template could be extended as specified below.

Subordinate DT / DT ID <21005>

Is reserved for the end user and must not be filled.

Intrinsically safe

If the function is intrinsically safe, this checkbox must be set.

Description

Optional.

Pay attention to the definition in the chapter "[General definition > Multilingual fields](#)".

Template group (multi-line) <21023>

Optional.

In this field a uniform number or designation for two or more function definitions can be entered. Function definitions with the same Template group designation will be combined into one logical unit. Therefore, if one of these functions is marked in the navigator, all the functions of the template group are placed at the same time - together with the part stored at the macro.

Connection color / number

The color code according to IEC 60757 must be used as designation in case it contains wires with different colors. The codes will be extended according the wire numbering if the cable contains wire of the same color, e.g: BK1, BK2, BK3, RD1, RD2, etc. The color code does not have to be specified, if the cable contains only wires with identical color. In this case only the numbering is indicated: 1, 2, 3, etc. A shielding is generally designated with 'SH'. Multiple shields are numbered in sequence: SH1, SH2, SH3, etc. Under no circumstances, must there be wires with an identical designation. If a color is not listed in the table IEC 60757, a suitable two-digit abbreviation must be selected.

For bright shades, letter 'L' must be placed in front of the existing color code (Light Blue → LBU).

For dark shades, letter 'D' must be placed in front of the existing color code (Dark Blue → DBU).

For cable cores with multiple colors, the combination of colors must be selected from the definition of IEC 60757 from top to bottom. (Red-Blue cable core → RDBU). If a color is dominating, it must be set first. (White cable core with blue stripes → WHBU)



Black – BK
Brown – BN
Red – RD

Orange – OG
 Yellow – YE
 Green – GN
 Blue – BU
 Violet – VT
 Grey – GY
 White – WH
 Pink – PK
 Turquoise – TQ
 Green-Yellow – GNYE
 Gold – GD
 Silver - SR

In the first instance, the individual cores of a prefabricated cable are designated in the same way as those of a standard cable.

Deviating designations are allowed in case no useful documentation in the circuit diagram can be achieved in this way.

Such a deviation may be necessary, e.g:



- If the cores or the routing cannot be clearly described by colour codes alone
- A simple numbering of the cores (1...x) cannot clearly reflect the internal wiring in the cable, especially the relationship between the connection elements (plug/socket) at the end of the cable

In this case, the chosen designation should help the user to understand the routing within the cable.

Connection: Cross-section / diameter

In the case of connections, the cross-section without unit is to be entered here.

Shielded by

If the cable, individual connections or a shield is shielded, the name of the shield must be entered here. This name must match the given name and connection color / number of the shield.

Pair index

The pair index applies to paired wires. If this is the case, enter 1.1 for the first wire and 1.2 for the second wire.

Potential type

For PE connections or shields, the correct potential must be entered (PE or SH). For all other potentials "undefined" should be selected.



Possible values are predefined and can be taken from the EPLAN Platform Online Help.

Pipe class

Not used for cables.

Cable – How to do

This chapter shows how the function templates for different cables should be designed.

ÖLFLEX® CLASSIC 110 4G1,5



Figure 6 for example LAPP (1119304) or similar

Row	Function definition	Intrinsically safe	Connection color / number	Connection: Cross-section / diameter	Shielded by	Pair index	Potential type
1	Cable definition	FALSE					
2	Conductor / wire	FALSE	1	1,5			Undefined
3	Conductor / wire	FALSE	2	1,5			Undefined
4	Conductor / wire	FALSE	3	1,5			Undefined
5	Conductor / wire	FALSE	GNYE	1,5			PE

ÖLFLEX® SERVO 2YSLCY-JB 4G2,5



Figure 7 for example LAPP (0036426) or similar

Row	Function definition	Intrinsically safe	Connection color / number	Connection: Cross-section / diameter	Shielded by	Pair index	Potential type
1	Cable definition	FALSE					
2	Conductor / wire	FALSE	BN	2,5	SH		Undefined
3	Conductor / wire	FALSE	BK	2,5	SH		Undefined
4	Conductor / wire	FALSE	GY	2,5	SH		Undefined
5	Conductor / wire	FALSE	GNYE	2,5	SH		PE
6	Conductor / wire	FALSE	SH				SH

Servo Cable n. Siemens FX 5008



Figure 8 for example LAPP (0025725 / 3x(2x0,14 D) + 4x0,14 + 2x0,5 C) or similar

Row	Function definition	Intrinsically safe	Connection color / number	Connection: Cross-section / diameter	Shielded by	Pair index	Potential type
1	Cable definition	FALSE					
2	Conductor / wire	FALSE	YE	0,14	SH1	1.1	Undefined
3	Conductor / wire	FALSE	GN	0,14	SH1	1.2	Undefined
4	Conductor / wire	FALSE	SH1		SH		SH
5	Conductor / wire	FALSE	BK	0,14	SH2	2.1	Undefined
6	Conductor / wire	FALSE	BN	0,14	SH2	2.2	Undefined
7	Conductor / wire	FALSE	SH2		SH		SH
8	Conductor / wire	FALSE	RD	0,14	SH3	3.1	Undefined
9	Conductor / wire	FALSE	OG	0,14	SH3	3.2	Undefined
10	Conductor / wire	FALSE	SH3		SH		SH
11	Conductor / wire	FALSE	GY	0,14	SH		Undefined
12	Conductor / wire	FALSE	BU	0,14	SH		Undefined
13	Conductor / wire	FALSE	WHYE	0,14	SH		Undefined
14	Conductor / wire	FALSE	WHBK	0,14	SH		Undefined
15	Conductor / wire	FALSE	BNRD	0,5	SH		Undefined
16	Conductor / wire	FALSE	BNBU	0,5	SH		Undefined
17	Conductor / wire	FALSE	SH				SH

Specific data fields for Relays, contactors

Pay attention to the main definitions in the chapter "[Record type: Part](#)".

Tab: Properties: Contactor data

Voltage <22033>

Here the rated voltage of the contactor coil in Volt, with the corresponding unit [V], is to be entered. If, due to the difference between DC and AC, there are different voltages or voltage ranges, the DC value must be selected.

The input is limited to 10 characters.



Current <22071>

Optional.

Voltage type <22070>

The voltage type of the voltage entered in the Voltage field must be entered here.

The entry is limited to 5 characters and should be selected from the following list:



Tripping current <22075>

Optional

Holding power <22073>

Optional

Max. power dissipation <22074>

Enter the maximum power dissipation of the coil in Watt, with the corresponding unit [W]. This is essential for the thermal calculation in Pro Panel.

Switching capacity <22072>

Optional

Connection point cross-section <22036>

Here, the maximum connectable conductor cross-section (hostile with wire end sleeve) in square millimeter, with the corresponding unit [mm²] must be entered. If the component is only available on the American or Canadian market, select the corresponding [AWG] numerical value without unit.

Tab: Function templates

Detailed information and concrete examples for the presentation and structure of the function template of relay and contactors can be found in the chapter "[Relays, contactors - How to do](#)".

Function definition

The correct function definition must be stored here.

Connection point designations

The correct connection designation of the function must be stored here.

Connection point descriptions

Optional.

The correct connection description of the function must be stored here.

Connection point cross-section / diameter

There is no information to be given here. This information must be stored in the connection diagrams.

Connection dimension

Is reserved for the end user and must not be filled.

Subordinate DT / DT ID <21005>

Is reserved for the end user and must not be filled.

Contact / coil index

If the article has several coils, an index is to be stored here. This index assigns the contacts to the corresponding coils.



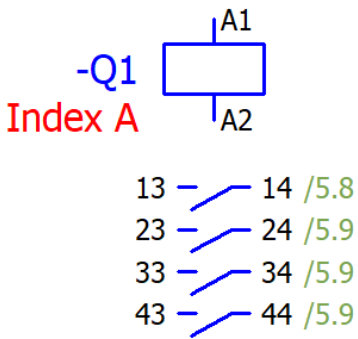

Index A

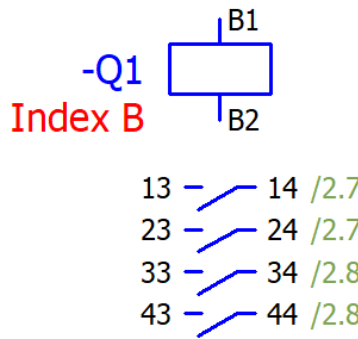

Index B

Row	Function definition	Connection point designations	Contact / coil index
1	Coil for power contactor	A1 A2	1
2	NO auxiliary contact	13 14	1
3	NO auxiliary contact	23 24	1
4	NO auxiliary contact	33 34	1
5	NO auxiliary contact	43 44	1
6	Coil for power contactor	B1 B2	2
7	NO auxiliary contact	13 14	2
8	NO auxiliary contact	23 24	2
9	NO auxiliary contact	33 34	2
10	NO auxiliary contact	43 44	2

Technical characteristics

Must not be filled.

Safety function

If the function is a safety function, the checkbox must be set.

Intrinsically safe

If the contact is intrinsically safe, the checkbox must be set.

Symbol

Is reserved for the end user and must not be filled.

Symbol macro

Optional.

Description

Is reserved for the end user and must not be filled.

Template group (multi-line) <21023>

Optional.

In this field a uniform number or designation for two or more function definitions can be entered. Function definitions with the same Template group designation will be combined into one logical unit. Therefore, if one of these functions is marked in the navigator, all the functions of the template group are placed at the same time - together with the part stored at the macro.

Relays, contactors - How to do

This chapter shows how the function templates for relay and contactors should be designed.

Power contactor (three NO contacts, one NO auxiliary contact)



Figure 9 for example SIEMENS (3RT2015-1BB41)

Row	Function definition	Connection point designations	Connection point cross-section / diameter	Connection dimension	Contact / coil index	Technical characteristics	Safety function	Intrinsically safe	Symbol macro
1	Coil for power contactor	A1 A2					FALSE	FALSE	
2	Power NO contact	1/L1 2/T1					FALSE	FALSE	
3	Power NO contact	3/L2 4/T2					FALSE	FALSE	
4	Power NO contact	5/L3 6/T3					FALSE	FALSE	
5	NO auxiliary contact	13 14					FALSE	FALSE	

Auxiliary contactor (two NO contacts, two NC contacts)



Figure 101 for example SIEMENS (3RH2122-2AB00)

Row	Function definition	Connection point designations	Connection point cross-section / diameter	Connection dimension	Contact / coil index	Technical characteristics	Safety function	Intrinsically safe	Symbol macro
1	Coil for auxiliary relay	A1 A2					FALSE	FALSE	
2	NO auxiliary contact	13 14					FALSE	FALSE	
3	NC auxiliary contact	21 22					FALSE	FALSE	
4	NC auxiliary contact	31 32					FALSE	FALSE	
5	NO auxiliary contact	43 44					FALSE	FALSE	

Specific data fields for Protection devices

Pay attention to the main definitions in the chapter "[Record type: Part](#)".

Tab: Properties: Component data

Voltage <22033>

Here the operating voltage of the contactor coil in Volt, with the corresponding unit [V], is to be stored.

The entry is limited to 10 characters.

Voltage type <22070>

The voltage type of the voltage entered in the Voltage field must be entered here.

The entry is limited to 5 characters and should be selected from the following list:



Current <22071>

Optional

Tripping current <22075>

Optional

Connection point cross-section <22036>

Here, the maximum connectable conductor cross-section (hostile with wire end sleeve) must be entered in square millimeter, with the corresponding unit [mm²]. The information refers to the contacts.

Switching capacity <22072>

Optional

Holding power <22073>

Optional

Max. power dissipation <22074>

Enter the maximum power dissipation of the coil in Watt with the corresponding unit [W]. This is essential for the thermal calculation in Pro Panel.

Tab: Function templates

Detailed information and concrete examples for the presentation and structure of the function template of protection devices can be found in the chapter "[Protection devices - How to do](#)".

Function definition

The correct function definition must be stored here.

Connection point designations

The correct connection designation of the function must be stored here.

Connection point descriptions

Optional.

The correct connection description of the function must be stored here.

Connection point cross-section / diameter

There is no information to be given here. This information must be stored in the connection diagrams.

Connection dimension

Is reserved for the end user and must not be filled.

Subordinate DT / DT ID <21005>

Is reserved for the end user and must not be filled.

Technical characteristics

Must not be filled.

Safety function

If the function is a safety function, the checkbox must be set.

Intrinsically safe

If the contact is intrinsically safe, the checkbox must be set.

Symbol

Is reserved for the end user and must not be filled.

Symbol macro

Optional.

Description

Is reserved for the end user and must not be filled.

Template group (multi-line) <21023>

Optional.

In this field a uniform number or designation for two or more function definitions can be entered. Function definitions with the same Template group designation will be combined into one logical unit. Therefore, if one of these functions is marked in the navigator, all the functions of the template group are placed at the same time - together with the part stored at the macro.

Contact / coil index

Optional.

Protection devices - How to do

This chapter shows how the function templates for protection devices should be designed.

Circuit-breaker 3-pole



Figure 21 for example SIEMENS (5SY4316-7)

Row	Function definition	Connection point designations	Technical characteristics	Safety function	Intrinsically safe	Symbol macro
1	Triple circuit breaker	1¶2¶3¶4¶5¶6		FALSE	FALSE	

Motor overload switch



Figure 32 for example SIEMENS (3RV2011-1DA10)

Row	Function definition	Connection point designations	Technical characteristics	Safety function	Intrinsically safe	Symbol macro
1	Motor overload switch three-pole	1/L1¶2/T1¶3/L2¶4/T2¶5/L3¶6/T3		FALSE	FALSE	

Specific data fields for Connections

Pay attention to the main definitions in the chapter "[Record type: Part](#)".

Tab: Properties: Connection data

Cable type / Type designation <22030> 

Here the cable type (the physical properties of the cable) must be stored.

Entry is limited to 40 characters.



N07V-K

Length (prefabricated) <22055>

Optional.

Unit for connection cross-section / diameter <22068> 

Unit for the cross-section or diameter of the connections of a cable or conduit.



Possible values are predefined and can be taken from the EPLAN Platform Online Help

Voltage <22033>

Optional.

Entry is limited to 10 characters.

External diameter <22065> 

Enter the outer diameter of the connection in millimeters, indicating the unit [mm].

Entry is limited to 15 characters.

Min. bending radius <22063> 

Enter the minimum bending radius of the connection in millimeters, indicating the unit [mm].

Copper weight <22066>

Optional.

Specifies the proportion of copper in the cable.

Entry is limited to 10 characters.

Weight / length <22067>

Optional.

Entry here is relative to the unit [kg/km].

Entry is limited to 10 characters.

Image file <22045> 

A representative product image shall be entered in this field. This is used as a preview image on the EPLAN Data Portal.

Pay attention to the path specifications of the folder structure and file name in the chapter [“General definition > Path specifications: creation of the folder structure and file names / references”](#).

Short-circuit proof <22115>

Optional.

Tab: Function templates

Detailed information and concrete examples for the presentation and structure of the function template of connections can be found in the chapter [“Connections - How to do”](#).

Function definition

The correct function definition must be stored here.

Connection color / number

The color code according to IEC 60757 must be used as designation in case it contains wires with different colors. The codes will be extended according the wire numbering if the cable contains wire of the same color, e.g: BK1, BK2, BK3, RD1, RD2, etc. The color code does not have to be specified, if the cable contains only wires with identical color. In this case only the numbering is indicated: 1, 2, 3, etc. A shielding is generally designated with 'SH'. Multiple shields are numbered in sequence: SH1, SH2, SH3, etc. Under no circumstances, must there be wires with an identical designation. If a color is not listed in the table IEC 60757, a suitable two-digit abbreviation must be selected.

For bright shades, letter 'L' must be placed in front of the existing color code (Light Blue → LBU).

For dark shades, letter 'D' must be placed in front of the existing color code (Dark Blue → DBU).

For cable cores with multiple colors, the combination of colors must be selected from the definition of IEC 60757 from top to bottom. (Red-Blue cable core → RDBU). If a color is dominating, it must be set first. (White cable core with blue stripes → WHBU)

	Black – BK
	Brown – BN
	Red – RD
	Orange – OG
	Yellow – YE
	Green – GN
	Blue – BU
	Violet – VT
	Grey – GY
	White – WH
	Pink – PK
	Turquoise – TQ
	Green-Yellow – GNYE
	Gold – GD
	Silver - SR

Subordinate DT / DT ID <21005>

Is reserved for the end user and must not be filled.

Connection: Cross-section / diameter

In the case of connections, the cross-section without unit is to be indicated here.

Shielded by

Not used for connections.

Pair index

Not used for connections.

Potential type

For PE connections or shields, the correct potential must be specified in the following list. For all other potentials, the selection "undefined" should be selected.



Possible values are predefined and can be taken from the EPLAN Platform Online Help.

Intrinsically safe

Not used for connections.

Pipe class

Not used for connections.

Description

Is reserved for the end user and must not be filled.

Template group (multi-line) <21023>

Optional.

In this field a uniform number or designation for two or more function definitions can be entered. Function definitions with the same Template group designation will be combined into one logical unit. Therefore, if one of these functions is marked in the navigator, all the functions of the template group are placed at the same time - together with the part stored at the macro.

Connections - How to do

This chapter shows how the function templates for connections should be designed.

H07V-K 1X1,5



Figure 43 for example LAPP (4520011) or similar

Row	Function definition	Connection color / number	Connection: Cross-section / diameter	Potential type
1	Conductor / wire	BK	1.5	Undefined

H07V-K 1X1,5 (PE)



Figure 14 for example LAPP (4520001) or similar

Row	Function definition	Connection color / number	Connection: Cross-section / diameter	Potential type
1	Conductor / wire	GNYE	1.5	PE

Abbildung 11 LAPP (4520001) Abbildung ähnlich

Specific data fields for Plugs

Pay attention to the main definitions in the chapter "[Record type: Part](#)".

Tab: Properties: Plug data

Current <22071> 

The rated current of the connector must be stored here.

Plugs: Number of pins <22035> 

Number of pins in the plug.

Plugs: Pin arrangement <22095>

Optional.

Plugs: Clearance <22096>

Optional.

Plugs: Creepage distance <22097>

Optional.

Plugs: Standard / inverse <22098>

Optional.

Plugs: Pin type <22099> 

Optional.

Pay attention to the definition in the chapter "[General definition > Multilingual fields](#)".

Plugs: Type of construction <22100> 

Optional.

Pay attention to the definition in the chapter "[General definition > Multilingual fields](#)".

Plugs: Connecting technique <22101> 

Optional.

Pay attention to the definition in the chapter "[General definition > Multilingual fields](#)".

Plugs: Leading pins <22102>

Optional.

Plugs: Coding <22103> 

Is reserved for the end user and must not be filled.

Connection point cross-section <22036>

Optional.

Tab: Function templates

Detailed information and concrete examples for the presentation and structure of the function template of plugs can be found in the chapter "[Plugs – How to do](#)".

Function definition

The correct function definition must be stored here.

Subordinate DT / DT ID <21005>

Is reserved for the end user and must not be filled.

Terminal / Pin designation

Insert here the designation of a terminal or pin.

Terminal / Pin description

Optional.

Safety function

Optional.

Intrinsically safe

Optional.

Symbol

Optional. If a unique assignment is required, it is recommended to select a symbol from the symbol library here.

Symbol macro

Optional.

Beschreibung

Optional.

Pay attention to the definition in the chapter "[General definition > Multilingual fields](#)".

Template group (multi-line) <21023>

Optional.

In this field a uniform number or designation for two or more function definitions can be entered. Function definitions with the same Template group designation will be combined into one logical unit. Therefore, if one of these functions is marked in the navigator, all the functions of the template group are placed at the same time - together with the part stored at the macro.

Connection point designations

Optional.

Connection point descriptions

Optional.

Connection point cross-section / diameter

Optional.

Connection dimension

Optional.

Plugs - How to do

This chapter shows how the function templates for plugs must be designed.

The function template must be assigned to the connector inserts only (male and female insert). No function template should be assigned to the individual pins.

MALE INSERT



Figure 55 for example HARTING (09330102602)

Row	Function definition	Terminal / Pin designation	Symbol
1	Plug definition for male pins		
2	Male pin, 2 connection point	1	
3	Male pin, 2 connection point	2	
4	Male pin, 2 connection point	3	
5	Male pin, 2 connection point	4	
6	Male pin, 2 connection point	5	
7	Male pin, 2 connection point	6	
8	Male pin, 2 connection point	7	
9	Male pin, 2 connection point	8	
10	Male pin, 2 connection point	9	
11	Male pin, 2 connection point	10	
12	PE male pin, 2 connection point	PE	

FEMALE INSERT



Figure 66 for example HARTING (09330102702)

Row	Function definition	Terminal / Pin designation	Symbol
1	Plug definition for female pins		
2	Female pin, 2 connection point	1	
3	Female pin, 2 connection point	2	
4	Female pin, 2 connection point	3	
5	Female pin, 2 connection point	4	
6	Female pin, 2 connection point	5	
7	Female pin, 2 connection point	6	
8	Female pin, 2 connection point	7	
9	Female pin, 2 connection point	8	
10	Female pin, 2 connection point	9	
11	Female pin, 2 connection point	10	
12	PE female pin, 2 connection point	PE	

Male Crimp contact



Figure 77 for example HARTING (09330006104)

The function template must be empty (see description at the beginning of this chapter).

Female Crimp contact



Figure 88 for example HARTING (09330006204)

The function template must be empty (see description at the beginning of this chapter).

Specific data fields for Enclosure

Pay attention to the main definitions in the chapter "[Record type: Part](#)".

Tab: Accessories

The specification of accessories is optional.

Part is accessory

This checkbox must not be set.

Required

Optional.

Check this box if the part is to contain a mandatory accessory part.

Part number / name

Select a part / part variant or an accessory list from the part selection.

Designation 1

This field is for displaying information only and will be filled automatically after the Part number / name has been chosen.

Variant

The relevant variant number of the part is displayed here. You can overwrite this entry if required.

Record type

This field is for displaying information only and will be filled automatically after the Part number / name has been chosen.

Accessory placement

Optional.

Select the accessory placement that is to be assigned to the respective component. For this purpose, the corresponding accessory placements must have been generated previously in the "Accessory placement" hierarchy level. Pay attention to the chapter "[Record type: Accessory placement](#)".

Note that the Accessory placement property is not available for accessory lists!

Tab: Function definition

Function definition 

Here select the correct function definition for the enclosure.

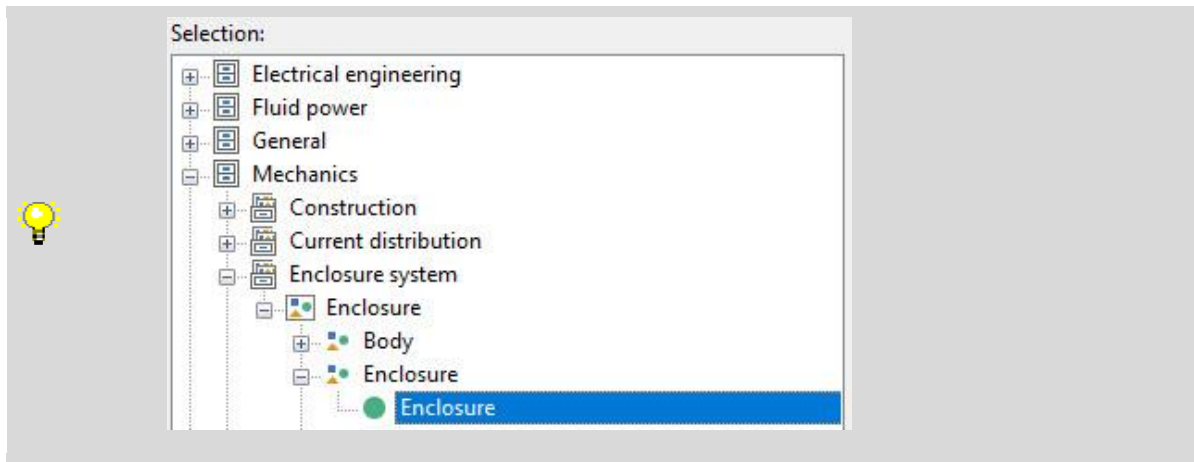

Item

Nothing to do. The value changes automatically after selecting the enclosure function.

Tab: Properties: Housing data

Mounting panel: Usable width <22117>

Optional.

Mounting panel: Usable height <22116>

Optional.

Mounting panel: Max. mounting depth <22118>

Optional.

Mounting panel: Mounting space <22078>

Optional.

Door: Usable width <22120>

Optional.

Door: Usable height <22119>

Optional.

Door: Max. mounting depth <22121>

Optional.

Door: Mounting space <22079>

Optional.

Tab: Properties: Enclosure

Wall thickness <22216>

Optional.

Adjoining distance <22191>

Optional.

Profile horizontal: Height <22187>

Optional.

Profile horizontal: Depth <22188>

Optional.

Profile vertical: Width <22189>

Optional.

Profile vertical: Depth <22190>

Optional.

Tab: Properties: Door

Door: Type <22192>

Optional.

Door: Hinge <22193>

Optional.

Tab: Doors

X/Y/Z position

Optional.

Part number

Optional.

Variant

Optional.

Tab: Mounting panels

X/Y/Z position

Optional.

Mounting location

Optional.

Angle

Optional.

Part number

Optional.

Variant

Optional.

Specific data fields for Cable ducts

Pay attention to the main definitions in the chapter "[Record type: Part](#)".

Tab: Mounting data

Weight

Is reserved for the end user and must not be filled.

Width

Enter here the device-specific width in [mm].

Height

Must be 0,00 mm.

Depth

Enter here the device-specific depth in [mm].

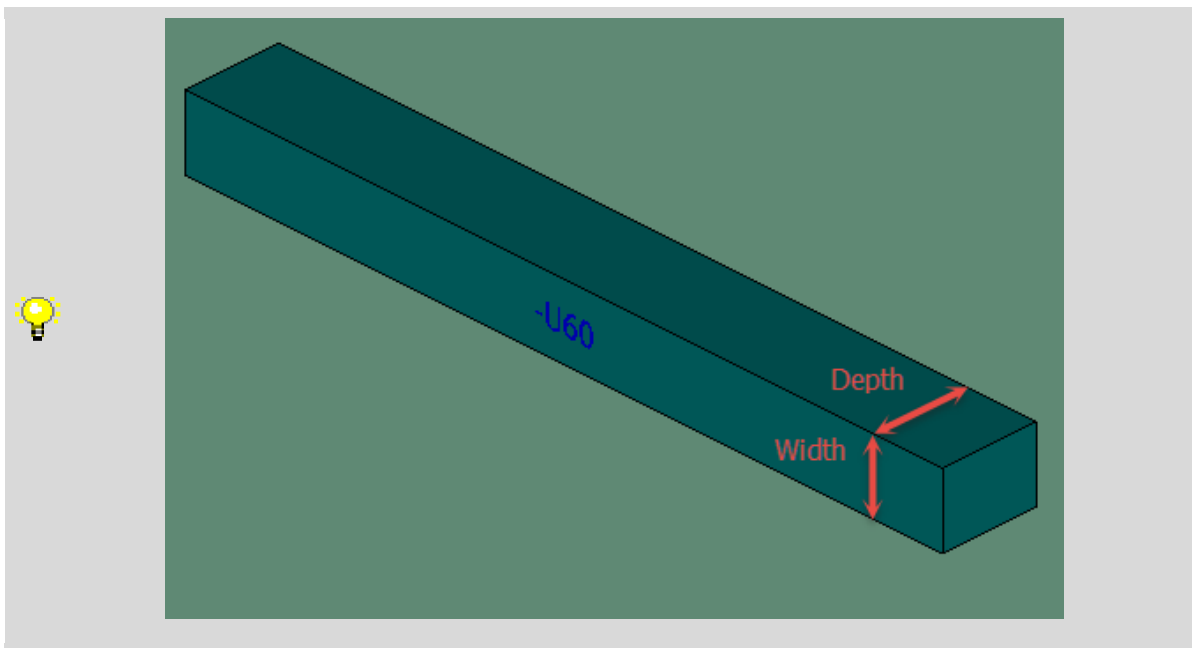

Space requirement

Optional.

This value is calculated when you select [Extras] > Space requirement. The values from the Width and Height fields are used. The following formula is applied: $(w \cdot h)$ where w = width and h = height.

Mounting surface

Is reserved for the end user and should be set to "Not defined"

External placement

Is reserved for the end user and must not be filled.

Graphical macro

Optional.

Pay attention to the path specifications of the folder structure and file name in the chapter "[General definition > Path specifications: creation of the folder structure and file names / references](#)".

Image file

A representative product image shall be indicated in this field. This is used as a preview image on the EPLAN Data Portal.

Pay attention to the path specifications of the folder structure and file name in the chapter [“General definition > Path specifications: creation of the folder structure and file names / references”](#).

Center mismatch

It is not necessary to specify the center offset when using a 3D macro.

Clip-on height

It is not necessary to specify the clip-on height when using a 3D macro.

Mounting depth

It is not necessary to specify the mounting depth when using a 3D macro.

Texture

It is not necessary to specify the texture when using a 3D macro.

Mounting clearance Width / Height / Depth

Is reserved for the end user and must not be filled.

Tab: Manufacturing

Preview

Is reserved for the end user and must not be filled.

Drilling pattern

The correct drilling pattern of the article must be stored here.

Offset in X-direction

A possible offset in X-direction in [mm] is to be indicated here.

Offset in Y-direction

A possible offset in Y-direction in [mm] is to be indicated here.

Tab: Function definition

Function definition

Here select the correct function definition for the Wire duct.

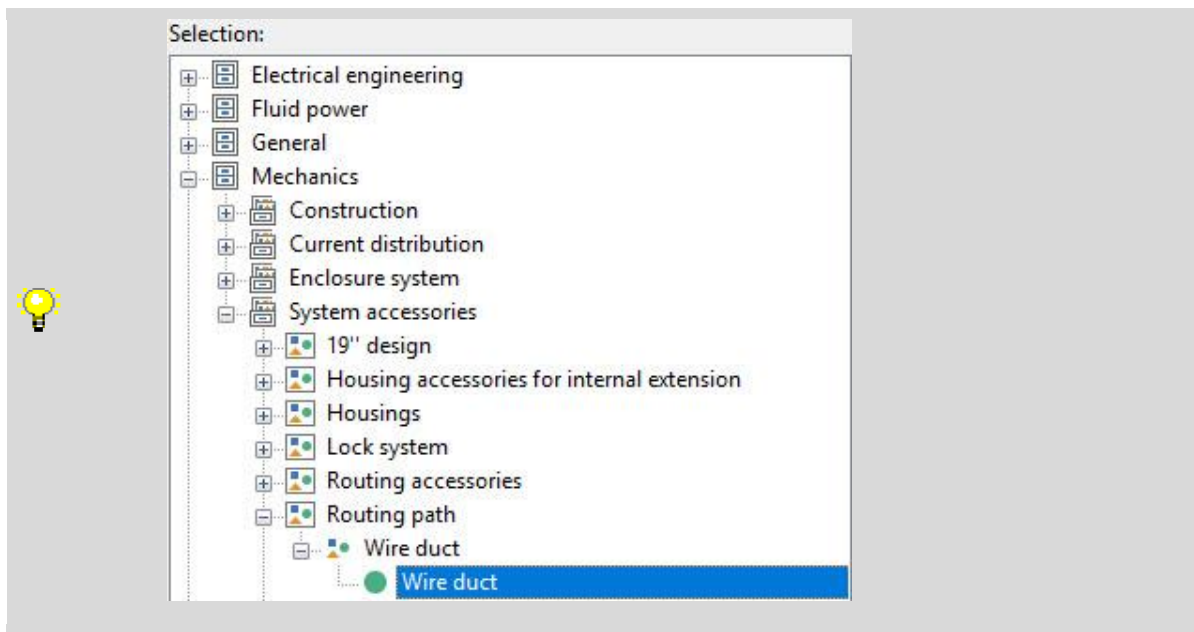

Item

The value changes automatically after selecting the wire duct function.

Tab: Properties: Wire duct data

Delivery length <22058>

This property must be filled only if the item is a length-variable item. Pay attention to the chapter "[General definitions > Length-variable items](#)".

Finger width <22285>

Optional.

Slot width <22286>

Optional.

Distance of the pinch point <22287>

Optional.

Specific data fields for PLC

Pay attention to the main definitions in the chapter "[Record type: Part](#)".

Tab: Properties: Component data

Voltage <22033>

Here the operating voltage of the Card in Volt, with the corresponding unit [V], is to be stored.

The entry is limited to 10 characters.

Voltage type <22070>

The voltage type of the value entered in the "Voltage" field must be entered here.

The entry is limited to 5 characters and should be selected from the following list:



Current <22071>

Optional.

Tripping current <22075>

Optional.

Connection point cross-section <22036>

The maximum connectable conductor cross-section (hostile with wire end sleeve) in square millimeter, with the corresponding unit [mm²], must be entered here.

Pay attention to the definition in the chapter "[General definition > Multilingual fields](#)".

Switching capacity <22072>

Optional.

Holding power <22073>

Optional.

Max. power dissipation <22074>

Enter the maximum power dissipation per Card in Watt (Voltampere) with the corresponding unit [W] (VA). This is essential for the thermal calculation in Pro Panel.

Tab: Properties: PLC data

PLC type designation <22105>

The PLC- type description of the PLC- Card must be entered here. The entry must be made in the exact same spelling as it is used in the manufacturer PLC configuration manual.

Device description: File name <22037>

Enter the file name including file name extensions but without the file path of the device description file of an PLC Card. In addition to the property "Device description: File name" there must be an entry made for the properties "Object description" or "Device description: Index in file". Within the property "Device description: File name" not only GSD-Filenames but also other entries can be stored e.g. the device identification of CC-Link Modules. For this purpose, a prefix followed by a colon must be entered before the actual device identification e.g. "CSP+:AJ65VBTCE2-8T". The entry is then exported unchanged. If the entry includes no prefix (no colon) or the prefix "GSD" e.g. "GSD:SIEM8139.GSD" it will be exported in the AutomationML-Format and interpreted as device description file.

Device description: Index in file <22283>

The index in the device description file of an PLC-Card must be entered here. The Index allows the language neutral selection of a device within such files.

Object description <22038>

Optional.

Version <22104>

Optional.

PLC station type <22269>

Optional.

Bus coupler / head station <22019>

If the card is a bus coupler or head station, the checkbox must be set.

CPU <22020>

If the card is a CPU, the checkbox must be set.

Power supply <22052>

If the card is a power supply, the checkbox must be set.

Bus distribution device <22053>

If the card is a bus distribution device, the checkbox must be set.

PLC card is placed on head station <22290>

Optional.

Drive: Device type <22340>

Is reserved for the end user and must not be filled.

TemplateReference <22338>

Is reserved for the end user and must not be filled.

Address range (SIEMENS STEP 7 Classic) <22106>

Is reserved for the end user and must not be filled.

Address range 2 (SIEMENS STEP 7 Classic) <22261> 

Is reserved for the end user and must not be filled.

PLC device: Data length (inputs) <20571>

Optional.

PLC device: Data length (outputs) <20573>

Optional.

PLC subdevice 1-12: Name <22293 ff.>

Optional.

PLC subdevice 1-12: Position (slot / module) <22305 ff.>

Optional.

PLC subdevice 1-12: Data length (inputs) <22363 ff.>

Optional.

PLC subdevice 1-12: Data length (outputs) <22364 ff.>

Optional.

PLC subdevice 1-12: PLC type designation <22365, 22341 ff.>

Optional.

PLC subdevice 1-12: Device description: Index in file <22366, 22352>

Optional.

Tab: Function templates

Function definition

The correct function definition must be stored here.

Subordinate DT / DT ID <21005>

Optional.

Channel designation <20407>

If available, enter the correct channel designation here. Only whole numbers (1, 2, 3...) should be used for the channel designation.

Safety function <21006>

If this is a safety function, set this checkbox.

Intrinsically safe <21003>

If the function is intrinsically safe, set this checkbox.

Symbol <21001>

Is reserved for the end user and must not be filled.

Symbol macro <21008>

Is reserved for the end user and must not be filled.

Description <20254>

Is reserved for the end user and must not be filled.

Template group (multi-line) <21023>

Optional.

Bus system <20308>

The correct bus system for function definitions that represent a bus connection must be entered here.

Connection point designations <21000>

The designation of the respective function must be entered here.

Connection point descriptions <21007>

The description of the respective function must be entered here.

Connection point cross-section / diameter <21021>

Is reserved for the end user and must not be filled.

Connection dimension <20374>

Is reserved for the end user and must not be filled.

Plug designation <20406>

The correct plug designation of the function must be entered here.

Signal range <20388>

Optional.

PLC subdevice: Index <20384>

Optional.

Macro presentation

In addition to the already mentioned 3D-representation types of a Macro, there are following required representation types and variants to represent a PLC in a circuit diagram. The macros or their fragments stated here, can be used from the “EDS_Macroproject_20211029” macro project as a template. The corresponding property arrangements are also stored here and can be changed only if necessary (e.g. due to overlapping texts, text protrudes from the PLC / black box, etc.). The PLC type number is an exception. If it protrudes from the macro due to its length, the function “Fit text in position frame” can be executed. The property arrangement is prepared accordingly and were designed so that font size as well as font colour can be changed from within the layer management. If it is desired to have additional representation types of Macros, excluding the already listed ones, these can be created in the macro variants which are not mentioned here.

Overview – Variant A to D

This representation type is used to display the overview of the Card. There should not be displayed more than 16 inputs or outputs per variant. Associated power supply connections of the card can be displayed in addition to the inputs or outputs in its corresponding Variant. If a card has more than 16 inputs or outputs, an additional variant must be created.

In this case, the second overview macro must be displayed also in Variant A. Only if a third overview macro is necessary, the Variant B must be used.

The order of placement of the connections should be made according to the following order (alphanumeric – numbers before letters):

- Plug designation
- Channel designation
- I/O connection points
- Power supply
- Card power supply
- Bus connection points
- Connection designation

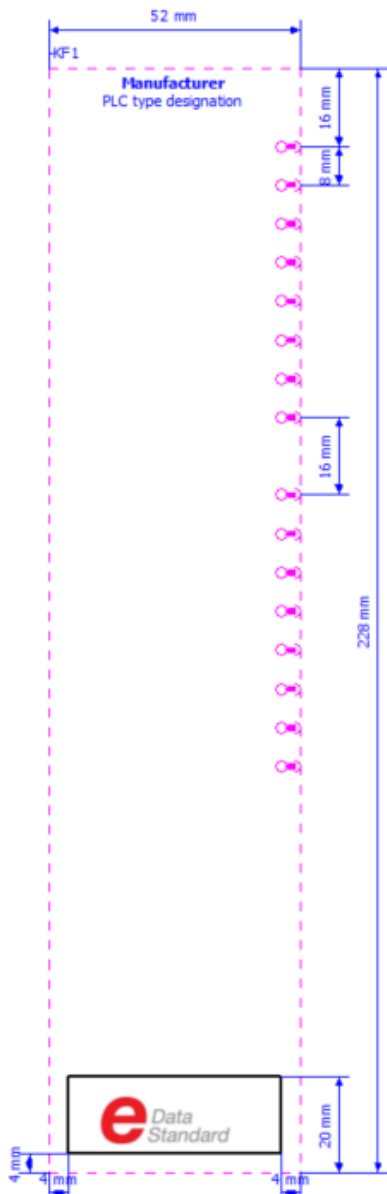

Figure 12 Dimensions overview macro

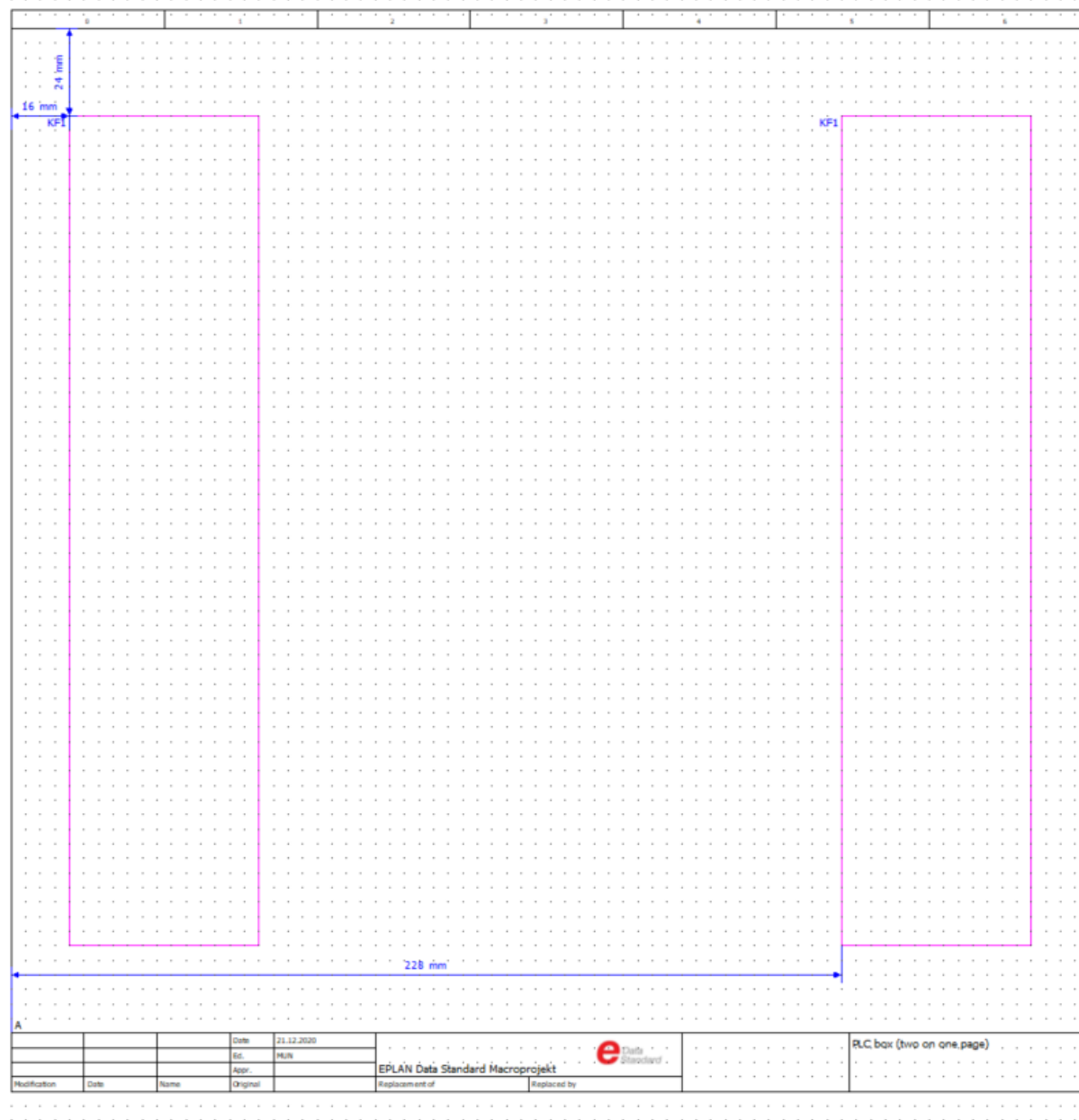

Figure 13 Arrangement of two overview macros on one page

The connections must be consistently displayed with the presentation type "Overview" and must be aligned to the right. The displayed properties can be referred to from the following figure and are pre-set by the prescribed property arrangement.

Channel Adr  Plug_Designation:CP_Designation Sybolic address Function text
CP_Description

A selection of diverse possible connection types is deposited in the macro project mentioned above.

Overview – Variant E

In this representation type, the rack representation of the card must be displayed. There are no connections allowed and the PLC-Box must be carried out in the representation type "Overview". The dimensions of the PLC-Box and the position of the manufacturer logo (in valid formats: .jpg .jpeg .png) are prescribed and must not be changed. The displayed data is pre-set by the property arrangements and show values (e.g. PLC-Station name, CPU: Name, etc.) which are deposited in the corresponding properties of the main function. Describing Headings in the rack representation itself, are deposited in the "Supplementary fields [200] - [204]" of the PLC-Box in all available display languages of the EPLAN Platform.

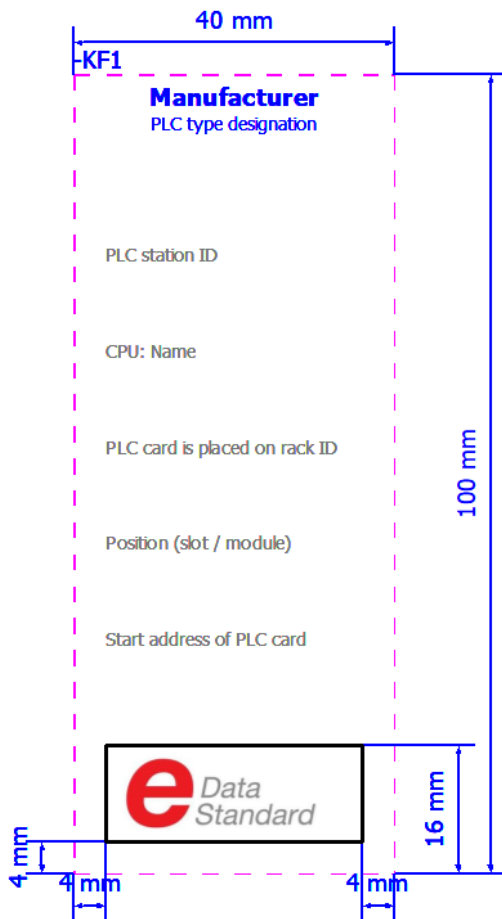

Figure 14 Rack display overview

Multiline

To ensure easy interchangeability, always use the symbol "352 / PLC_CBOX_LEFT" and - if necessary - in connection with the symbol "351 / PLC_CBOX_CON" for the multiline representation and place them at a distance of 8 mm from each other (see Figure 16). This could be found as a template in the macroproject mentioned above. If the connection type of the connection changes, others than the one just mentioned are available in the macroproject. The corresponding propertie arrangement is stored and must not be changed. The following properties are displayed and comply with the requirements of the IEC 61082-1 standard:

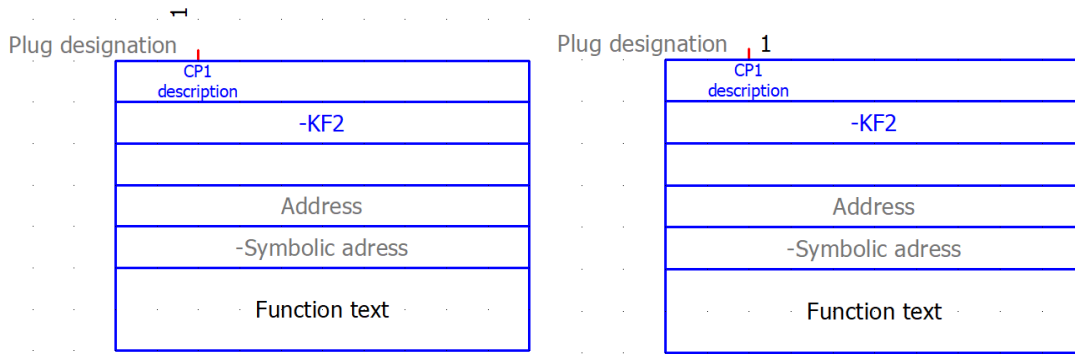

Figure 15 Multiline, Variant A (with and without activated setting "Display rotated connection designation ")

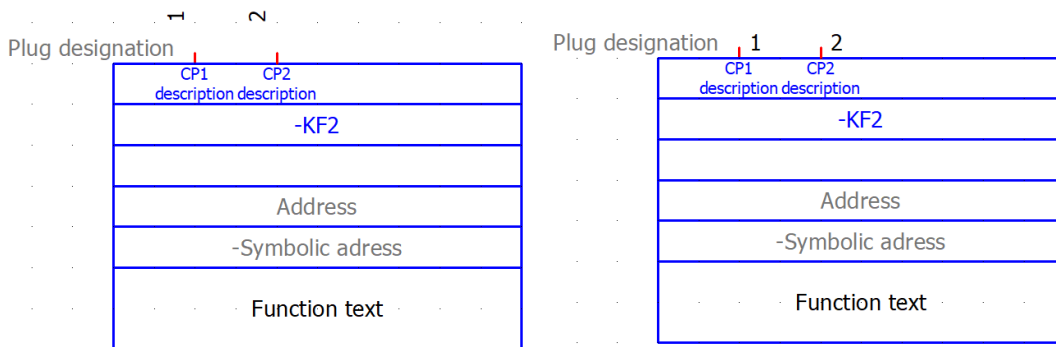

Figure 16 Multiline, Variant B (with and without activated setting "Display rotated connection designation ")

Single-line

The single-pole macro variant is used to display any bus structures. This type of representation must only be created if the corresponding article has at least one bus connection. Several possible PLC boxes in the "single-line" representation type with different dimensions (each 40 mm wide) must be used, depending on whether one, two or more single-line connections are represented. The displayed properties comply with the IEC 61082-1 standard and are preset by the property arrangement and must not be changed.

The connections must all be displayed in the "Single-line" representation and are oriented downwards. A selection of various possible connection types as well as PLC boxes are stored in the macro project mentioned above.

The following properties must be considered at the bus connection:

ID	Property	Value
20406	Plug designation	Mandatory
20447	Bus interface: Name	Mandatory (only for Ethernet-based bus systems)
20308	Bus system	Mandatory
21000	Connection point designation	Do not fill (Exception is, if the bus connection is also shown as multi-line - see How-do-to chapter)
21007	Connection point description	Do not fill (Exception is, if the bus connection is also shown as multi-line - see How-do-to chapter)

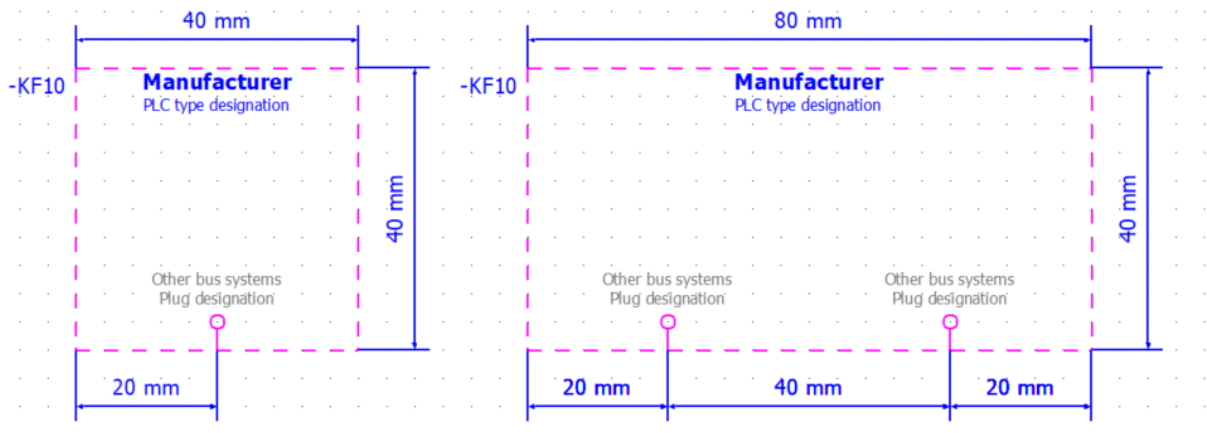

PLC – How to do



Detailed information about the PLC data in EPLAN can be found in the TechTip documents in the EPLAN Online Information Portal.

Physically existing connections without functionality (nc - contacts)

It often happens that there are connections on a device, but they do not provide any functionality (n.c. - not connected). In order to be able to include these correctly in the schematic, however, they must be created with the function definition "PLC connection, general" and the property "Disabled I/O connection <20438>" must be set.

Properties (components): PLC connection points and bus ports

PLC connection point | Display | Symbol / function data

Displayed DT: ... Full DT: =+++KF1 ...

Connection point designation: 16 Connection point description: n.c.

Plug designation: Function text:

Address: ... Symbolic address: ...

Channel designation: Function definition: PLC connection point, general ...

Properties

Category: All categories

Property name	Value
Channel designation (automatic): Suppress search <20578>	<input type="checkbox"/>
Deactivated I/O connection point <20438>	<input checked="" type="checkbox"/>

OK Cancel Apply

Bus connection point

Displaying Bus Ports in Single-line and Multi-line

If a bus connection is not connected via a plug but via individual connection points, it is necessary to provide a multi-line representation in addition to the single-line representation. For this purpose, the macro project provides multi-line bus connection points (IMPORTANT: one symbol) and a PLC box. In the function template, the bus connection point is represented by one function template (connection designation is filled). At least three lines are required in the connection point pattern (at least one per connection).

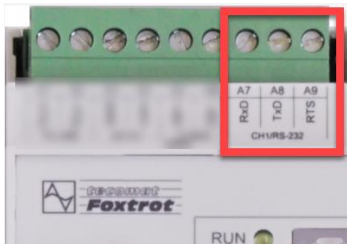
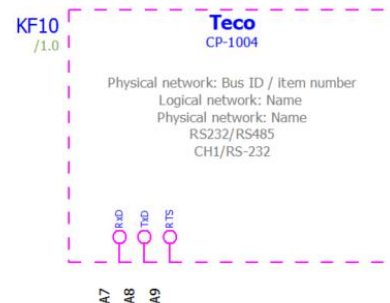
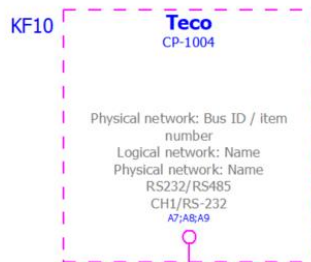
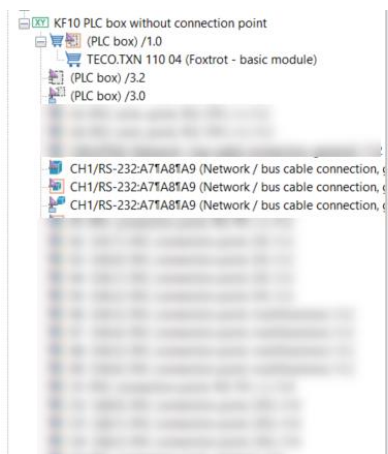
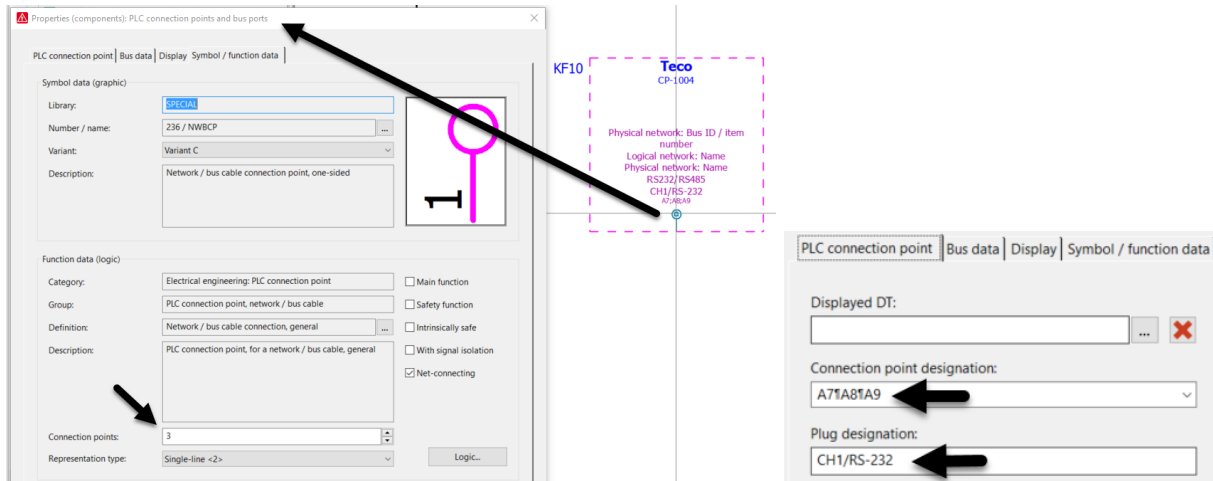

Figure 17 Teco (TXN 110 04)



How to do

The number of connection points must be entered in the properties of the single-line bus connection point (Tab: Symbol / functional data) and the corresponding connection point designation (here A7|A8|A9) must be filled.



The same applies to the multi-line representation. Make sure that the information is identical (number of connection points / connection point designation):

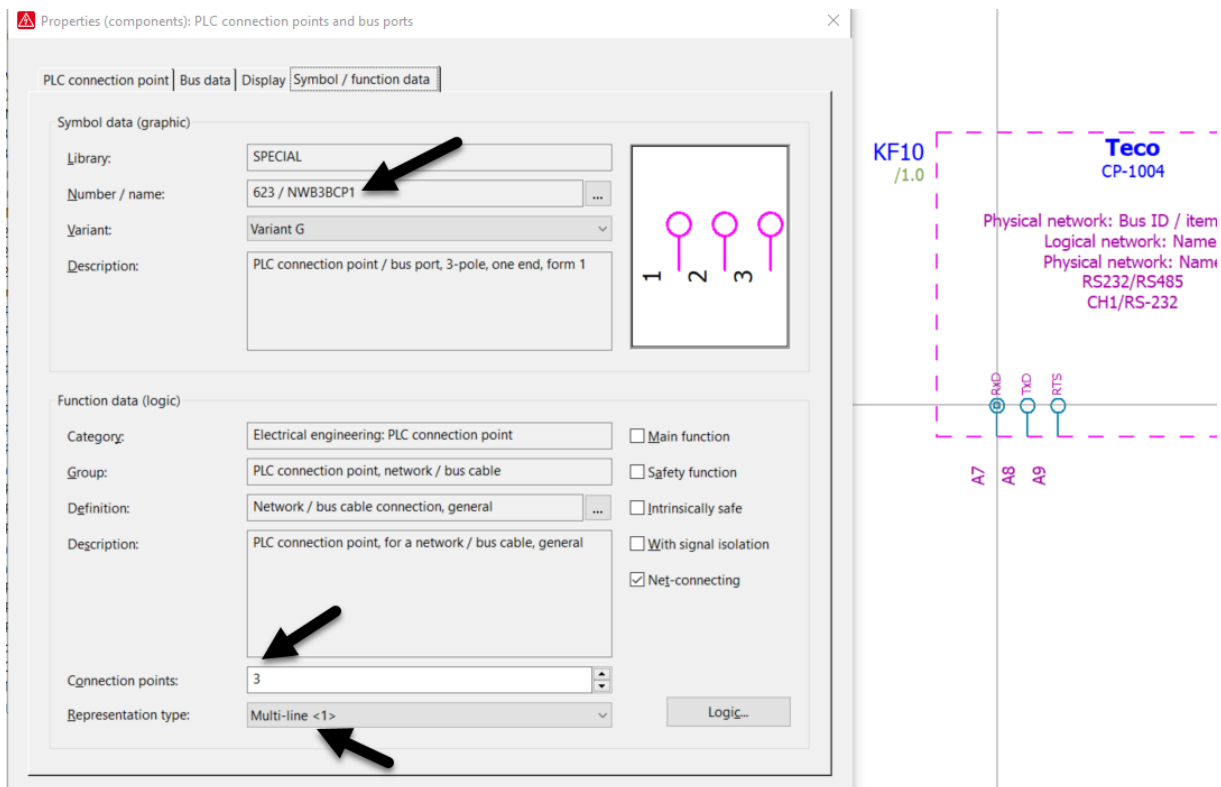

Specific data fields for Fluid Power

In this tab, you specify the specific data for individual part articles in the "Fluid Power" product group. This data can be set several times for each article. The differentiation is made using the variants.

Pay attention to the main definitions in the chapter "[Record type: Part](#)".

Tab: Properties: Fluid

Max. Working pressure <22124>

The maximum operating pressure of the component (entered in [bar]) is entered here. The specification of the unit is automatically added.

Attention: An exception applies to this property for the product group "Subplates". The definition of "Max. working pressure" depends on the trade definition. If the hydraulics trade has been selected, the field is mandatory. If the trade pneumatics was selected, the specification of a value is optional.

The entry is limited to 16 characters.

Max. working pressure <22124>	16,00 bar
-------------------------------	-----------

Control range <22125>

Enter the control range for the operating pressure here. The unit is [bar].

The entry is limited to 16 characters.

Control range <22125>	8,00 bar
-----------------------	----------

Flow <22126>

Enter here how many liters per minute can flow through the component.

The entry is limited to 16 characters.

Flow <22126>	3200,00 l/min
--------------	---------------

Thread <22127>

The thread size of the connection is specified here.

The input is limited to 16 characters. E.g. G 1/4", G 2 1/2", M8.

Thread <22127>	G 3/8"
----------------	--------

Thread <22127>	3/8" - 24 UNF
----------------	---------------

External diameter <22065>

The external diameter is determined here. Unit is in [mm]. This property is only used for connections. This property is used to calculate the degree of filling of cable ducts or installation areas.

The entry is limited to 16 characters.

Inner diameter <22128>

Enter the value for the inside diameter of a connection in [mm] here.

The entry is limited to 16 characters.

Min. bending radius <22063>

Enter the minimum bending radius here e.g. 5 times the outer diameter. This property is only used for connections for routing in the installation space.

The entry is limited to 40 characters.

Length of stroke <22129>

Used for components with a moveable axis e.g. cylinder. Enter the stroke length in [mm].

The entry is limited to 16 characters.

Length of stroke <22129>	250 mm
--------------------------	--------

Connection point <22130>

Enter the form of the connection of this component here, e.g. Thread, Flange.

Connection point <22130>	Thread
--------------------------	--------

Connection point <22130>	Flange
--------------------------	--------

The entry is limited to 16 characters.

Tab: Function templates

The properties depend on the respective product group and are therefore defined in the respective product-specific tab in the Excel sheet.

Detailed information and concrete examples for the presentation and structure of the function template of protection devices can be found in the chapter "[Fluid parts - How to do](#)".

Function definition

The correct function definition must be stored here.

Connection point designations

The correct connection designation of the function must be stored here.

Connection point descriptions

Optional.

The correct connection description of the function must be stored here.

Connection point cross-section / diameter

There is no information to be given here. This information must be stored in the connection diagrams.

Connection dimension

Optional.

The correct connection dimension of the function must be entered here.

Subordinate DT / DT ID <21005>

Is reserved for the end user and must not be filled.

Technical characteristics

Optional

A technical characteristic can be added here if required.

Safety function

Optional

If the function is a safety function, the checkbox must be set.

Intrinsically safe

Optional

If the contact is intrinsically safe, the checkbox must be set.

Symbol

Is reserved for the end user and must not be filled.

Symbol macro

Optional.

Description

Is reserved for the end user and must not be filled.

Template group (multi-line) <21023>

Optional.

In this field a uniform number or designation for two or more function definitions can be entered. Function definitions with the same Template group designation will be combined into one logical unit. Therefore, if one of these functions is marked in the navigator, all the functions of the template group are placed at the same time - together with the part stored at the macro.

Fluid Parts – How to do

This chapter shows how the function templates and the special data fields for fluid parts should be designed.

Actuators, general



Figure 10 for example FESTO (DSBC-40-250-PPSA-N3)

Row	Function definition	Connection point designations	Connection point cross-section / diameter	Connection dimension	Technical characteristics	Safety function	Intrinsically safe	Symbol macro
1	Black box (fluid)					FALSE	FALSE	
2	Device connection point (fluid), 2 connection points	1		G1/4"		FALSE	FALSE	
3	Device connection point (fluid), 2 connection points	2		G1/4"		FALSE	FALSE	

Fluid control terminal



Figure 11 for example FESTO (MS6-LFR-1/2-D7-CRM-AS)

Row	Function definition	Connection point designations	Connection point cross-section / diameter	Connection dimension	Technical characteristics	Safety function	Intrinsically safe	Symbol macro
1	Black box (fluid)					FALSE	FALSE	
2	Device connection point (fluid), 2 connection points	1		G1/2"		FALSE	FALSE	
3	Device connection point (fluid), 2 connection points	2		G1/2"		FALSE	FALSE	
4	Device connection point (fluid), 2 connection points	3		8mm		FALSE	FALSE	

Special data field for fluid:

Compressed air filters:

<input type="checkbox"/>	Fluid power	
<input type="checkbox"/>	— Max. working pressure <22124>	25,00 bar
<input type="checkbox"/>	— Control range <22125>	16,00 bar
<input type="checkbox"/>	— Flow <22126>	50000,00 l/min
<input type="checkbox"/>	— Thread <22127>	G 2"
<input type="checkbox"/>	— External diameter <22065>	
<input type="checkbox"/>	— Inner diameter <22128>	
<input type="checkbox"/>	— Min. bending radius <22063>	
<input type="checkbox"/>	— Length of stroke <22129>	
<input type="checkbox"/>	— Connection point <22130>	Thread

Fixed displacement pumps:

<input type="checkbox"/>	Fluid power	
<input type="checkbox"/>	— Max. working pressure <22124>	0,60 bar
<input type="checkbox"/>	— Control range <22125>	0,00 bar
<input type="checkbox"/>	— Flow <22126>	1,60 l/min
<input type="checkbox"/>	— Thread <22127>	G 1/4"
<input type="checkbox"/>	— External diameter <22065>	
<input type="checkbox"/>	— Inner diameter <22128>	
<input type="checkbox"/>	— Min. bending radius <22063>	
<input type="checkbox"/>	— Length of stroke <22129>	
<input type="checkbox"/>	— Connection point <22130>	

Specific data fields for Housing

Pay attention to the main definitions in the chapter "[Record type: Part](#)".

Tab: Function definition

Function definition

Select the correct function definition from the 'Housings' function category for the corresponding product subgroup.

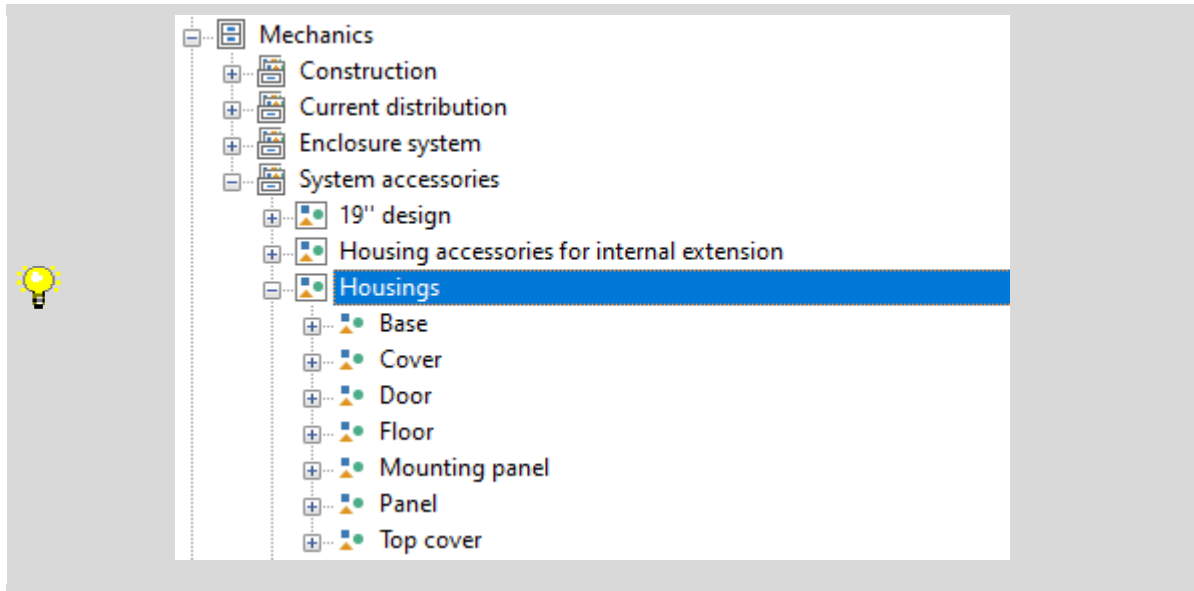

Tab: Properties: Housing data

Mounting panel: Usable width <22117>
Optional.

Mounting panel: Usable height <22116>
Optional.

Mounting panel: Max. mounting depth <22118>
Optional.

Mounting panel: Mounting space <22078>
Optional.

Door: Usable width <22120>
Optional.

Door: Usable height <22119>
Optional.

Door: Max. mounting depth <22121>
Optional.

Door: Mounting space <22079>
Optional.

Tab: Properties: Door

Door: Type <22192>

Optional.

Door: Hinge <22193>

Optional.

Door: Wall thickness <22194>

Optional.

Specific data fields for Housing accessories, internal extension

Pay attention to the main definitions in the chapter "[Record type: Part](#)".

Tab: Mounting data

Pay attention to the chapter "[Record type: Part > Tab: Mounting data](#)" and if the item is a length-variable item pay attention to the chapter "[General definitions > Length-variable items](#)".

Tab: Function definition

Function definition 

Select the correct function definition for the corresponding product subgroup.

C horizontal rail	
Function definition:	Profile rail
Item:	C horizontal rail
Cable clamp rail	
Function definition:	Rail
Item:	User-defined rail
Mounting chassis	
 Function definition:	Chassis
Item:	Chassis
Mounting rail	
Function definition:	Mounting rail
Item:	Mounting rail
Punched rail / Support rails	
Function definition:	Enclosure component
Item:	Enclosure accessories general

Tab: Properties: Mounting rail

Width top <22198>

The width must be indicated here in millimeter with the corresponding unit [mm] for the top.

Width bottom <22199>

The width must be indicated here in millimeter with the corresponding unit [mm] for the bottom.

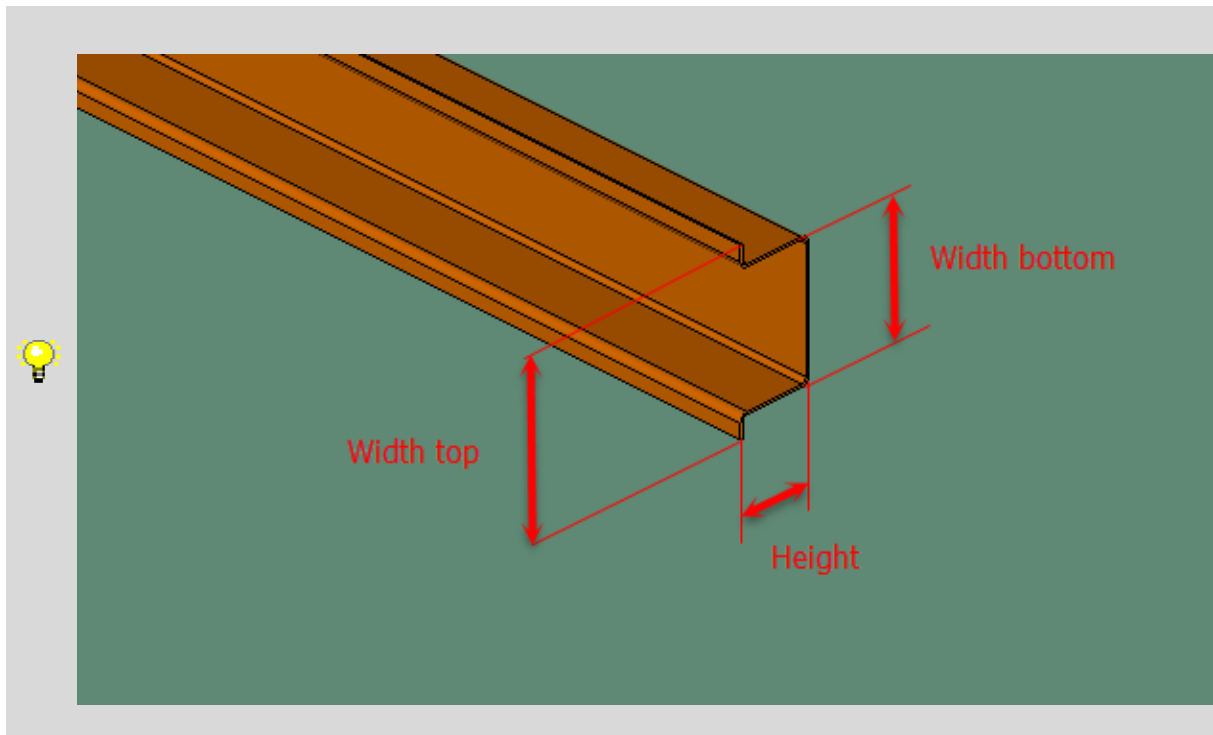
**Delivery length <22058>** 

This property must be filled only if the item is a length-variable item. Pay attention to the chapter "[General definitions > Length-variable items](#)".

This property is not available for 'Mounting chassis', 'Punched rail' and 'Support rails' product subgroups.

Specific data fields for Busbars

Pay attention to the main definitions in the chapter "[Record type: Part](#)".

Tab: Function definition

Function definition

Select the correct function definition from the 'Current distribution' function category for the corresponding product subgroup.

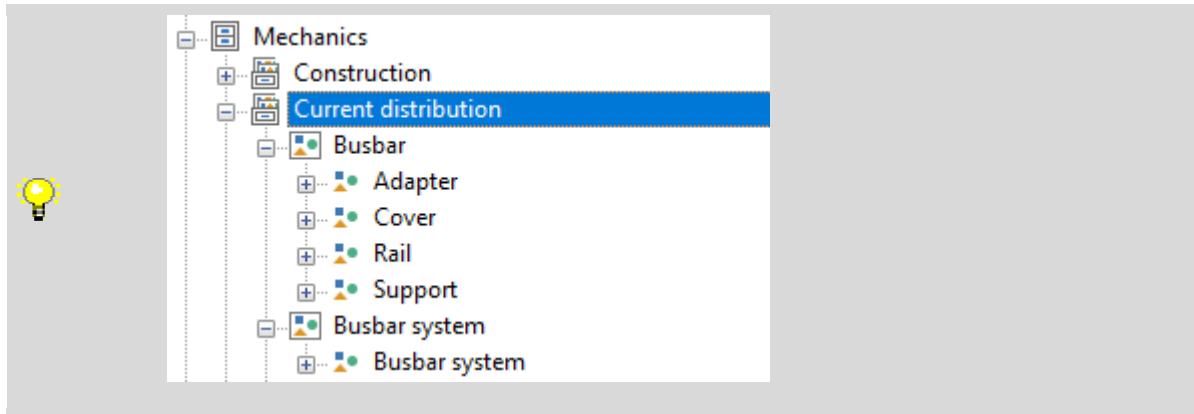

Tab: Properties: Delivery length

Delivery length <22058>

This property must be filled only if the item is a length-variable item. Pay attention to the chapter "[General definitions > Length-variable items](#)".

This property is only available for 'Busbar cover' and 'Rail' product subgroups.

Tab: Properties: Busbar

These properties are only available for the Rail product subgroup and required for the calculation of the busbar power dissipation in Watt [W]. Detailed information can be found in the following help page.

[EPLAN Help > EPLAN Pro Panel > Thermal Design of Switch Gears > Basics > Calculation of the Total Power Dissipation of Switch Gears: Principle](#)

Rail cross-section <22271>

Enter the cross-section of the busbar rail.

Rail material <22272>

Select one of the current three options (copper / aluminum / other material) from the selection list. If you select 'Copper Cu-ETP CW004A' or 'Aluminum, EN AW-1350A' value, the following two properties will be filled automatically with predefined values from software.

Conductivity (at +20 °C) <22273>

Enter the Specific electrical conductivity of the busbar at +20 °C in [MS/m] (= MegaSiemens per meter).

Temperature coefficient <22274>

Enter the Temperature coefficient of the busbar in [1/K] (= per Kelvin). The temperature coefficient applies for a temperature of 20 °C.

Tab: Properties: Busbar system

The following properties are only available for the Rail product subgroups.

Busbars: Part number <22252>

Optional.

Busbars: Part variant <22253>

Optional.

Busbars: Profile geometry D x H (only EPLAN Cabinet) <22200> 

This property must not be filled.

Busbars: Number of rails <22201>

Optional.

Busbars: Rail spacing <22202>

Optional.

Busbars: Distance between rails and mounting panel <22203>

Optional.

Busbar support: Part number <22204>

Optional.

Busbar support: Part variant <22205>

Optional.

Busbar support: Vertical offset <22207>

Optional.

Tab: Mounting rails

The following properties are only available for the System product subgroups.

X Position

Optional.

Y Position

Optional.

Z Position

Optional.

Part number

Optional.

Variant

Optional.

Length

Optional.

Specific data fields for Routing accessories

Pay attention to the main definitions in the chapter "[Record type: Part](#)".

Tab: Function definition

Function definition

Select the correct function definition from the 'Routing accessories' function category for the corresponding product subgroup.

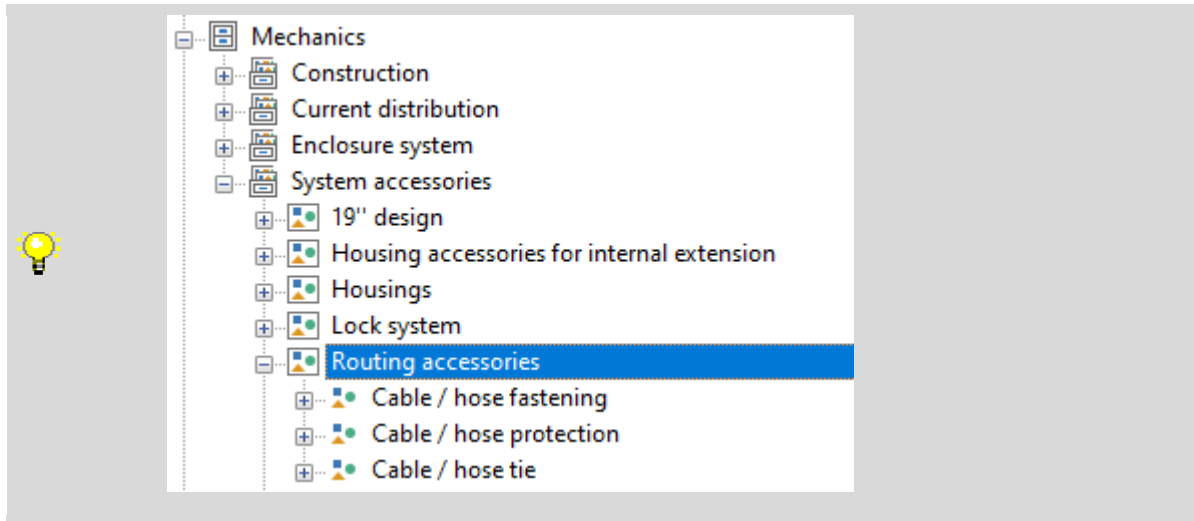

Tab: Properties:

Minimum bundle diameter <22260> 

This property must be filled.

Maximum bundle diameter <22259> 

This property must be filled.

Specific data fields for User-defined rail

Pay attention to the main definitions in the chapter "[Record type: Part](#)".

Tab: Function definition

Function definition

Select the 'Rail' function definition from the 'Housing accessories for internal extension' function category.

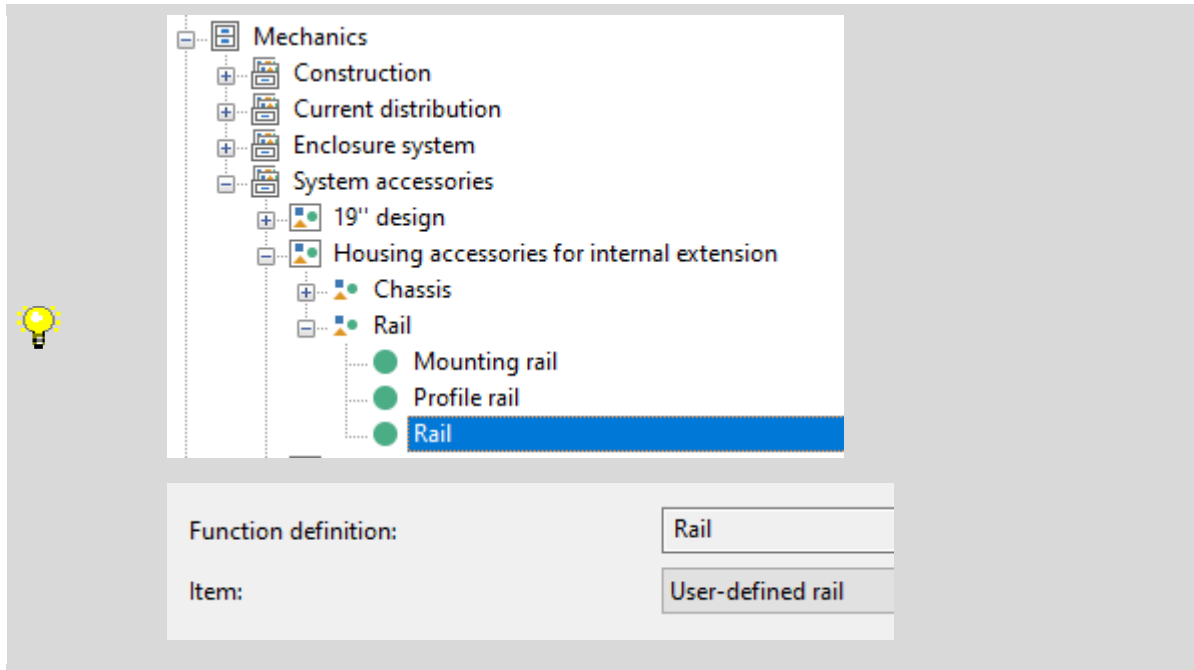

Tab: Properties:

Delivery length <22058>

This property must be filled only if the item is a length-variable item. Pay attention to the chapter "[General definitions > Length-variable items](#)".