

METROFORM SOME INVESTIGATED TO MAKE INTERVALS. YES. COPIES OF THIS DRAWING, GIVING IT TO OTHERS AND THE USE OF THE DRAWING FOR ANY PURPOSES WITHOUT THE EXPRESS WRITTEN PERMISSION OF METROFORM ARE PROHIBITED. METROFORM IS NOT RESPONSIBLE FOR ANY DAMAGES OR LOSSES THAT MAY OCCUR AS A RESULT OF THE USE OF THIS DRAWING. METROFORM IS NOT RESPONSIBLE FOR ANY DAMAGES OR LOSSES THAT MAY OCCUR AS A RESULT OF THE USE OF THIS DRAWING.

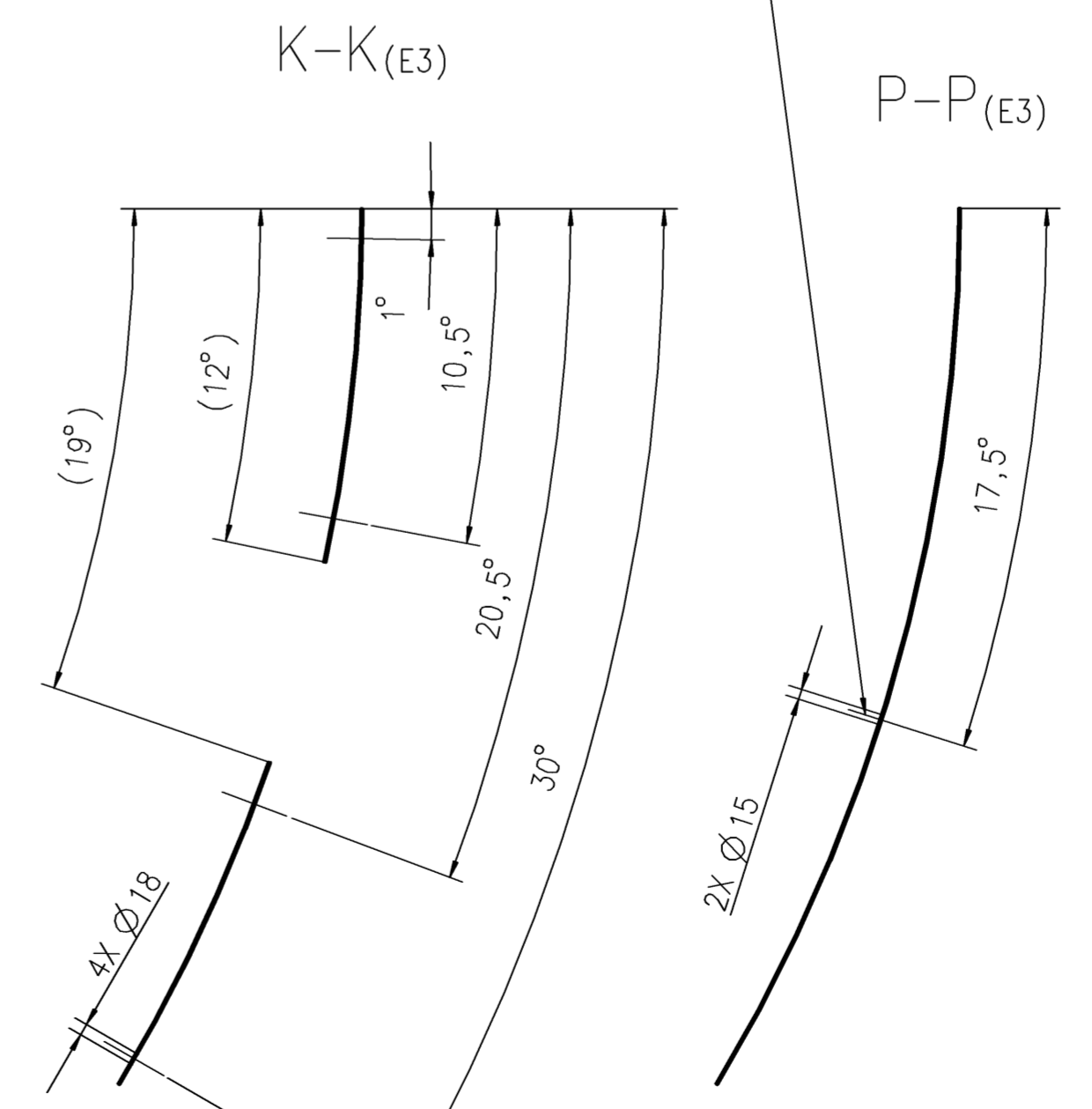
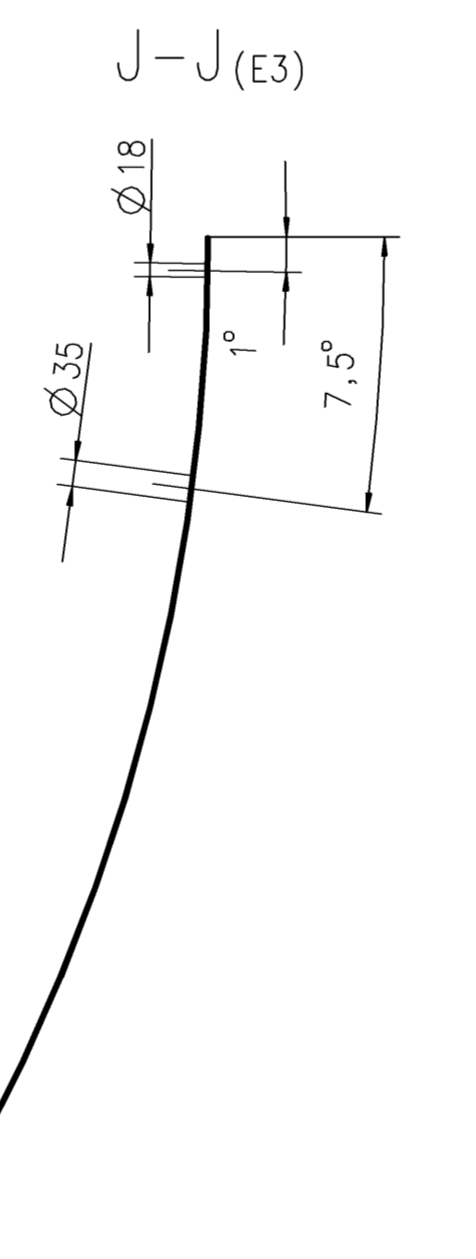
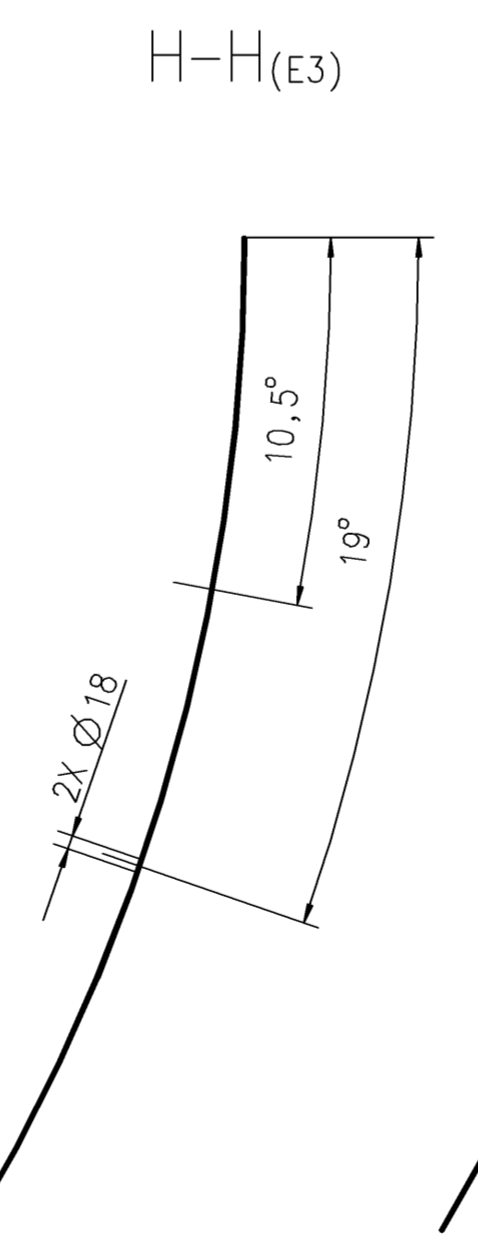
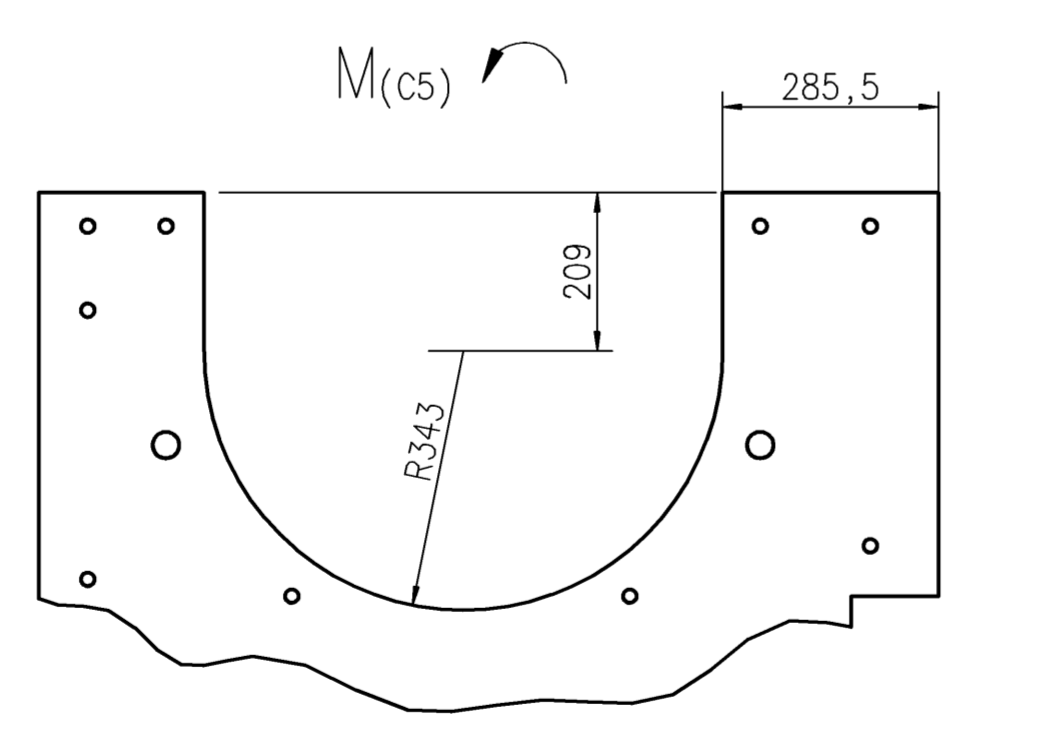
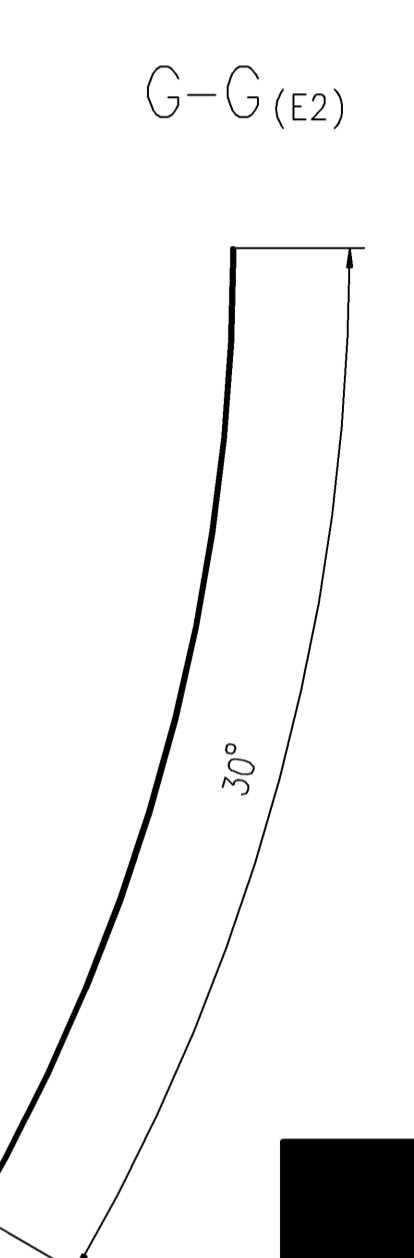
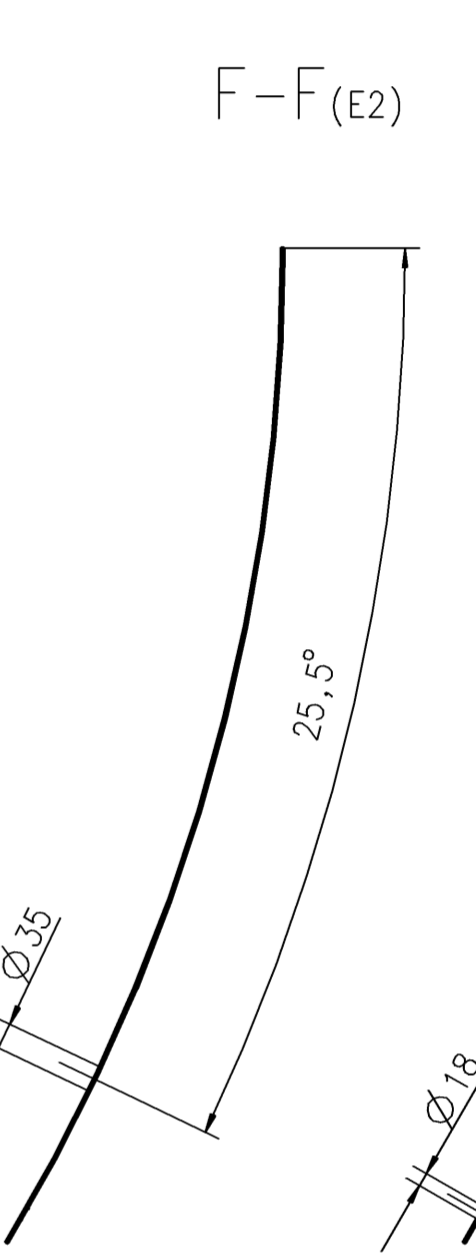
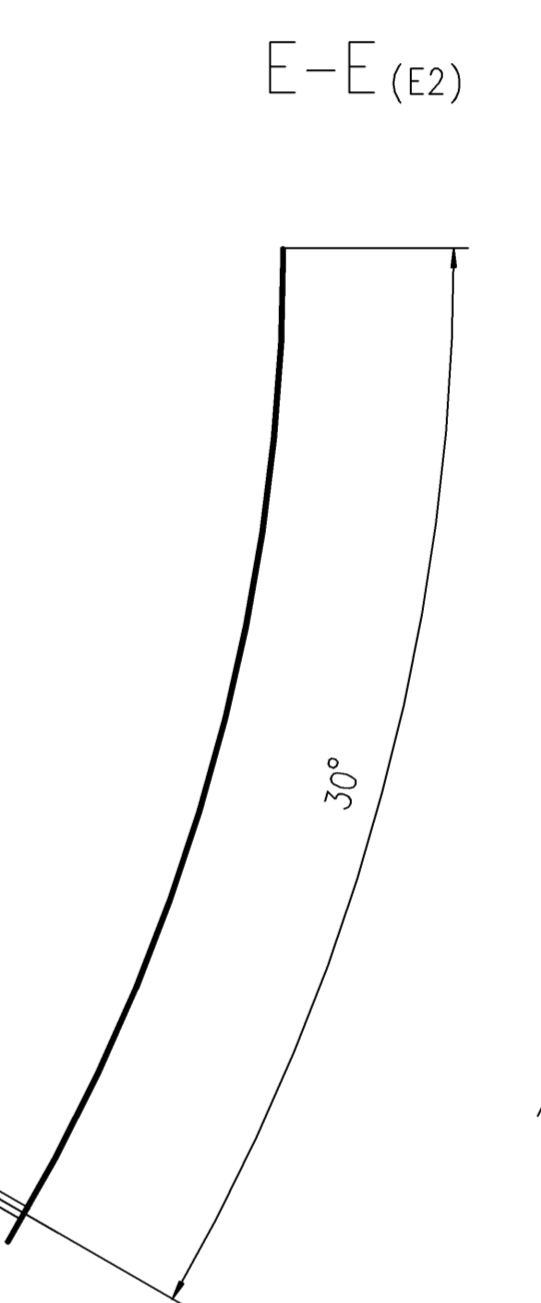
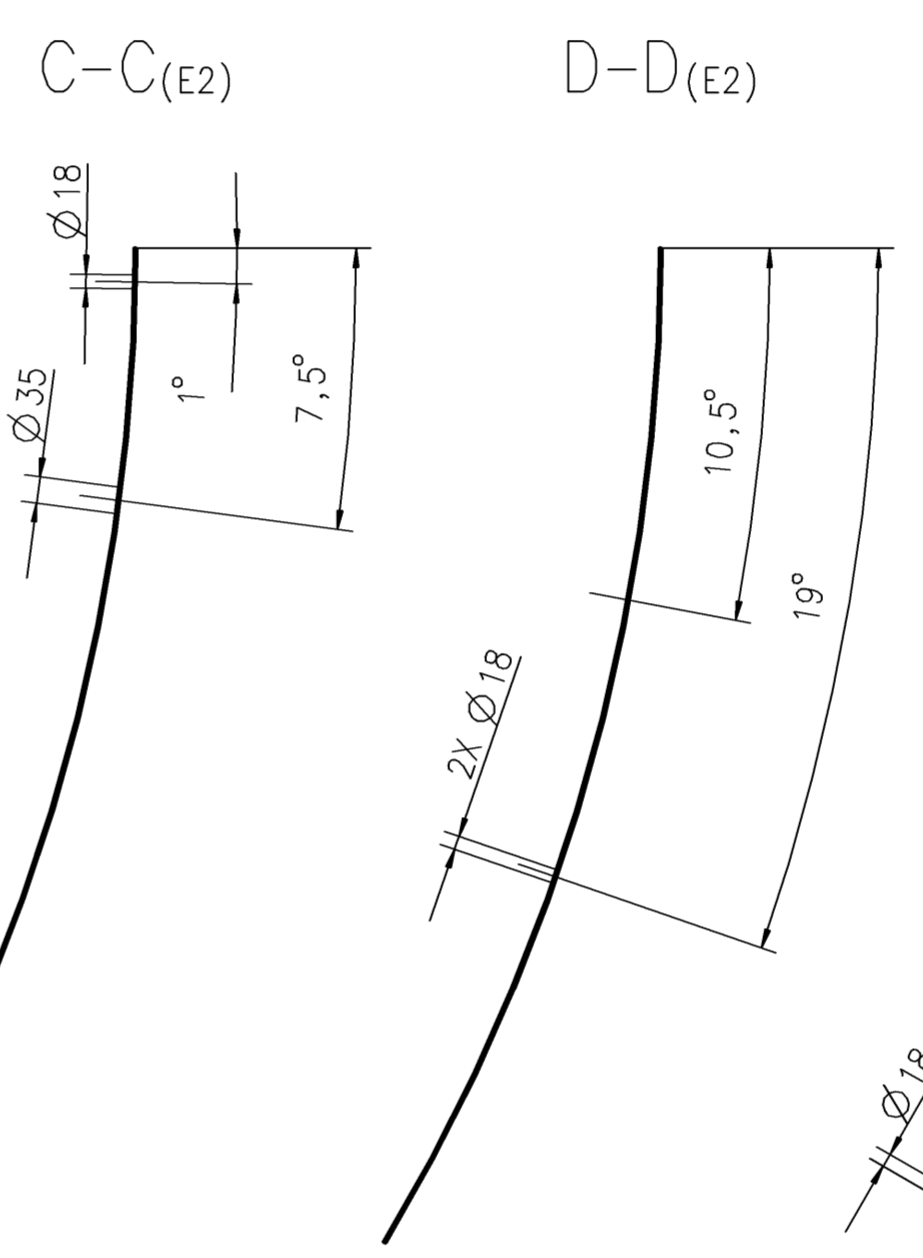
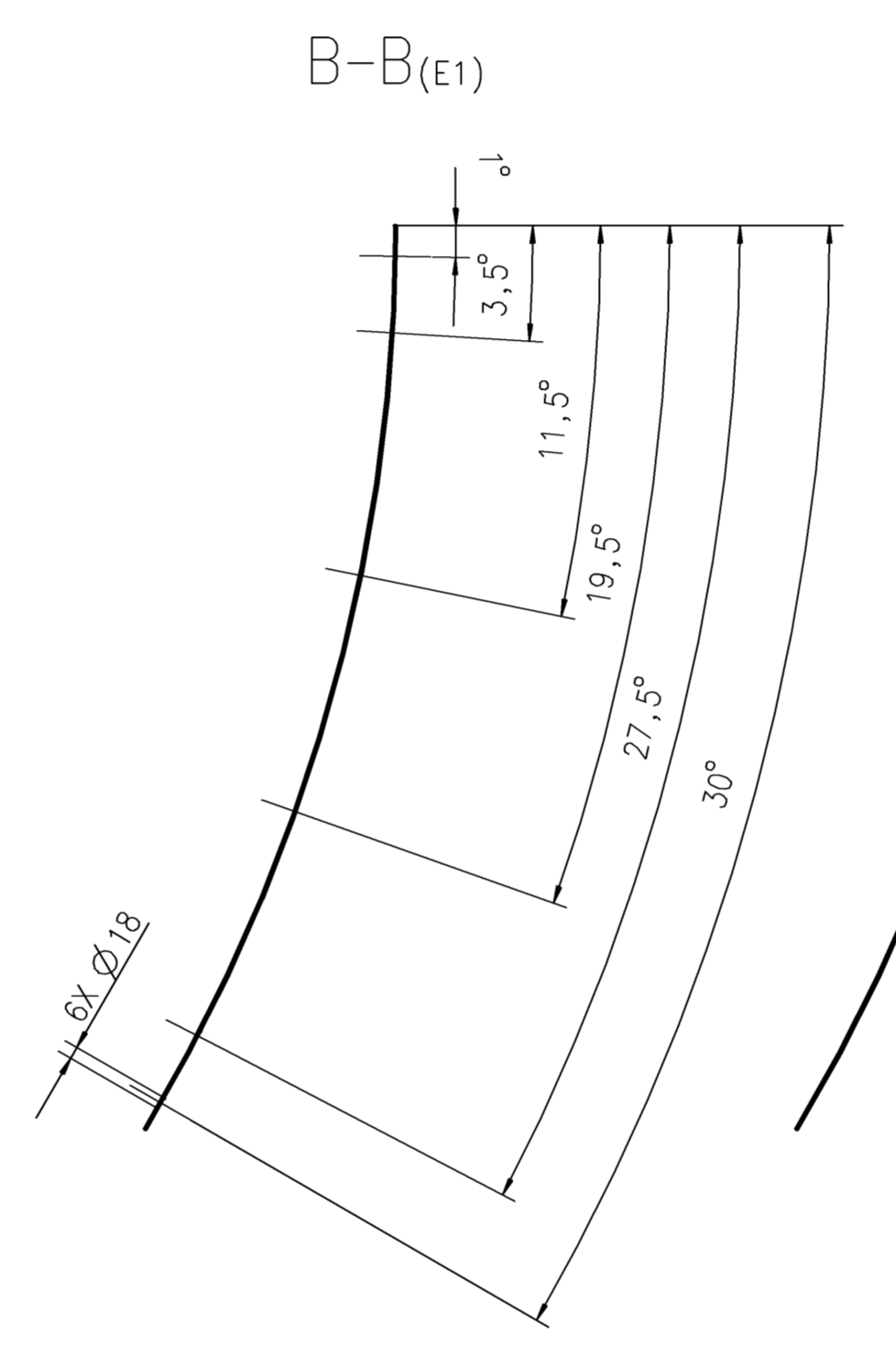
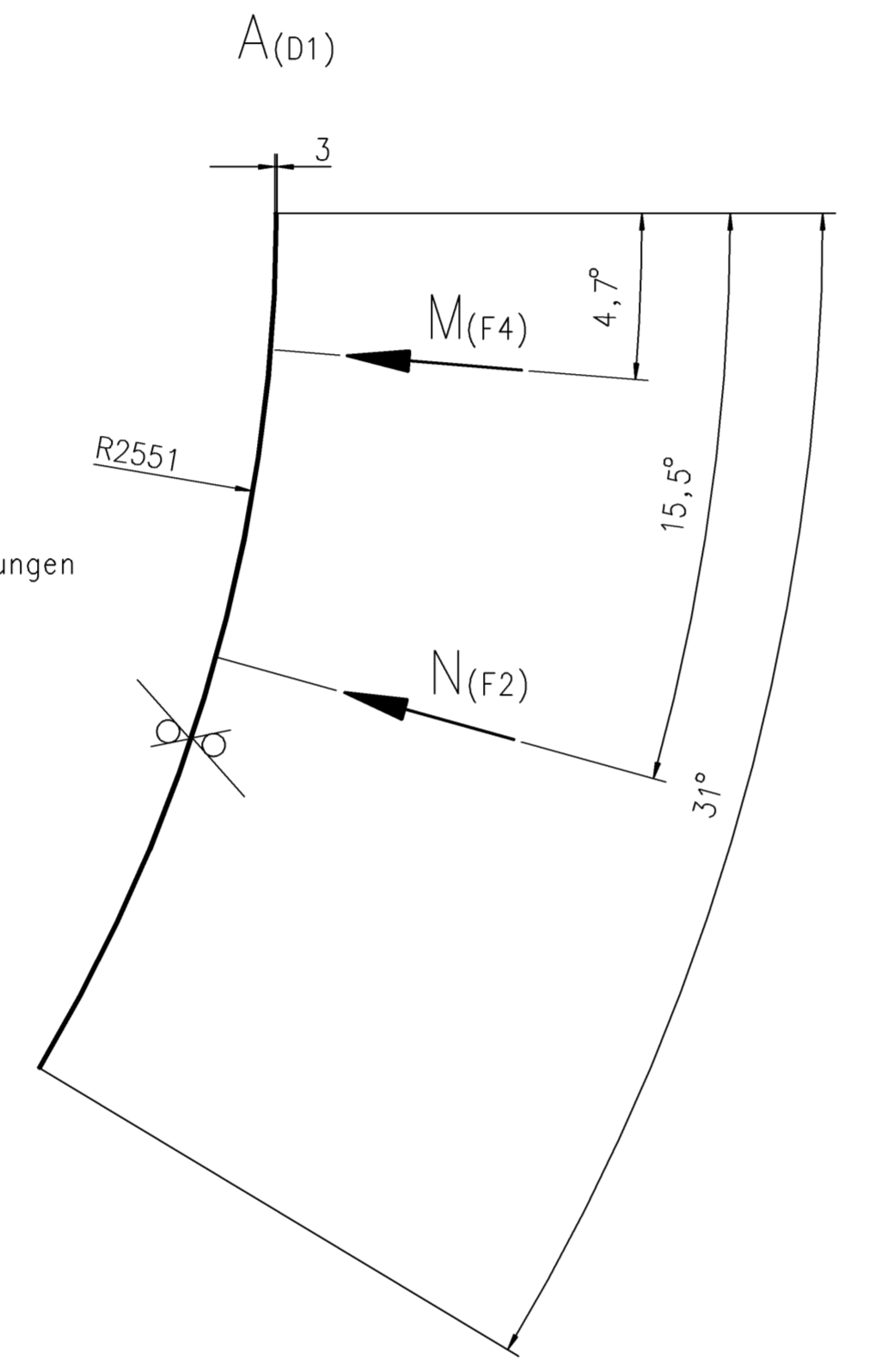
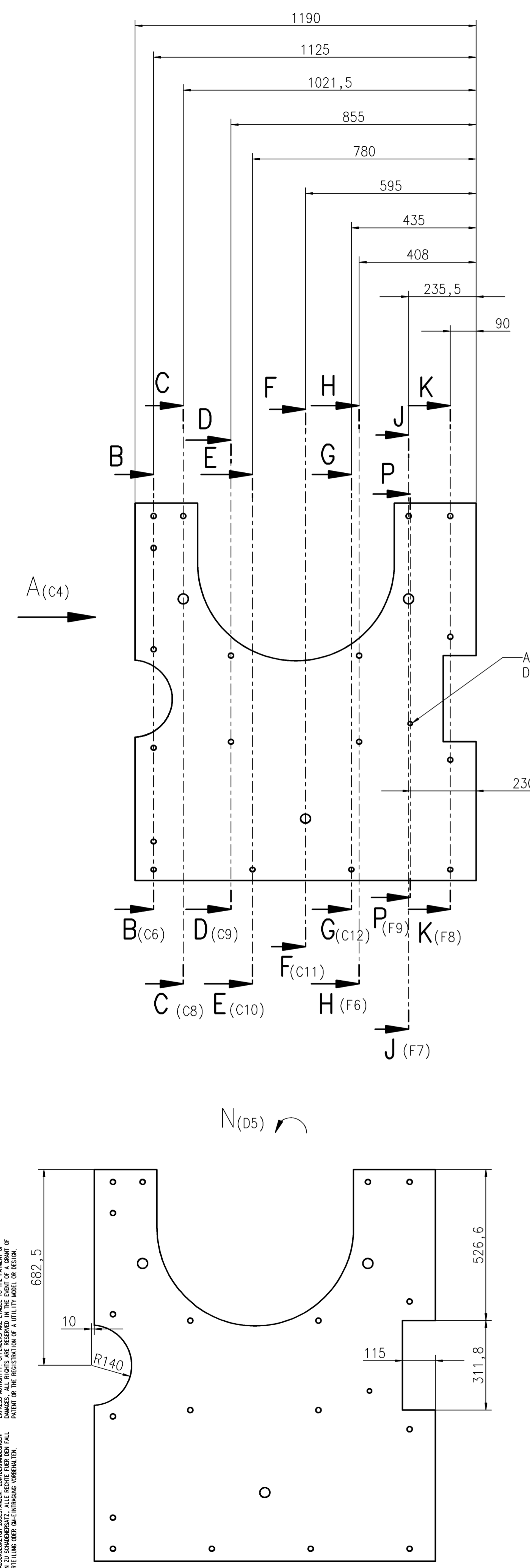

Anmerkungen:  
NOTES:

1. Alle Kanten entgrätet.  
ALL EDGES DEBURRED.
2. Teil beim Zusammenbau bei Bedarf angepasst.  
PART TO BE ADAPTED DURING ASSEMBLY AS NEEDED.
3. Alle Bohrungen  $\sqrt{Rz100}$   $R_{max160}$ .  
ALL DRILLED HOLES TO BE  $\sqrt{Rz100}$   $R_{max160}$ .

bs  $\left( \sqrt{Rz100} \right)$   $R_{max160}$

POSITION OF DRAIN HOLE TO BE ADAPTED AS PER EXISTING HOLE IN INNER CASING

Kennzeichnung nach KUN 107.01  
an mit KZ bezeichneter Stelle im Planquadrat xxx  
Identification according to KUN 107.01  
at the place indicated with KZ of map square xxx

INDEX	DATE	NAME	GEPRUEFT CHECKED	AENDERUNGSBESCHREIBUNG/DESCRIPTION OF CHANGE
c	18-02-11			SEE CHANGE INFORMATION DOCUMENT.
b	10-10-11			SEE CHANGE INFORMATION DOCUMENT.
ENTST.AUS/ORIG.OF		GRUND/REASON		
ZEICHN. DRAHN	DATE	NAME	MASSSTAB SCALE	1:10
2009-04-01				
BEARB. COORD.	2009-04-15		BENENNUNG/TITLE	
2009-04-15			Blech	
GEPRUEFT CHECKED	2009-04-15		PLATE	
ABTLG. DEPT.	MO 4	FORM Z-STY	SPRA.	ZEICHNUNGS-NUMMER/DRAWING NUMBER / KENNWERT/VALUE
		11	14	
N-tech.gepr.	F-tech.gepr.	Design	ch.acc.stand.	ch.acc.prod.
		R. HUDSON	G. GAMBLIN	
Pro/ENGINEER		GES. GEW. IN KG		MF
Klass.: RESTRIKTIV		TOTAL WT.		30.7
				INDEX SEKT.
				c 00

MASSSTAB SCALE 1:10  
 BENEINUNG/TITLE Blech  
 PLATE  
 MO 4  
 FORM Z-STY 11  
 SPRA. 14  
 ZEICHNUNGS-NUMMER/DRAWING NUMBER / KENNWERT/VALUE 1114  
 INDEX SEKT. c 00  
 Design R. HUDSON G. GAMBLIN  
 GES. GEW. IN KG TOTAL WT. 30.7  
 MF

INDEX				
ENTST.AUS/ORIG.OF				
GRUND/REASON				